

BOARD MEETING DATE: March 6, 2015

AGENDA NO. 30

PROPOSAL: Approve and Adopt Technology Advancement Office Clean Fuels Program Annual Report and Plan Update and Resolution and Receive and File Revised Membership of Technology Advancement Advisory Group 

SYNOPSIS: Each year by March 31, the Technology Advancement Office must submit to the California Legislative Analyst an approved Annual Report for the past year and a Plan Update for the current calendar year. Staff has reviewed the Clean Fuels Program with the Clean Fuels Advisory Group, the Technology Advancement Advisory Group and other technical experts. Additionally, the 2015 Clean Fuels Program Draft Plan Update was presented to the Board for review and comment at its December 5, 2014 meeting. This action is to approve and adopt the final Technology Advancement Clean Fuels Program Annual Report for 2014 and 2015 Plan Update as well as the resolution finding that proposed projects do not duplicate any past or present programs and to receive and file the revised membership of the Technology Advancement Advisory Group.

COMMITTEE: Technology, February 20, 2015; Recommended for Approval

RECOMMENDED ACTIONS:

1. Adopt the attached Technology Advancement Office Clean Fuels Program Plan Update for 2015 and include it in the SCAQMD's Clean Fuels Program;
2. Approve the attached Technology Advancement Office Annual Report for 2014;
3. Approve the attached Resolution finding that the update of the Technology Advancement Office Clean Fuels Program Plan and its proposed projects do not duplicate any past or present programs of specified organizations; and
4. Receive and file membership changes to the Technology Advancement Advisory Group.

Barry R. Wallerstein, D.Env.
Executive Officer

Background

Achieving federal and state ambient air quality standards in the South Coast Air Basin will require emission reductions from both mobile and stationary sources beyond those available from current technologies. The 2012 Air Quality Management Plan (AQMP) relies on a mix of currently available technology as well as the expedited development and commercialization of cleaner mobile and stationary advanced technologies in the Basin to achieve these standards. Specifically, the 2012 AQMP identifies the need for 200 tons/day NO_x reductions to be adopted by 2020 for full implementation by 2023 and in large part focuses control measures on transportation technologies and cleaner fuels with zero and near-zero emissions in order to achieve these reductions. Moreover, if this region hopes to meet the 8-hour ozone standard of 80 ppb and 70 ppb by 2023 and 2032, respectively, it is projected that a 65% reduction in NO_x is required. Additionally, preliminary 2014 data suggests the region may not have reached attainment of the 2014 standard for PM_{2.5}. To meet new or revised measures which may be identified in the 2016 AQMP to achieve the ozone standard and the supplement to the 24-hour PM_{2.5} State Implementation Plan to achieve the PM_{2.5} standard in 2015, the SCAQMD Clean Fuels Program more than ever before must encourage and accelerate advancement of transformative transportation technologies and commercialization of progressively lower-emitting vehicles and fuels.

The SCAQMD Clean Fuels Program, first initiated in 1988 along with establishment of the Technology Advancement Office (TAO), is implemented as a public-private partnership in conjunction with private industry, technology developers, academic institutions, research institutions and government agencies. This public-private partnership has enabled the SCAQMD to historically leverage public funds with outside investment in a ratio of about \$3-\$4 of outside funding to every dollar of SCAQMD funding.

Health and Safety Code (H&SC) Section 40448.5.1 requires that the SCAQMD adopt a plan that describes the expected cost and benefits of proposed projects prior to any Clean Fuels Program expenditure and find that the proposed projects do not duplicate programs of other organizations specified in the H&SC provision. In 1999 SB 98 amended this provision by requiring annual updates to this Plan and 30-day public notice to specified interested parties and the public prior to the annual public hearing at which the Board takes action on the Clean Fuels Program. SB 98 also requires the preparation of an annual report with specified contents. This annual report requires the review and approval by an advisory group and the Board, prior to submittal to specified offices of the California Legislature by March 31 of each year. This legislation also specifies the make-up of the 13-member Clean Fuels Advisory Group (CFAG) and its primary responsibilities to make recommendations regarding the most cost-effective projects that advance and implement clean fuels technology and improve public health. The membership of the CFAG was initially approved by the Board in September 1999. Changes to the composition are reviewed by the Board's Technology Committee on an as-needed basis. Prior to formation of the CFAG, the SCAQMD had formed the Technology

Advancement Advisory Group (TAAG) to review and assess the Clean Fuels Program. The charter and membership of the TAAG was revisited in 1999 with formation of the CFAG so their function would complement each other. The TAAG's charter specifies membership changes must be approved by the Board's Technology Committee. Membership changes to both advisory groups were approved by the Board and Technology Committee, respectively, last year in conjunction with approval of the prior reports.

Proposal

This package includes an adoption resolution (Attachment A), proposed new advisory group members (Attachment B) and one combined document comprising the TAO Clean Fuels Program 2014 Annual Report and 2015 Plan Update (Attachment C). This action is for the Board to approve and adopt the TAO Clean Fuels Program Annual Report and Plan Update. Additionally, as part of the Board's consideration of the Plan Update, the Board must make a finding that the update to the TAO Clean Fuels Program and its proposed projects do not duplicate any past or present programs of specified organizations. The review process by the two advisory groups helps ensure that SCAQMD efforts do not duplicate projects. The advisory groups meet in-person twice a year and are also emailed the documents to review. The advisors are all experts in different fields and are members of national laboratories, state or federal agencies and academicians. Staff is also intimately involved with specific technologies through efforts at state and federal collaboratives, partnerships and industrial coalitions. Finally, staff also invites technical experts to review the Annual Report and Plan Update. Through this wide network, staff is confident there is no duplication of technology projects represented in the Plan Update as required in the H&SC. Attachment A is an adoption resolution making such a finding. Furthermore, staff recommends the Technology Committee approve, and the Board receive and file, one membership change, which was necessitated by a staff departure, to the Technology Advancement Advisory Group. That change is reflected in Attachment B.

Clean Fuels Program Annual Report 2014

The Annual Report covers projects and progress of the Program for Calendar Year (CY) 2014. As discussed earlier, this report addresses all of the requirements specified in H&SC 40448.5.1(d). Specifically, the report includes the following required elements:

- A description of the core technologies that the SCAQMD considers critical to ensure attainment and maintenance of ambient air quality standards and a description of the efforts made to overcome commercialization barriers;
- An analysis of the impact of the SCAQMD's Clean Fuels Program on the private sector and on research, development and commercialization efforts by major automobile and energy firms, as determined by the SCAQMD;
- A description of projects funded by the SCAQMD, including a list of recipients, subcontractors, co-funders, matching state or federal funds and expected and

actual results of each project advancing and implementing clean fuels technology and improving public health;

- The title and purpose of all projects undertaken pursuant to the Clean Fuels Program, the names of the contractors and subcontractors involved in each project and the amount of money expended for each project;
- A summary of the progress made toward the goals of the Clean Fuels Program; and
- Funding priorities identified for the next year and relevant audit information for previous, current and future years covered by the report.

During CY 2014, the Clean Fuels Program executed 65 new projects or studies and modified 7 continuing contracts adding additional dollars to sponsor research, development, demonstration and deployment projects of alternative fuel and clean fuel technologies. The SCAQMD’s contribution to these projects was approximately \$14.3 million, with total project costs of nearly \$64.7 million that includes funding from other governmental agencies, private sector, academia and research institutions. These projects address a wide range of air quality issues with a diverse mix of advanced technologies. Figure 1 shows the distribution of funding committed from the Clean Fuels Program through executed agreements in 2014. It should be noted that the executed agreements typically lag the Board awards due to the time necessary to negotiate contracts. During this phase, project awards may be reduced in scope, encounter delays in execution, or may not be contracted at all due to unforeseen difficulties following Board approval. As such, the funding distribution represents a “snapshot-in-time” of the Clean Fuels Program for the calendar year.

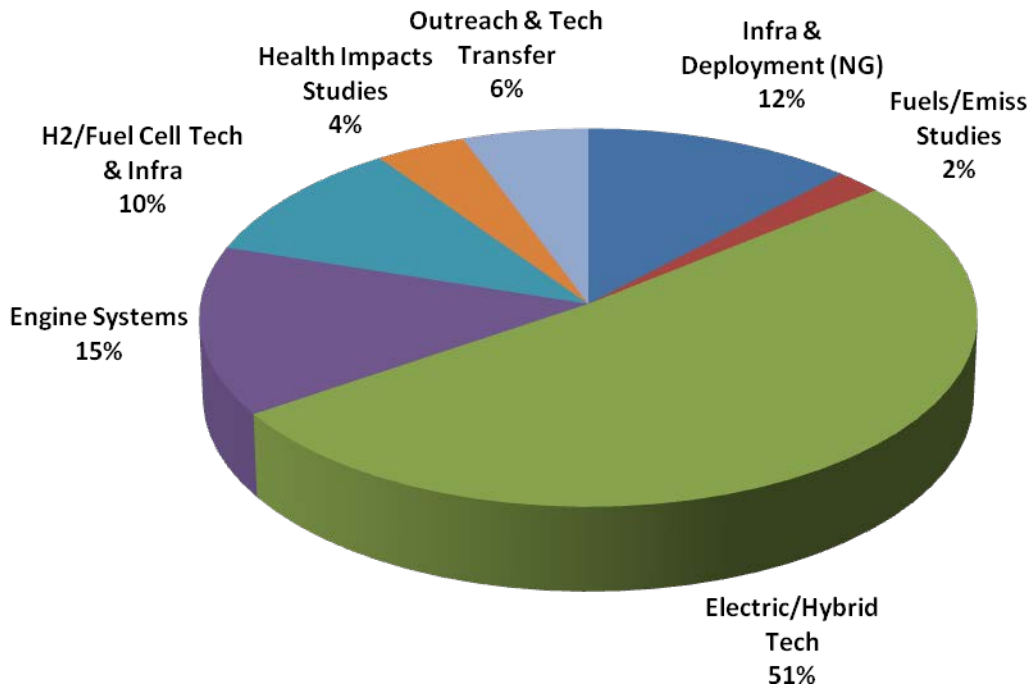

Figure 1: Distribution of Clean Fuels Program Funds in CY 2014 (\$14.3 Million)

During CY 2014, the SCAQMD supported a variety of projects and technologies, ranging from near-term to long-term research, development, demonstration and deployment activities. This “technology portfolio” strategy provides the SCAQMD the ability and flexibility to leverage state and federal funding while also addressing the specific needs of the South Coast Air Basin. Projects executed in CY 2014 included continued development and demonstration of electric and hybrid technologies and infrastructure with an emphasis on zero emission goods movement technologies, development and demonstration of heavy-duty natural gas engines and vehicles, development and demonstration of hydrogen technologies and infrastructure, and three important health studies.

In addition to the new projects, 40 research, development and demonstration projects or studies and 6 technology assessment and transfer projects were completed in CY 2014. Summaries for each of the technical projects are provided in Appendix C of the Annual Report.

The Clean Fuels Program in CY 2014 has continued to leverage other outside opportunities, with the SCAQMD securing awards totaling nearly \$20 million from federal and state funding for projects that will be included in the Clean Fuels Program or which align well with and are complementary to the Clean Fuels Program. Staff will continue to look for and pursue applicable funding opportunities.

Clean Fuels Program Plan Update 2015

Every year TAO staff re-evaluates the Clean Fuels Program to craft a Plan Update which essentially serves to re-calibrate the compass. The attached Plan Update for the Clean Fuels Program identifies potential projects to be considered for funding during 2015 and beyond. The proposed projects reflect promising low and near-zero- or zero emission technologies and applications that are emerging in the different source categories. This Plan Update includes a number of proposed projects, not all of which are expected to be funded in the current calendar year given the available budget. Some of the proposed projects for 2015 include but are not limited to: 1) conversion of a sample fleet to zero emission technologies to demonstrate commercial viability of such technologies; 2) the second phase of demonstrations for Zero Emission Container Transport (ZECT II) technology; 3) medium-duty fuel cell truck development; 4) further evaluation of biofuels including dimethyl ether; 5) partnering with the National Renewable Energy Laboratory (NREL) on fleet and technology matching analysis; 6) development and demonstration of advanced natural gas engines and zero emission technologies for high horsepower applications; and 7) lease of fuel cell vehicles (FCVs) for use in Technology Advancement’s demonstration fleet to promote marketability and demand of FCVs. Projects not funded in 2015 may be considered for funding in future years.

In addition to identifying proposed projects to be considered for funding, this Plan Update confirms nine key technical areas of highest priority to the SCAQMD. These high

priority areas are listed below based on the proposed funding distribution shown in Figure 2:

- Hydrogen and Mobile Fuel Cell Technologies and Infrastructure
- Electric and Hybrid Vehicle Technologies and Related Infrastructure (emphasizing electric and hybrid electric trucks and zero-emission container transport technologies)
- Engine Systems (emphasizing heavy-duty natural gas engines for truck and rail applications)
- Fueling Infrastructure and Deployment (predominantly compressed and liquid natural gas)
- Fuels and Emission Studies
- Outreach and Technology Transfer
- Health Impacts Studies
- Stationary Clean Fuels Technologies (including renewables)
- Emission Control Technologies

It should be noted that these priorities represent the areas where SCAQMD funding is thought to have the greatest impact. In keeping with the diverse and flexible “technology portfolio” approach, however, these priorities may shift during the year to: (1) capture opportunities such as cost-sharing by the state government, the federal government or other entities, (2) address specific technology issues which affect residents within the SCAQMD jurisdiction; (3) incorporate findings from studies, such as SCAQMD’s MATES IV study or the three health impact studies funded in 2014; or (4) further accelerate technology development or commercialization to implement measures that may be identified during development of the 2016 AQMP or the recently drafted supplement to the PM_{2.5} State Implementation Plan.

These technical priorities will necessarily be balanced by funding availability and the availability of qualified projects. Revenues from several sources support the SCAQMD’s Technology Advancement program. The principal revenue source is the Clean Fuels Program, which, under H&SC Section 40448.5 and Vehicle Code Section 9250.11, establishes mechanisms to collect revenues from mobile and stationary sources to support the program’s objectives, albeit with constraints on the use of the funds. Grants and cost-sharing revenue contracts from various government agencies, such as the California Air Resources Board, the California Energy Commission, the National Renewable Energy Laboratory and the U.S. Departments of Energy and Transportation, also support technology advancement efforts.

The proposed Plan Update is the result of a comprehensive planning and review process. This process included consideration of the 2012 AQMP control measures which represent new challenges and methodologies from the prior AQMP. It also incorporates coordination activities involving outside organizations including consideration of federal,

state and local activities and proposed integrated solutions ranging from CARB's freight strategies to proposed new provisions of the Low Carbon Fuel Standard regulation. As part of this process, staff hosted two retreats in August 2014 and January 2015 to solicit input from the Clean Fuels Advisory Group, the Technical Advancement Advisory Group and other technical experts. During these retreats, the participants reviewed the current Technology Advancement projects and discussed near-term and long-term technologies as potential projects. In November 2014, the SCAQMD also hosted a technology forum on air quality sensors to discuss sensor technology, performance and data quality, including technology demonstrations. Additionally, staff attended meetings with CARB, CEC, the California Fuel Cell Partnership, the Transportation Research Board and other entities to solicit and incorporate technical areas for potential leveraged funding and project coordination.

Based on communications with the organizations specified in H&SC Section 40448.5.1 and review of their programs, the projects proposed in this Plan Update do not appear to duplicate any past or present projects. As each individual project is recommended to the Board for funding, staff will continue to coordinate with these organizations to ensure that duplication is avoided and ensure optimal expenditure of Clean Fuels Program funds.

Finally, staff presented the Draft 2015 Clean Fuels Program Plan Update to the Technology Committee on November 21, 2014, and to the full SCAQMD Board for review and comment at its December 5, 2014 meeting. Feedback from Board Members at the public hearing was used to further refine allocations among the funding priority categories. Figure 2 graphically depicts the potential distribution of SCAQMD Clean Fuels funds, based on projected program costs of \$16.4 million, for the nine project areas discussed above.

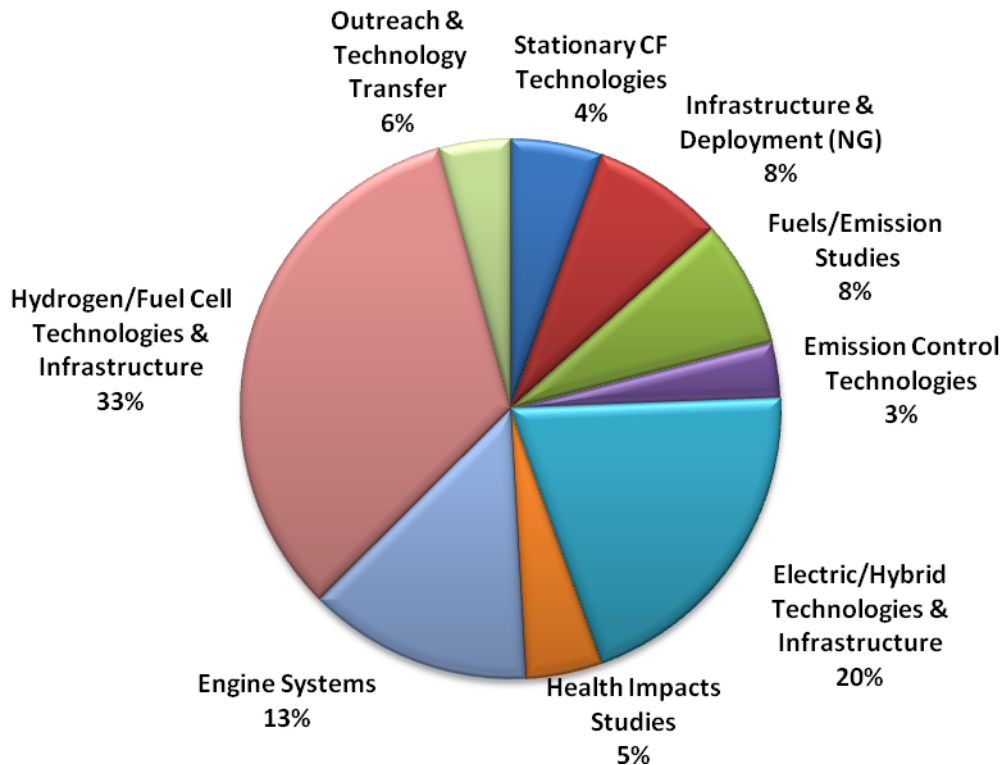

Figure 2: Projected Cost Distribution for Potential Projects in 2015 (\$16.4 million)

The expected actual program expenditures for 2015 will be much less than the total projected program cost since not all projects will materialize. The target allocations are based on balancing technology priorities, technical challenges and opportunities discussed previously and near-term versus long-term benefits with the constraints on available SCAQMD funding. Specific contract awards throughout 2015 will be based on this proposed allocation, the quality of proposals received and evaluation of projects against standardized criteria and, ultimately, the Board’s approval. At that time, additional details will be provided about the technology, its application, the specific scope of work, the project team capabilities and the project cost-sharing.

H&SC Section 40448.5.1 requires the Board approve the Clean Fuels Annual Report for 2014 and adopt the Clean Fuels Plan Update for 2015 as well as find that the proposed projects do not duplicate programs of other organizations specified in the H&SC provision. And as required, the Annual Report and Plan Update have been reviewed and approved by the SB 98 Clean Fuels Advisory Group and is due to the state by March 31, 2015.

Attachments

- A. Resolution
- B. Qualifications and Expertise of Proposed New Advisory Group Members
- C. TAO Clean Fuels Program 2014 Annual Report and 2015 Plan Update

ATTACHMENT A

RESOLUTION NO. 15-

A Resolution of the Governing Board of the South Coast Air Quality Management District (SCAQMD) approving the Technology Advancement Office Clean Fuels Program Annual Report for 2014 and adopting the Clean Fuels Program Plan Update for 2015.

WHEREAS, the Board initiated a Clean Fuels Program in 1988 to expedite the demonstration and commercialization of advanced low emission and zero emission technologies and clean fuels; and,

WHEREAS, Health and Safety Code Sections 40404 and 40448.5 require the SCAQMD to coordinate and manage a Clean Fuels Program to accelerate the utilization of clean-burning fuels within the South Coast Air Basin; and,

WHEREAS, Health and Safety Code Section 40512 and Vehicle Code Section 9250.11 authorize funding for the SCAQMD Clean Fuels Program; and,

WHEREAS, SB 98 (Alarcón), chaptered into state law on June 8, 1999, extended the funding authority for the Clean Fuels Program and added administrative provisions under Health and Safety Code Section 40448.5.1 regarding program planning and reporting, including:

- Providing notice to interested parties and the public at least 30 days prior to the annual public hearing at which the south coast district board or a committee of the board takes action to approve the clean-burning fuels program.
- Consulting with the SB 98 Clean Fuels Advisory Group regarding approval of the required annual report. The results of that consultation shall be provided to the south coast district board prior to its approval of the report.
- Submitting the Clean Fuels Program annual report to the office of the Legislative Analyst and to the committees of the Legislature responsible for improving air quality on or before March 31 of each year that the clean-burning fuels program is in operation.

WHEREAS, SB 1646 (Padilla), chaptered into state law on September 30, 2008, reauthorized the funding authority for the Clean Fuels Program, removed the sunset of January 1, 2010, and reinstated the five percent administrative cap; and,

WHEREAS, the Technology Advancement Office Clean Fuels Program Plan Update has been reviewed and commented on by both the Technology Advancement Advisory Group and the SB 98 Clean Fuels Advisory Group; and,

WHEREAS, Health and Safety Code Section 40448.5.1 requires that the SCAQMD coordinate and ensure non-duplication of clean fuels-related projects with specified organizations, including the: CARB, CEC, California air quality management districts or air pollution control districts, a public transit district or authority within the geographic jurisdiction of the south coast district, San Diego Transit Corporation, North County Transit District, Sacramento Regional Transit District, Alameda-Contra Costa Transit District, San Francisco Bay Area Rapid Transit District, Santa Barbara Metropolitan Transit District, Los Angeles Department of Water and Power, Sacramento Municipal Utility District, Pacific Gas and Electric Company, Southern California Gas Company, Southern California Edison Company, San Diego Gas and Electric Company, or the Office of Mobile Sources within the U.S. Environmental Protection Agency; and

WHEREAS, based on communications with the organizations specified in Health and Safety Code Section 40448.5.1 and review of their programs, the proposed program and projects included in the Technology Advancement Office Clean Fuels Program Plan Update do not duplicate any other past or present program or project funded by those organizations; and,

WHEREAS, notice has been provided to interested parties and the public at least 30 days prior to the annual public hearing at which the south coast district board is to approve the clean-burning fuels program; and,

WHEREAS, the SB 98 Clean Fuels Advisory Group has reviewed the Technology Advancement Office Annual Report.

NOW, THEREFORE, BE IT RESOLVED, that the Board finds the Technology Advancement Office Clean Fuels Program Plan Update does not duplicate any past or present programs or projects funded by the above-specified organizations.

BE IT FURTHER RESOLVED, that the Board approves the Technology Advancement Office Clean Fuels Program Annual Report for 2014.

BE IT FURTHER RESOLVED, that the Board adopts the Technology Advancement Office Clean Fuels Program Plan Update for 2015.

BE IT FURTHER RESOLVED, that the Board hereby directs staff to forward the Technology Advancement Office Clean Fuels Program Annual Report 2014 and Plan Update 2015 to the California Legislature and the Legislative Analyst by March 31, 2015.

Dated:

Sandra McDaniel, Clerk of the Board

ATTACHMENT B
Qualifications and Expertise of Proposed New Advisory Group Members

Technology Advancement Advisory Group**

<p>Fabiola P. Lao, Coalition for Clean Air</p>	<p>Fabiola P. Lao is the Deputy Policy Director for the Coalition for Clean Air (CCA). Prior to joining CCA, Fabiola served as Associate Organizing Representative for the Sierra Club working on the San Gabriel Mountains Forever campaign. The San Gabriel Mountains were designated a National Monument by President Obama on October 2014, and Fabiola's leadership as chair of the campaign's outreach committee was instrumental in achieving this success. Before working on public lands issues, Fabiola worked on developing policy advocacy campaigns in California for environmental health and environmental justice non-profit organizations. She was Program Coordinator at the Breast Cancer Fund, and Policy Analyst at the Latino Issues Forum. During graduate school she was a Governing Board intern at the South Coast Air Quality Management District. Fabiola has a Master of Public Administration degree from the University of Southern California. She also has dual Bachelor in Arts degrees in Interdisciplinary Studies (Public Health concentration) and Spanish from UC Berkeley. She was also a Fellow of the Women's Policy Institute, a program of the Women's Foundation of California.</p>
<p><i>WSPA rep</i></p>	<p><i>Appointment Pending</i></p>

***The charter of the TAAG requires membership changes to be approved by the Board's Technology Committee.*

ATTACHMENT C

**TECHNOLOGY ADVANCEMENT OFFICE
CLEAN FUELS PROGRAM
2014 ANNUAL REPORT AND
2015 PLAN UPDATE**

**South Coast Air Quality Management District
March 2015**

South Coast Air Quality Management District

Governing Board

Chairman

William A. Burke, Ed.D.
Assembly Speaker Appointee

County Representatives

Michael D. Antonovich
Supervisor, Los Angeles County

Shawn Nelson
Supervisor, Orange County

Janice Rutherford*
Supervisor, San Bernardino County

John J. Benoit**
Supervisor, Riverside County

State Representatives

Dr. Clark E. Parker, Sr.
Senate Rules Committee Appointee

Joseph K. Lyou, Ph.D.
Governor's Appointee

Vice Chairman

Dennis R. Yates*
Mayor, City of Chino
San Bernardino County Cities

Cities Representatives

Joe Buscaino*
Councilmember, City of Los Angeles
City of Los Angeles

Michael Cacciotti
Councilmember, City of South Pasadena
Los Angeles County, Eastern Region

Judith Mitchell*
Councilmember, City of Rolling Hills
Estates
Los Angeles County, Western Region

Miguel A. Pulido*
Mayor, City of Santa Ana
Orange County Cities

Ben Benoit
Mayor, City of Wildomar
Riverside County Cities

Executive Officer

Barry R. Wallerstein, D.Env.

*Technology Committee Members

**Technology Committee Chairman

***South Coast Air Quality Management District
Technology Advancement Office***

Matt Miyasato, Ph.D., Deputy Executive Officer, Science & Technology Advancement
Henry Hogo, Assistant Deputy Executive Officer, Mobile Sources
Laki T. Tisopulos, Ph.D., P.E., Assistant Deputy Executive Officer, Source Testing, Ambient
Monitoring & Laboratory Analysis
Fred Minassian, Assistant Deputy Executive Officer, Technology Advancement Office
Lourdes Cordova Martinez, Community Relations Manager

Al Baez, Program Supervisor
Connie Day, Program Supervisor
Ranji George, Program Supervisor
Joseph Impullitti, Program Supervisor
Lisa Mirisola, Program Supervisor
Vicki White, Program Supervisor

Vasken Yardemian, Sr. Staff Specialist

Walter Shen, Staff Specialist

Brian Choe, Air Quality Specialist
Mark Coleman, Air Quality Specialist
Patricia Kwon, Air Quality Specialist
Von Loveland, Air Quality Specialist
Ashkaan Nikravan, Air Quality Specialist
Shashi Singeetham, Air Quality Specialist
Greg Ushijima, Air Quality Specialist
Mei Wang, Air Quality Specialist

Other Staff Contributors

Philip Barroca, Air Quality Specialist
Lori Berard, Air Quality Specialist
Richard Carlson, Air Quality Specialist
David Coel, Program Supervisor
Wei Li, Air Quality Specialist
Frank Motavassel, Air Quality Specialist
Adewale Oshinuga, Program Supervisor
Jean Ospital, Ph.D., Health Effects Officer, Planning, Rule Development & Area Sources
Randall Pasek, Ph.D., Off-Road Mobile Source Manager
Dean Saito, On-Road Mobile Source Manager

Andrew Yoon, Air Quality Specialist
Greta Grier, Air Quality Inspector II
Arun Kumar, Air Quality Inspector II

Drue Hargis, Senior Public Information Specialist

Laurie Diton, Senior Administrative Secretary
Pat Krayser, Senior Administrative Secretary
Penny Shaw Cedillo, Administrative Secretary
Marjorie Eaton, Secretary
Donna Vernon, Secretary
Lani Montojo, Staff Assistant
Michelle White, Staff Assistant
Benigna Taylor, Contracts Assistant
Ana Troccoli, Contracts Assistant
Deanna Doerr, Senior Office Assistant
Lizette Acosta, Office Assistant

Table of Contents

EXECUTIVE SUMMARY	EX-1
Clean Fuels Program Background & Overview	1
Program Background	1
Program Review	1
The Need for Advanced Technologies & Clean Fuels.....	2
Program Funding	6
2014 Overview	7
Core Technologies	7
Clean Fuels Program Barriers, Scope and Impact	13
Overcoming Barriers.....	13
Scope and Benefits of the Clean Fuels Program.....	14
Strategy and Impact	15
Research, Development and Demonstration.....	16
Technology Deployment and Commercialization	21
2014 Funding & Financial Summary	25
Funding Commitments by Core Technologies	25
Review of Audit Findings	26
Project Funding Detail by Core Technologies.....	27
Project Summaries by Core Technologies	35
Electric/Hybrid Technologies	35
Engine Systems.....	40
Infrastructure & Deployment.....	40
Hydrogen Technology and Infrastructure.....	42
Mobile Fuel Cell Technologies.....	45
Health Impacts Studies	46
Fuels/Emissions Studies	48
Outreach and Technology Transfer	49
Progress and Results in 2014	55
Key Projects Completed.....	55
2015 Plan Update	65
Overall Strategy	65
Funding Scope	66
Core Technologies	68
Target Allocations to Core Technology Areas.....	74
Program Plan Update for 2015.....	75
Funding Summary of Potential Projects	75
Technical Summaries of Potential Projects.....	79
Hydrogen and Fuel Cell Technologies & Infrastructure.....	79
Electric/Hybrid Technologies & Infrastructure	84
Engine Systems.....	90
Infrastructure and Deployment (NG).....	92
Fuels/Emission Studies	95
Health Impacts Studies	99
Stationary Clean Fuel Technologies	102
Emission Control Technologies.....	105
Outreach and Technology Transfer	107

Appendix A

Technology Advancement Advisory Group..... A-1
 SB 98 Clean Fuels Advisory Group A-2

Appendix B

Open Clean Fuels Contracts as of January 1, 2015 B-1

Appendix C

Final Reports for 2014..... C-1

Appendix D

Acronyms D-1

Figures

Figure 1: 2023 NO_x Emissions by Category3
 Figure 2: NO_x Contributors by Sector.....3
 Figure 4: Stages of Clean Fuels Program Projects 14
 Figure 5: Catenary-Accessible Trucks on the Siemens' Test Track in Berlin, Germany 17
 Figure 6: TransPower Electric Drayage Truck.....18
 Figure 7: Class 7 Bucket Truck Equipped with Odyne Plug-In Hybrid Drive System 19
 Figure 8: Typical Heavy-Duty Drayage Truck.....20
 Figure 9: Heavy-Duty NG Engine.....20
 Figure 10: NREL's Fleet DNA Project Logo22
 Figure 11: Hydrogen Dispenser in Diamond Bar.....23
 Figure 12: CDFA/DMS Testing23
 Figure 13: Testing Fuel Cell Vehicles with the New Hydrogen Station23
 Figure 14: LNG Station at Truck Stop Center on Valley Blvd. in Fontana23
 Figure 15: LNG Station at Love’s Travel Stop on Dillon Road in Coachella.....24
 Figure 16: LNG Station under Construction at Arco Truck Stop on Cajalco Expressway
 in Perris24
 Figure 17: Distribution of Funds for Executed Clean Fuels Projects CY 2014 (\$14.3 million)26
 Figure 18: Truck #2 with loaded container provided by Port of LA55
 Figure 19: Location of the sampling sites56
 Figure 20: Seasonal variation in source apportionment of quasi-ultrafine particles
 (dp<0.25 μm) by site57
 Figure 21: Variation in mass-based ROS Activity (ug Zymosan/mg PM) at different sampling
 sites during: (a) spring, (b) summer, (c) fall and (d) winter. Error bars correspond to
 one standard deviation. Dashed lines indicate the average of 9 sampling sites58
 Figure 22: PDU SHR-WGS system59
 Figure 23: SHR-WGS Process Diagram60
 Figure 24: Projected Cost Distribution for Potential SCAQMD Projects in 2015 (\$16.4M).....74

Tables

Table 1: SCAQMD Major Funding Partners in CY 201416
 Table 2: Contracts Executed or Amended (w/\$) between January 1 & December 31, 201428
 Table 3: Supplemental Grants/Revenue Received into the Clean Fuels Fund (31) in CY 2014....31
 Table 4: Summary of Federal & State Funding Awarded between Jan. 1 & Dec. 31, 201432
 Table 5: Projects Completed between January 1 & December 31, 201461
 Table 6: Summary of Potential Projects for 201577

EXECUTIVE SUMMARY

Introduction

The South Coast Air Quality Management District (SCAQMD) is the air pollution control agency for all of Orange County and the urban portions of Los Angeles, Riverside and San Bernardino counties. This region, which encompasses all of the South Coast Air Basin plus small portions of the Mojave Desert and Salton Sea Air Basins, historically experiences the worst air quality in the nation due to the natural geographic and atmospheric conditions of the region coupled with the high population density and associated mobile and stationary source emissions. Recognizing this challenge, in 1988 the state established the SCAQMD's Clean Fuels Program (Program), along with the SCAQMD's Technology Advancement Office (TAO). The Clean Fuels Program affords the SCAQMD the ability to fund the development, demonstration and accelerated deployment of clean fuels and transportation technologies. For over 20 years, using funding received through a \$1 motor vehicle registration fee, the Clean Fuels Program has encouraged, fostered and supported clean fuels and transportation technologies such as hydrogen and fuel cells, natural gas engines and infrastructure, battery electric vehicles, plug-in hybrid electric vehicles and related fueling infrastructure. A key strategy of the Program is its implementation as a public-private partnership in conjunction with private industry, technology developers, academic institutions, research institutions and government agencies. The SCAQMD Clean Fuels Program has traditionally supported a portfolio of technologies, in different stages of maturity, to provide a continuum of emission reductions and health benefits over time.

Health & Safety Code (H&SC) 40448.5.1 requires the SCAQMD to annually prepare, and submit to the Legislative Analyst by March 31, a Clean Fuels Annual Report and Plan Update. The Clean Fuels Annual Report looks at what the Program accomplished in the prior calendar year (CY) and the Clean Fuels Plan Update looks ahead at proposed expenditures for the next CY. This document comprises both the 2014 Clean Fuels Annual Report and the 2015 Plan Update.

The overall strategy of the SCAQMD's Clean Fuels Program is based in large part on technology needs identified through the Air Quality Management Plan (AQMP) process and the SCAQMD Board's directives to protect the health of residents in Southern California, which encompasses approximately 16.8 million people (nearly half the population of California). The AQMP is the long-term "blueprint" that defines:

- the basin-wide emission reductions needed to achieve federal ambient air quality standards;
- the regulatory measures to achieve those reductions;
- the timeframes to implement these proposed measures; and
- the technologies required to meet these future proposed regulations.

The 2012 AQMP identified the need for 200 tons/day oxides of nitrogen (NO_x) reductions to be adopted by 2020 for full implementation by 2023 and in large part focused control measures on transportation technologies and cleaner fuels. These emission reduction needs are further identified in a joint SCAQMD, California Air Resources Board (CARB) and San Joaquin Air Pollution Control District effort, "Vision for Clean Air: A Framework for Air Quality and Climate Control Planning."¹ Moreover, the SCAQMD is currently only one of two regions in the nation recognized as an extreme ozone nonattainment area (the other is San Joaquin Valley). Ozone (smog) is created by a chemical reaction between NO_x and volatile organic compounds (VOC) emissions at ground level. This is especially noteworthy because the largest contributor to ozone is NO_x emissions, and mobile sources (on- and off-road as well as aircraft and ships) contribute to more than three-fourths of the NO_x emissions in this region.

¹ http://www.arb.ca.gov/planning/vision/docs/vision_for_clean_air_public_review_draft.pdf

The daunting challenge to reduce ozone and NO_x requires the Clean Fuels Program to encourage and accelerate advancement of transformative fuel and transportation technologies, leading the way for commercialization of progressively lower-emitting fuels and vehicles. If this region hopes to meet the 8-hour ozone standard (80 ppb) by 2023 (or the revised standard of 75 ppb by 2032), it is projected that a 65% reduction in NO_x is required. The NO_x and VOC emission sources of greatest concern to this region are heavy-duty on-road and off-road vehicles as well as to a lesser extent light- and medium-duty on-road vehicles. In addition to NO_x and VOCs, fine particulate matter (PM_{2.5}) produced from mobile sources must also be reduced. From preliminary 2014 data, it appears the region may not have reached attainment of the 2014 standard for PM_{2.5}. A supplement to the 24-hour PM_{2.5} State Implementation Plan (SIP) will focus on achieving the PM_{2.5} standard in 2015, and a 2016 AQMP will focus on achieving the ozone standards. Given the relationship between NO_x and ozone and possible control strategies that might be identified for PM_{2.5} attainment by 2015, the 2015 Plan Update must emphasize emission reductions in these areas.

In recent years, it has become increasingly clear that the effect of containers through the Ports of Los Angeles and Long Beach and the subsequent movement of goods throughout the region not only have a dramatic impact on air quality but also the quality of life to the communities along the major goods movement corridors. In recognition of these impacts, the SCAQMD has initiated a concerted effort in the last couple of years to actively develop and demonstrate zero and near-zero emissions goods movement technologies, such as electric trucks, plug-in hybrid trucks with all-electric range, zero emission container transport technologies, trucks operating from wayside power including catenary technology and heavy-duty technologies.

The prioritization of these types of projects are emphasized in the 2015 Plan Update portion of the report. The 2014 Annual Report highlights the projects contracted during the previous calendar year and reflects the current status of the program.

2014 Annual Report

During CY 2014 the SCAQMD executed 65 new contracts, projects or studies and modified 7 continuing projects adding additional dollars toward research, development, demonstration and deployment (RDD&D) of alternative fuel and clean fuel technologies. Table 2 (page 28) lists these 72 projects or studies, which are further described in this report. The SCAQMD Clean Fuels Program contributed approximately \$14.3 million in partnership with other governmental organizations, private industry, academia and research institutes, and interested parties, with total project costs of nearly \$64.7 million. Table 3 (page 31) provides information on outside funding received into the Clean Fuels Fund (almost \$6 million in 2014) as cost-share passed through the SCAQMD for the contracts executed in CY 2014. Table 4 (page 32) provides a comprehensive summary of federal and state revenue awarded to the SCAQMD during CY 2014 (nearly \$20 million) for projects to be included within the Clean Fuels Program or which align well with and are complementary to the Clean Fuels Program.

The projects or studies executed in 2014 addressed a wide range of issues and opportunities with a diverse mix of advanced technologies. The following core areas of technology advancement for 2014 executed projects (in order of funding percentage) include:

- Electric and Hybrid Vehicle Technologies and Related Infrastructure (emphasizing electric and hybrid electric trucks and zero emission container transport technologies)
- Engine Systems (particularly heavy-duty natural gas engines for truck and rail applications)
- Fueling Infrastructure and Deployment (predominantly compressed and liquid natural gas)
- Hydrogen and Mobile Fuel Cell Technologies and Infrastructure
- Health Impacts Studies

- Fuels and Emission Studies
- Outreach and Technology Transfer

During CY 2014, the SCAQMD supported a variety of projects and technologies, ranging from near-term to long-term research, development, demonstration and deployment activities. This “technology portfolio” strategy provides the SCAQMD the ability and flexibility to leverage state and federal funding while also addressing the specific needs of the South Coast Air Basin (Basin). Projects executed in CY 2014 included continued development and demonstration of electric and hybrid technologies with an emphasis on zero emission goods movement technologies, development and demonstration of heavy-duty natural gas engines and vehicles, natural gas fueling infrastructure, and development and demonstration of hydrogen technologies and infrastructure.

As of January 1, 2015, there were 121 open contracts in the Clean Fuels Program; these are summarized in Appendix B.

Forty research, development, demonstration and deployment projects or studies and six technology assessment and transfer contracts were completed in 2014, as listed in Table 5 (page 61). Appendix C comprises two-page summaries of the technical projects completed in 2014. In accordance with California Health and Safety Code Section 40448.5.1(d), this report must be submitted to the state legislature by March 31, 2015, after approval by the SCAQMD Governing Board.

2015 Plan Update

Every year TAO staff re-evaluates the Clean Fuels Program to craft a Plan Update which essentially serves to re-calibrate the compass. The Program continually seeks to support the deployment of lower-emitting technologies. The design and implementation of the Program Plan must balance the needs in the various technology sectors with technology readiness, emissions reduction potential and co-funding opportunity. As the state and federal governments have turned a great deal of their attention to climate change, the SCAQMD has remained committed to developing, demonstrating and commercializing zero and near-zero emission technologies. Fortunately many, if not the majority, of technology sectors that address our need for NO_x reductions also garner greenhouse gas (GHG) reductions. Due to these “co-benefits,” the SCAQMD has been successful in partnering with the state and federal government. To identify project or technology opportunities in which its available funding can make a significant difference in deploying progressively cleaner technologies in the Basin, the SCAQMD employs a number of outreach and networking activities. These range from intimate involvement with state and federal collaboratives, partnerships and industrial coalitions to issuing Program Opportunity Notices to essentially throw out a wide net to solicit project ideas and concepts and Requests for Information to determine the state of various technologies and what is needed to advance those technologies.

As mentioned, the overall strategy is based in large part on technology needs identified in the SCAQMD’s AQMP and the SCAQMD Governing Board’s directives to protect the health of residents in the Basin. The NO_x, VOC and PM emission sources of greatest concern are heavy-duty on-road vehicles, light-duty on-road vehicles and off-road equipment.

The Plan Update includes projects to develop, demonstrate and commercialize a variety of technologies, from near term to long term, that are intended to provide solutions to the emission control needs identified in the 2012 AQMP. While modest NO_x and PM_{2.5} reductions will be needed to meet the federal PM_{2.5} standard in 2015, significant NO_x and PM_{2.5} reductions will be necessary to meet the federal 8-hour ozone standards by 2023 and 2032, in addition to the 1-hour ozone standard of 0.125 ppm by 2022 (which must be met as a result of a 2012 court case even though EPA had previously revoked this standard) and the newly revised federal annual PM_{2.5} standard of 12 µg/m³. Given the need for these significant reductions over the next 10-20 year timeframe, mid- and longer-

term alternative fuels, hybrid, electric and fuel cell based technologies are emphasized. Several of the technology areas of focus include:

- reducing emissions from port-related activities, such as cargo handling equipment and container movement technologies, including demonstration and deployment of zero emission cargo container movement systems;
- mitigating criteria pollutant increases from renewable fuels, such as low-blend ethanol and high-blend biodiesel;
- increased activities in electric, hybrid, battery and plug-in hybrid technologies across light-, medium- and heavy-duty platforms; and
- production of transportation fuels and energy from renewable biowaste sources.

Table 6 lists the potential projects across the core technologies identified in this report. Potential projects for 2015 total more than \$16.4 million, with anticipated leveraging of approximately \$79 million. The proposed projects may also be funded by revenue sources other than the Clean Fuels Program, especially VOC and incentive projects.

CLEAN FUELS PROGRAM

Background & Overview

Program Background

The Basin, which comprises all of Orange County and the urban portions of Los Angeles, San Bernardino and Riverside Counties, has the worst air quality in the nation due to a combination of factors, including high vehicle population, high vehicle miles traveled within the Basin and geographic and atmospheric conditions favorable for photochemical oxidant (smog) formation. Due to these challenges, the state legislature enabled the SCAQMD to implement the Clean Fuels Program to accelerate the implementation and commercialization of clean fuels and advanced technologies in the Basin. In 1999, state legislation was passed which amended and extended the Clean Fuels Program. Specifically, as stated in the California Health and Safety Code (H&SC) section 40448.5.1(d), the SCAQMD must submit to the Legislature, on or before March 31 of each year, an annual report that includes:

1. A description of the core technologies that the SCAQMD considers critical to ensure attainment and maintenance of ambient air quality standards and a description of the efforts made to overcome barriers to commercialization of those technologies;
2. An analysis of the impact of the SCAQMD's Clean Fuels Program on the private sector and on research, development and commercialization efforts by major automotive and energy firms, as determined by the SCAQMD;
3. A description of projects funded by the SCAQMD, including a list of recipients, subcontractors, co-funding sources, matching state or federal funds and expected and actual results of each project advancing and implementing clean fuels technology and improving public health;
4. The title and purpose of all projects undertaken pursuant to the Clean Fuels Program, the names of the contractors and subcontractors involved in each project and the amount of money expended for each project;
5. A summary of the progress made toward the goals of the Clean Fuels Program; and
6. Funding priorities identified for the next year and relevant audit information for previous, current and future years covered by the project.

Furthermore, H&SC section 40448.5.1(a)(2) requires the SCAQMD to find that the proposed program and projects funded as part of the Clean Fuels Program will not duplicate any other past or present program or project funded by the state board and other government and utility entities. This finding does not prohibit funding for programs or projects jointly funded with another public or private agency where there is no duplication. The following section describes the panel of external experts that helps review the Clean Fuels Program.

Program Review

In 1990, the SCAQMD initiated an annual review of its technology advancement program by an external panel of experts. That external review process has evolved, in response to SCAQMD policies and legislative mandates, into two external advisory groups. The Technology Advancement Advisory Group (one of six standing Advisory Groups that make up the SCAQMD Advisory Council) is made up of stakeholders representing industry, academia, regulatory agencies, the scientific community and environmental impacts. The Technology Advancement Advisory Group serves to:

- Coordinate the SCAQMD program with related local, state and national activities;
- Review and assess the overall direction of the program; and
- Identify new project areas and cost-sharing opportunities.

In 1999, the second advisory group was formed as required by SB 98 (Alarcon). Under H&SC Section 40448.5.1(c), this advisory group must comprise 13 members with expertise in clean fuels technology and policy or public health and appointed from the scientific, academic, entrepreneurial, environmental and public health communities. This legislation further specified conflict-of-interest guidelines prohibiting members from advocating expenditures towards projects in which they have professional or economic interests. The objectives of the SB 98 Clean Fuels Advisory Group are to make recommendations regarding projects, plans and reports, including approval of the required annual report prior to submittal to the SCAQMD Governing Board. Also in 1999, in light of the formation of the Clean Fuels Advisory Group, the SCAQMD also revisited the charter and membership of the Technology Advancement Advisory Group to ensure their functions would complement each other.

On an as-needed basis, changes to the composition of the Clean Fuels Advisory Group are reviewed by the SCAQMD Board while changes to the Technology Advancement Advisory Group are reviewed by the SCAQMD Board's Technology Committee. Current membership changes to both advisory groups, if required, will be considered by the SCAQMD Board and its Technology Committee, respectively, as part of consideration of the 2014 Annual Report and 2015 Plan Update. The current members of the SB 98 Clean Fuels Advisory Group and Technology Advancement Advisory Group are listed in Appendix A, with any proposed changes, subject to SCAQMD Board approval, duly noted.

The review process of the Clean Fuels Program now includes at least two full-day retreats of the two Advisory Groups, typically in the summer and winter, review by other technical experts, review by the Technology Committee of the SCAQMD Governing Board, a public hearing of the Annual Report and Plan Update before the full SCAQMD Governing Board, along with adoption of a resolution finding that the proposed program and projects funded as part of the Clean Fuels Program will not duplicate any other past or present program or project funded by the state board and other government and utility entities, as required by the H&SC, and finally submittal of the Annual Report and Plan Update to the Legislature by March 31 of every year.

The Need for Advanced Technologies & Clean Fuels

Achieving federal and state clean air standards in Southern California will require emission reductions from both mobile and stationary sources beyond those expected using current technologies. The need for advanced technologies and clean fuels is best illustrated by Figure 1 below, which identifies NO_x emissions by category and identifies just how far those emissions must be reduced to meet federal standards by 2023 and 2032.

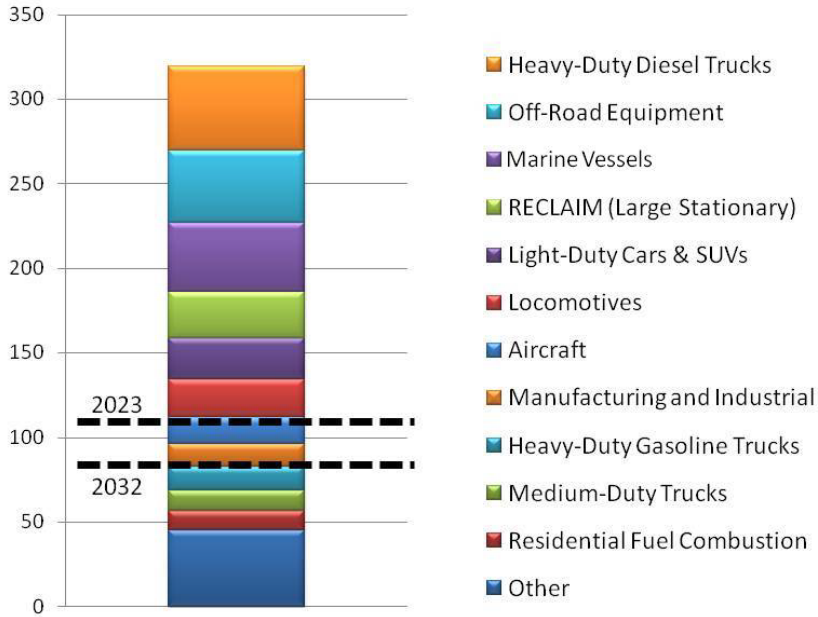

Figure 1: 2023 NO_x Emissions by Category

Additionally, the following piechart reflects NO_x contributors by sector, sharply illustrating the impact of mobile sources on air quality and why the 2012 AQMP calls for the reduction of 200 tons/day of NO_x by 2020 as well as why this region is recognized as an extreme ozone nonattainment area.

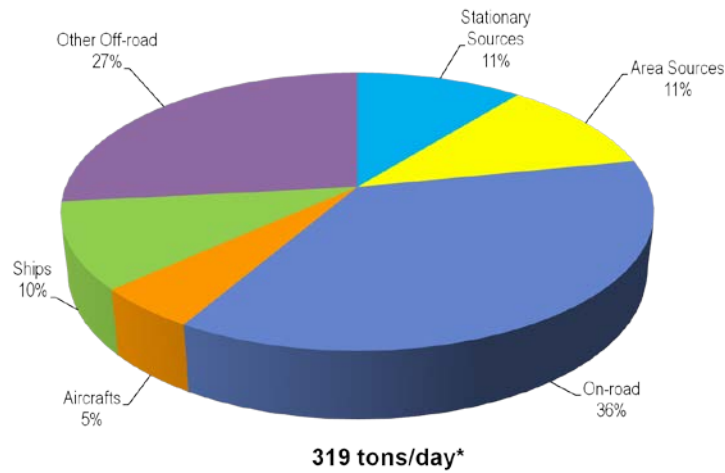

Figure 2: NO_x Contributors by Sector

Finally, the following piechart reflects the relative contribution of PM_{2.5} by source category to the 2023 emission inventory for an average annual day. A supplement to the 24-hour PM_{2.5} SIP will address further PM reductions since preliminary 2014 data appears to suggest that the 24-hour PM_{2.5} standard was not attained in 2014 as anticipated.

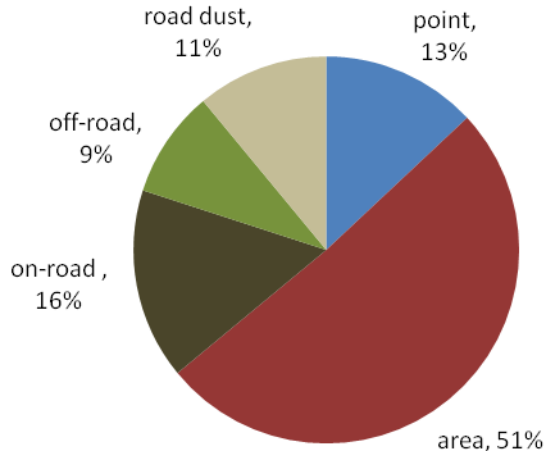

Figure 3: Directly Emitted PM_{2.5} Emissions (71 tons/day)

To fulfill long-term emission reduction targets, the 2012 AQMP relies on a mix of currently available technology as well as the expedited development and demonstration of advanced technologies that are not yet ready for commercial use. Significant reductions are anticipated from implementation of advanced control technologies for both on-road and off-road mobile sources. In addition, the air quality standards for ozone (0.08 ppm, 8-hour average) and fine particulate matter, promulgated by the U.S. Environmental Protection Agency (U.S. EPA) in 1997 and 2006, are projected to require additional long-term control measures for both NO_x and VOC. The 2012 AQMP's estimate of needed NO_x reductions, as well as the 2016 AQMP currently being drafted to meet federal ozone standards, will require the SCAQMD Clean Fuels Program to encourage and accelerate advancement of cleaner, transformative transportation technologies that can be used as control strategies in the AQMP.

Recent health studies also indicate a greater need to reduce NO_x emissions and toxic air contaminant emissions. More importantly, the CARB listed diesel exhaust emissions as a toxic air contaminant in 1998. Subsequently, in 1999, the SCAQMD completed the Multiple Air Toxics Exposure Study (MATES-II) and found that diesel combustion sources (primarily from heavy-duty vehicles) contribute approximately 70 percent to the estimated potential cancer risk from air toxics in the Basin. A follow-on study, MATES-III, in which air quality sampling was initiated in spring 2004 and ended in 2006, was undertaken to evaluate air toxic exposure trends, expand the list of known air toxics and assess local impacts from industrial, commercial and mobile sources. The results showed a decrease in stationary emitted air toxics and gasoline related air toxics, but continued high levels of emissions from diesel engine sources. The MATES-III report was finalized in spring 2008. Although results showed an overall decrease in toxics exposures throughout the basin, there were localized areas that had increased risk, most notably around the Ports of Los Angeles and Long Beach. This increased risk is likely a result of uncontrolled diesel emissions from goods movement activities, specifically emissions from trucks and cargo handling equipment, locomotives and marine vessels. A MATES IV study was launched in 2012. While the goal of MATES IV, like the prior studies, was to assess air toxic levels, update risk characterization, and determine gradients from selected sources, MATES IV added ultrafine PM and black carbon monitoring components as well. A draft report on the findings was released for public review in October 2014. The study found a dramatic decrease in ambient levels of diesel

particulate matter and other air toxics. Diesel PM was still the major driver of air toxics health risks. While the levels and exposures decreased, a revision to the methods used to estimate cancer risk from toxics developed by the California Office of Health Hazard Identification will increase the calculated risk estimates from these exposures by a factor of up to three.

Greenhouse gas (GHG) emissions and petroleum dependency arising from the heavy use of conventional technologies continue to be a concern and focal point for state and federal government as well as the general public. In response to these concerns, the federal government has launched several programs (the Hydrogen, Fuel Cells and Infrastructure Technologies Program and the FreedomCAR and Vehicle Technologies Program) to investigate and develop increased efficiency and alternative fuel (including hydrogen) technologies. Independently, the State has adopted goals to reduce long-term dependence on petroleum-based fuels (AB 2076) and the transition to alternative fuels based on life-cycle analyses (AB 1007).

The 2007 Low Carbon Fuel Standard (LCFS) required producers of petroleum-based fuels to reduce their product's carbon intensity, beginning in 2011 and culminating in a 10 percent total reduction by 2020. However, CARB is currently revising the LCFS regulation and proposed provisions are designed to foster investments in the production of low carbon intensity fuels. Hopefully, this will accelerate research into alternatives to oil and traditional fuels. In September 2008, SB 375 was adopted requiring CARB to set regional targets reducing GHG's from cars and light trucks by 2020 and 2035 and directing regional planning agencies to develop land-use strategies to meet the targets. While the landmark Global Warming Solutions Act of 2006 (AB 32) required California's greenhouse gas emissions to be capped at 1990 levels by 2020, in 2012 California Governor Brown also set a California target for reductions of GHG emissions from the transportation sector of 80 percent less than 1990 levels by 2050 and called for establishment of benchmarks for the penetration of zero emission vehicles and infrastructure for 2015, 2020 and 2025.

In 2012 CARB adopted a LEV III program for Model Year (MY) 2015 to 2025 light- and medium-duty vehicles, amended the Zero Emission Vehicle Regulation and amended the Clean Fuels Outlet requirements. These tighter standards for passenger cars and light- and medium-duty trucks will require reduced tailpipe emissions and nearly no evaporative emissions. CARB also proposed new requirements for zero emission vehicles lowering the threshold requirement, which means automakers must begin producing zero emission vehicles by 2016. To achieve the Governor's Executive Order, CARB envisions that 80 percent of vehicles must be all electric, battery electric, hydrogen and/or fuel cell by 2050. In late 2011 CARB also adopted amendments to low-sulfur marine fuel requirements to extend the nautical zone and loosened cargo handling equipment and transportation refrigeration regulations because sufficient retrofit technologies aren't available in the marketplace. In 2011 the Federal government adopted fuel economy and GHG emissions standards for medium- and heavy-duty vehicles for MYs 2014-2018 and propose to move forward with Tier 3 levels for light- and medium-duty trucks and tighter criteria pollutant standards for passenger vehicles.

In early January 2015 Governor Brown's state-of-the-state address included ambitious goals to help meet California climate targets for 2030 and beyond, including increasing the amount of electricity generated from renewable sources from 33 to 55 percent and reducing the use of petroleum in cars and trucks by up to 50 percent from today's levels.

In summary, advanced, energy efficient and renewable technologies are needed not only for attainment, but also to protect the health of those who reside within the SCAQMD's jurisdiction; to reduce long-term dependence on petroleum-based fuels; and to support a more sustainable

energy future. Conventional strategies and traditional supply and consumption need to be retooled in order to achieve the federal air quality goals. To help meet this need for advanced, clean technologies, the SCAQMD Governing Board continues to aggressively carry out the Clean Fuels Program and promote alternative fuels through its Technology Advancement Office (TAO).

The Clean Fuels Program is intended to assist in the rapid development and deployment of progressively lower-emitting technologies and fuels through innovative public-private partnership. Since its inception, SCAQMD's TAO has co-funded projects in cooperative partnerships with private industry, technology developers, academic and research institutions and local, state and federal agencies. The following sections describe program funding, provide a 2014 overview and describe core technologies of the Clean Fuels Program.

Program Funding

The Clean Fuels Program is established under California H&SC Sections 40448.5 and 40512 and Vehicle Code Section 9250.11. This legislation establishes mechanisms to collect revenues from mobile and stationary sources to support the program objectives and identifies the constraints on the use of funds. In 2008, these funding mechanisms were reauthorized under SB 1646 (Padilla), which removed the funding sunset of January 1, 2010, and established the five percent administrative cap instead of the previous cap of two-and-half percent.

The Program is funded through a \$1 fee on motor vehicles registered in the SCAQMD. Revenues collected from these motor vehicles must be used to support mobile source projects. Stationary source projects are funded by an emission fee surcharge on stationary sources emitting more than 250 tons of pollutants per year within the SCAQMD. For CY 2014 the funds available through each of these mechanisms were as follows:

- | | |
|---|--------------|
| • Mobile sources (DMV revenues) | \$12,742,599 |
| • Stationary sources (emission fee surcharge) | \$345,016 |

The SCAQMD Clean Fuels Program also receives grants and cost-sharing revenue contracts from various agencies, on a project-specific basis, that supplement the SCAQMD program. Historically, such cooperative project funding revenues have been received from CARB, the CEC, the U.S. EPA, the U.S. Department of Energy (DOE) and the U.S. Department of Transportation (DOT). These supplemental revenues depend in large part on the originating agency, its budgetary and planning cycle and the specific project or intended use of the revenues. Table 3 (page 31) lists supplemental grants and revenues totaling nearly \$6 million for contracts executed in CY 2014. Table 4 (page 32) lists federal and state revenue totaling nearly \$20 million awarded to the SCAQMD in 2014 for projects that will be part of the Clean Fuels Program or align well and will complement the Clean Fuels Program.

The final and perhaps most significant funding source can best be described as an indirect source, i.e., funding not directly received by the SCAQMD. This indirect source is the cost-sharing provided by private industry and other public and private organizations. Historically, the Technology Advancement Office has been successful in leveraging its available public funds with \$3 to \$4 of outside funding for each \$1 of SCAQMD funding. For 2014, the Clean Fuels Program leveraged each \$1 to approximately \$5 of outside funding. Through these public-private partnership, the SCAQMD has shared the investment risk of developing new technologies along with the benefits of expedited development and commercial availability, increased end-user acceptance, reduced emissions from the demonstration projects and ultimately increased use of clean technologies in the Basin. The SCAQMD's Clean Fuels Program has also avoided

duplicative efforts by coordinating and jointly funding projects with major funding agencies and organizations. The major funding partners for 2014 are listed in Table 1 (page 16).

2014 Overview

This report summarizes the progress of the SCAQMD Clean Fuels Program for CY 2014. The SCAQMD Clean Fuels Program co-sponsors projects to develop and demonstrate zero, near-zero and low emission clean fuels and advanced technologies and to promote commercialization and deployment of promising or proven technologies in Southern California. These projects are conducted through public-private partnerships with industry, technology developers, academic and research institutes and local, state and federal agencies.

This report also highlights achievements and summarizes project costs of the SCAQMD Clean Fuels Program in this period. During the period between January 1 and December 31, 2014, the SCAQMD executed 65 new contracts, projects or studies and modified 7 continuing projects adding additional dollars during CY 2014 that support clean fuels and advanced zero, near-zero and low emission technologies. The SCAQMD Clean Fuels Program contribution for these projects was approximately \$14.3 million, inclusive of nearly \$6 million received into the Clean Fuels Program as cost-share for contracts executed in this reporting period, with total project costs of nearly \$64.7 million. These projects address a wide range of issues with a diverse technology mix. The report not only provides information on outside funding received into the Clean Fuels Fund as cost-share for contracts executed in this period (summarized in Table 3), but also funds awarded to the SCAQMD for projects to be included in the Clean Fuels Program or which align well and are complementary to the Clean Fuels Program (\$20 million in 2014). More details on this financial summary can be found later in this report. The SCAQMD will continue to pursue federal and state funding opportunities in 2015 to amplify leverage, while acknowledging that support of a promising technology is not contingent on outside cost-sharing.

Core Technologies

Given the diversity of sources that contribute to the air quality problems in the Basin, there is no single technology or “Silver Bullet” that can solve all of the problems. A number of technologies are required and these technologies represent a wide range of applications, with full emissions benefit “payoffs,” i.e., full commercialization and mass deployment occurring at different times. The broad technology areas of focus – the “Core Technologies” – for the Clean Fuels Program are as follows:

- Electric and Hybrid Vehicle Technologies and Infrastructure (emphasizing electric and hybrid electric trucks and zero emission container transport technologies)
- Engine Systems (particularly heavy-duty natural gas engines for truck and rail applications)
- Infrastructure and Deployment (predominantly compressed and liquid natural gas)
- Hydrogen and Fuel Cell Technologies and Infrastructure
- Emissions, Fuels and Health Impacts Studies
- Stationary Clean Fuels Technologies
- Emission Control Technologies
- Outreach and Technology Transfer

The SCAQMD continually seeks to support the deployment of lower-emitting technologies. The Clean Fuels Program is shaped by two basic factors:

1. Low, near-zero and zero emission technologies needed to achieve clean air standards in the Basin; and
2. Available funding to support technology development within the constraints imposed by that funding.

The SCAQMD strives to maintain a flexible program to address dynamically evolving technologies and the latest progress in the state of the technology while balancing the needs in the various technology sectors with technology readiness, emissions reduction potential and co-funding opportunity. Although the SCAQMD program is significant, national and international activities affect the direction of technology trends. As a result, the SCAQMD program must be flexible in order to leverage and accommodate these changes in state, national and international priorities. Nonetheless, while the state and federal governments have turned a great deal of their attention to climate change, the SCAQMD has remained committed to developing, demonstrating and commercializing zero and near-zero emission technologies. Fortunately many, if not the majority, of technology sectors that address our need for NO_x reductions also garner greenhouse gas (GHG) reductions. Due to these “co-benefits,” the SCAQMD has been successful in partnering with the state and federal government. The ultimate challenge for the SCAQMD is to identify project or technology opportunities in which its available funding can make a difference in achieving progressively cleaner air in the Basin. To do this, the SCAQMD employs a number of outreach and networking activities. These range from intimate involvement with state and federal collaboratives, partnerships and industrial coalitions to issuing Program Opportunity Notices to essentially throw out a wide net to solicit project ideas and concepts and Requests for Information to determine the state of various technologies and what is needed to advance those technologies. While employing a number of creative outreach and networking activities to try to overcome these challenges, SCAQMD’s Technology Advancement Office annually develops a comprehensive plan to encourage and accelerate the development and demonstration of cleaner technologies. Every year TAO staff re-evaluates the Clean Fuels Program to craft a comprehensive plan (referred to as the 2015 Plan Update within this document) essentially recalibrating the compass for the Clean Fuels Program for the upcoming year.

Historically, mobile source projects have targeted low emission developments in automobiles, transit buses, medium- and heavy-duty trucks and non-road applications. These vehicle-related efforts have focused on advancements in engine design, electric power-trains and energy storage/conversion devices (e.g., fuel cells and batteries); and implementation of clean fuels (e.g., natural gas, propane and hydrogen) including their infrastructure development. Stationary source projects have included a wide array of advanced low NO_x technologies and clean energy alternatives such as fuel cells, solar power and other renewable energy systems. The focus on recent years has been on zero and near-zero emission technologies to reduce emissions from mobile sources, which contribute to more than three-fourths of the NO_x emissions in this region. And while mobile sources include both on- and off-road vehicles as well as aircraft and ships, only the federal government has the authority to regulate emissions from aircraft and ships. As previously mentioned, however, in 2011, CARB adopted amendments to low-sulfur marine fuel requirements to extend the nautical zone out from the ports.

Specific projects are selected for co-funding from competitive solicitations, cooperative agency agreements and unsolicited proposals. Criteria considered in project selection include emissions reduction potential, technological innovation, potential to reduce costs and improve cost effectiveness, contractor experience and capabilities, overall environmental impact or benefit, commercialization and business development potential, cost sharing and consistency with program goals and funding constraints. The core technologies for the SCAQMD programs that

meet both the funding constraints as well as 2012 AQMP needs for achieving clean air are briefly described below.

Electric and Hybrid Vehicle Technologies and Infrastructure

There has been an increased level of activity and attention on electric and hybrid vehicles due to a confluence of factors, including the highly successful commercial introductions of hybrid passenger vehicles and more recently electric vehicles by almost all of the automakers, volatility in oil prices and increased public attention on global warming. In January 2012, CARB adopted the California Zero Emission Vehicle (ZEV) III requirements and amended the ZEV and Clean Fuels Outlet (CFO) regulations. There are alternative strategies allowed to comply with the ZEV regulation, including producing battery electric vehicles, plug-in hybrid electric vehicles (PHEVs), and hydrogen-fueled internal combustion engine (ICE) vehicles.

As a result, there is now a window of opportunity to leverage state and federal activities in the development and deployment of technologies that can accelerate advanced electric and hybrid technologies, including PHEV, medium- and heavy-duty hybrid vehicle deployment, energy storage technologies, development of medium- and heavy-duty hybrid emission certification cycles, battery durability testing and establishment of driver use patterns. Such technology developments, if successful, are considered *enabling* because they can be applied to a variety of fuels (e.g., gasoline, natural gas, ethanol and hydrogen) and propulsion systems (e.g., ICEs and fuel cells). Electric and hybrid technologies are also being explored to address one of the SCAQMD's 2014-15 Goals and Priority Objectives, which is to continue demonstration and deployment of projects achieving zero tailpipe emissions for container transport.

Engine Systems

Medium- and heavy-duty on-road vehicles contributed approximately 36 percent of the Basin's NO_x based on 2007 AQMP data. More importantly, on-road heavy-duty diesel engines contributed almost 60 percent of the on-road mobile source PM_{2.5}, which has known toxic effects. These figures notably do not include the significant contribution from off-road mobile sources. In fact, CARB's off-road 2006 emission model estimates that diesel-powered off-road construction equipment alone emits 120 tons per day of NO_x and 7.5 tons per day of PM emissions in the Basin. Furthermore, while MATES IV found a dramatic decrease in ambient levels of diesel PM and other air toxics, diesel PM is still the major driver of air toxics health risks. Clearly, significant emission reductions will be required from mobile sources, especially from the heavy-duty sector, to attain the federal clean air standards.

The use of alternative fuels in heavy-duty vehicles can provide significant reductions in NO_x and particulate emissions. The current NO_x emissions standard for heavy-duty engines is 0.2 g/bhp-hr. The SCAQMD, along with various local, state and federal agencies, continues to support the development and demonstration of alternative fueled low-emission heavy-duty engine technologies, using compressed natural gas (CNG) and liquefied natural gas (LNG), for applications in heavy-duty transport trucks, transit and school buses, rail operations, and refuse collection and delivery vehicles to meet future federal emission standards.

Infrastructure and Deployment (NG)

A key element for the widespread acceptance and resulting increased use of alternative fueled vehicles is the availability of the supporting refueling infrastructure. The refueling infrastructure for gasoline and diesel fuel is well established and accepted by the driving public. Alternative,

clean fuels such as alcohol-based fuels, propane, hydrogen, hydrogen-natural gas mixtures and even electricity are much less available or accessible, whereas natural gas has recently become more readily available in light of fracking technologies being employed to access the abundant shale gas deposits throughout North America. Having said that, there is a concern that falling oil prices may cause a resurgence in diesel fuel desirability and movement away from natural gas use. Nonetheless, to realize emissions reduction benefits, alternative fuel infrastructure must be developed in tandem with the growth in alternative fueled vehicles. The objectives of the SCAQMD are to expand the infrastructure to support zero and near-zero emission vehicles through the development, demonstration and installation of alternative fuel vehicle refueling technologies. However, this category is predominantly targeted at compressed and liquid natural gas infrastructure and deployment, with the related infrastructure for electric and hybrid and hydrogen and fuel cell included within their technology category.

Hydrogen and Fuel Cell Technologies and Infrastructure

Most of the automobile manufacturers have conceded that mass commercial introduction of fuel cell vehicles (FCVs) are likely to be delayed due to the cost, durability and infrastructure issues associated with hydrogen fueling. A survey of the major automakers conducted by the California Fuel Cell Partnership (CaFCP) estimates that there will be approximately 53,000 fuel cell vehicles by 2017, if sufficient hydrogen infrastructure is available. The SCAQMD continues to support the infrastructure required to refuel these demonstration fuel cell vehicles, but is also actively engaged in finding alternatives to the costly and potential longer term fuel cell power plant technology. As mentioned previously, plug-in hybrid technology could help enable fuel cells by reducing the capacity, complexity and cost of the fuel cell vehicle system. Further bridging technologies being investigated are hybrid or plug-in hybrid hydrogen ICE vehicles and hydrogen-CNG blended ICE vehicles.

Emissions, Fuels and Health Impacts Studies

The monitoring of pollutants in the Basin is extremely important, especially when focused on (1) a particular sector of the emissions inventory (to identify the responsible technology) or (2) exposure to pollution (to assess the potential health risks). Recent studies indicate that smoggy areas can produce irreversible damage to children's lungs. This information highlights the need for further emissions and health studies to identify the emissions from high polluting sectors as well as the health effects resulting from these technologies.

Over the past few years, the SCAQMD has funded emission studies to evaluate the impact of tailpipe emissions of biodiesel and ethanol fueled vehicles mainly focusing on criteria pollutants and greenhouse gas (GHG) emissions. These studies showed that biofuels, especially biodiesel, can contribute to higher NO_x emissions while reducing other criteria pollutant emissions. Furthermore, despite recent advancements in toxicological research related to air pollution, the relationship between particle chemical composition and health effects is still not completely understood, especially for biofuels. Therefore, a couple of years ago the SCAQMD funded studies to investigate the physical and chemical composition and toxicological potential of tailpipe PM emissions from biodiesel and ethanol fueled vehicles to better understand their impact on public health. Studies continued in 2014 to further investigate the toxicological potential of emissions, such as ultrafine particles and vapor phase substances, and to determine whether or not other substances such as volatile or semi-volatile organic compounds are being emitted in lower mass emissions that could pose harmful health effects.

Stationary Clean Fuel Technologies

Given the limited funding available to support low emission stationary source technology development, this area has historically been limited in scope. To gain the maximum air quality benefits in this category, higher polluting fossil fuel-fired electric power generation needs to be replaced with clean renewable energy resources or other advanced near zero-emission technologies, such as solar, wind, geo-thermal energy, bio-mass conversion and stationary fuel cells. Although combustion sources are lumped together as stationary, the design and operating principles vary significantly and thus also the methods and technologies for control of their emissions. Included in the stationary category are boilers, heaters, gas turbines and reciprocating engines. Boilers and heaters vary in size, heat input, process conditions and operating ranges. Gas turbines vary greatly in size and application and are typically natural gas-fired with add-on controls to clean up the flue gas. Stationary ICEs can be either rich-burn or lean-burn. The core technologies for this category focus on using advanced combustion processes, development of catalytic add-on controls, alternative fuels and technologies and stationary fuel cells in novel applications.

Emission Control Technologies

This broad category refers to technologies that could be deployed on existing mobile sources, aircraft, locomotives, marine vessels, farm and construction equipment, cargo handling equipment, industrial equipment, and utility and lawn-and-garden equipment. The in-use fleet comprises the majority of emissions, especially the older vehicles and non-road sources, which are typically uncontrolled and unregulated, or controlled to a much lesser extent than on-road vehicles. The authority to develop and implement regulations for retrofit on-road and non-road mobile sources lies primarily with the U.S. EPA and CARB and to a lesser extent with the SCAQMD.

Low emission and clean-fuel technologies that appear promising for on-road mobile sources should be effective at reducing emissions from a number of non-road sources. For example, immediate benefits are possible from particulate traps, selective catalytic reduction (SCR) and emulsified fuels that have been developed from diesel applications. Clean fuels such as natural gas, propane, hydrogen and hydrogen-natural gas mixtures may also provide an effective option to reduce emissions from some non-road applications. Reformulated gasoline, ethanol and alternative diesel fuels, such as biodiesel and gas-to-liquid (GTL), also show promise when used in conjunction with advanced emissions controls and new engine technologies. The CARB, U.S. EPA and the SCAQMD have also promulgated regulations that lower the sulfur content of diesel fuels, which provides a direct fuel related PM reduction and improves the efficiency of particulate reduction aftertreatment devices.

Outreach and Technology Transfer

Since the value of the Clean Fuels Program depends on the deployment and adoption of the demonstrated technologies, outreach and technology transfer efforts are essential to its success. This core area encompasses assessment of advanced technologies, including retaining outside technical assistance as needed, efforts to expedite the implementation of low emission and clean fuels technologies, coordination of these activities with other organizations and information dissemination to educate the end user. Technology transfer efforts include support for various clean fuel vehicle incentive programs as well.

CLEAN FUELS PROGRAM

Barriers, Scope and Impact

Overcoming Barriers

Commercialization and implementation of advanced technologies come with a variety of challenges and barriers. A combination of real-world demonstrations, education, outreach and regulatory impetus and incentives is necessary to catalyze new, clean technologies. To reap the maximum emissions benefits from any technology, widespread deployment and thus end-user acceptance must occur. The product manufacturers must overcome technical and market barriers to ensure a competitive and sustainable business. Barriers include project-specific issues as well as general technology concerns.

Technology Implementation Barriers

- Viable commercialization path
- Technology price/performance parity with conventional technology
- Consumer acceptance
- Fuel availability/convenience issues
- Certification, safety and regulatory barriers
- Quantifying emissions benefits
- Sustainability of market and technology

Project-Specific Issues

- Identifying a committed demonstration site
- Overall project cost and cost-share using public monies
- Securing the fuel
- Identifying and resolving real & perceived safety issues
- Quantifying the actual emissions benefits
- Viability of the technology provider

Other barriers include reduced or shrinking research budgets, infrastructure and energy uncertainties and risks, sensitivity to multi-media environmental impacts and the need to find balance between environmental needs and economic constraints. The SCAQMD seeks to address these barriers by establishing relationships through unique public-private partnerships with key stakeholders; e.g., industry, end-users and other government agencies with a stake in developing clean technologies. Partnerships that involve all the key stakeholders have become essential to address these challenges in bringing advanced technologies from development to commercialization.

Each of these stakeholders and partners contributes more than just funding. Industry, for example, can contribute technology production expertise as well as the experience required for compatibility with process operations. Academic and research institutes bring state-of-the-technology knowledge and testing proficiency. Governmental and regulatory agencies can provide guidance in identifying sources with the greatest potential for emissions reduction, assistance in permitting and compliance issues, coordinating of infrastructure needs and facilitation of standards setting and educational outreach. Often, there is considerable synergy in developing technologies that address multiple goals of public and private bodies regarding the environment, energy and transportation.

Scope and Benefits of the Clean Fuels Program

Since the time needed to overcome barriers can be long and the costs high, both manufacturers and end-users tend to be discouraged from considering advanced technologies. The Clean Fuels Program addresses these needs by co-funding research, development, demonstration and deployment projects to share the risk of emerging technologies with their developers and eventual users.

Figure 4 provides a conceptual design of the wide scope of the Clean Fuels Program. As mentioned in the Core Technologies section, various stages of technology projects are funded not only to provide a portfolio of emissions technology choices but to achieve emission reduction benefits in the nearer as well as over the longer term.

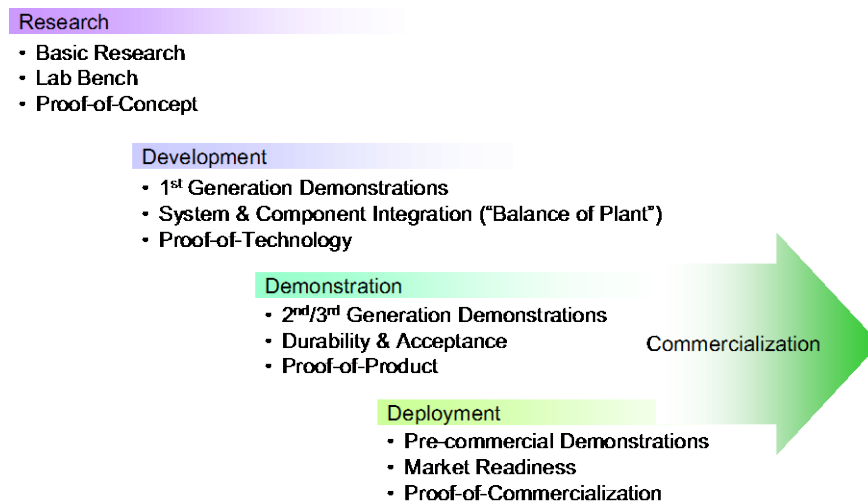

Figure 4: Stages of Clean Fuels Program Projects

Due to the nature of these advanced technology research, development, demonstration and deployment projects, the benefits are difficult to quantify since their full emission reduction potential may not be realized until sometime in the future, or perhaps not at all if displaced by superior technologies. Nevertheless, a good indication of the impact and benefits of the Clean Fuels Program overall is provided by this selective list of sponsored projects that have resulted in commercialized products or helped to advance the state-of-the-technology.

- CNG Engine Development for Heavy-Duty Vehicles
 - Emission Solutions: 7.6L (NG)
 - Cummins Westport: C8.3L (CNG, LNG), B5.9L (CNG) L10 (CNG), ISL G 8.9L (CNG, LNG)
 - Westport Power: ISX 15L (LNG), Westport GX 15 L (dual fuel)
 - Detroit Diesel: Series 60G (CNG/LNG), Series 50G (CNG/LNG);
 - John Deere: 6068 (CNG), 6081 (CNG);
 - Mack: E7-400G (LNG); and
 - Clean Air Partners/Power Systems (Caterpillar): 3126B (Dual Fuel), C-10 (Dual Fuel), C-12 (Dual Fuel).
- Fuel Cell Development and Demonstrations
 - Ballard Fuel Cell Bus (first of its kind);
 - ISE/ThunderPower Fuel Cell Bus;
 - Sunline Transit Agency Advanced Fuel Cell Bus projects;

- Commercial Stationary Fuel Cell Demonstration with UTC and SoCalGas (first of its kind); and
 - Orange County Sanitation District hydrogen and combined heat and power generation from biogas using molten carbonate fuel cell technology.
- Electric and Hybrid Electric Vehicle Development and Demonstrations
- EPRI hybrid vehicle evaluation study;
 - Hybrid electric vehicle demonstrations with SCE, UC Davis and AC Propulsion;
 - Plug-in Hybrid Electric Van with EPRI, DaimlerChrysler and SCE;
 - Hybrid electric delivery trucks with Azure Dynamics, NREL and FedEx;
 - Plug-in hybrid work truck with Odyne Systems;
 - Proterra battery electric transit bus and fast charging system;
 - Municipal battery electric utility truck;
 - South Bay City Council of Governments' electric vehicle project;
 - EVI/UPS electric truck; and
 - TransPower battery electric heavy-duty truck
- Aftertreatment Technologies for Heavy-Duty Vehicles
- Johnson Matthey and Engelhard trap demonstrations on buses and construction equipment; and
 - Johnson Matthey SCRT and SCCRT NO_x and PM reduction control devices on heavy-duty on-road trucks.

SCAQMD played a leading or major role in the development of these technologies, but their benefits could not have been achieved without all stakeholders (i.e., manufacturer, end-users and government) working collectively to overcome the technology, market and project-specific barriers encountered at every stage of the research, development, demonstration and deployment process.

Strategy and Impact

In addition to the feedback and input detailed in Program Review (pages 1-2), the SCAQMD actively seeks additional partners for its program through participation in various working groups, committees and task forces. This participation has resulted in coordination of the SCAQMD program with a number of state and federal government organizations, including CARB, CEC, U.S. EPA and U.S. DOE and several of its national laboratories. Coordination also includes the AB 2766 Discretionary Fund Program administered by the Mobile Source Air Pollution Reduction Review Committee (MSRC), various local air districts, National Association of Fleet Administrators (NAFA), major local transit districts and local gas and electric utilities. The list of organizations with which the SCAQMD coordinates research and development activities also includes organizations specified in H&SC Section 40448.5.1(a)(2).

In addition, the SCAQMD holds periodic meetings with several organizations specifically to review and coordinate program and project plans. For example, the SCAQMD staff meets with CARB staff to review research and development plans, discuss project areas of mutual interest, avoid duplicative efforts and identify potential opportunities for cost-sharing. Periodic meetings are also held with industry-oriented research and development organizations, such as the California Fuel Cell Partnership (CaFCP), the California Stationary Fuel Cell Collaborative, the California Natural Gas Vehicle Partnership (CNGVP), the California Plug-In Electric Vehicle (PEV) Collaborative, the Electric Power Research Institute (EPRI), the West Coast Collaborative, which is part of the National Clean Diesel Campaign, and the Manufacturers of Emission

Controls Association (MECA). The coordination efforts with these various stakeholders have resulted in a number of cosponsored projects.

Descriptions of some of the key contracts executed in CY 2014 are provided in the next section of this report. It is noteworthy that most of the projects are cosponsored by various funding organizations and include the active involvement of original equipment manufacturers. Such partnerships are essential to address commercialization barriers and to help expedite the implementation of advanced low emission technologies. Table 1 below lists the major funding agency partners and manufacturers actively involved in SCAQMD projects for this reporting period. It is important to note that, although not listed, there are many other technology developers, small manufacturers and project participants who make important contributions critical to the success of the SCAQMD program. These partners are identified in the more detailed 2014 Project Summaries (beginning page 28) contained within this report.

Table 1: SCAQMD Major Funding Partners in CY 2014

Research Funding Organizations	Major Manufacturers/Providers
California Air Resources Board	Ports of Los Angeles & Long Beach
California Energy Commission	Southern California Gas Company
National Renewable Energy Laboratory	University of California Riverside/ CE-CERT
U.S. Department of Energy	Other California Universities (Davis, Irvine, LA)
U.S. Environmental Protection Agency	Siemens Industry Inc.
	Transportation Power Inc.

The following two subsections broadly address the SCAQMD’s impact and benefits by describing specific examples of accomplishments and commercial—or near-commercial—products supported by the Clean Fuels Program in CY 2014. Such examples are provided in the following sections on the Technology Advancement Office’s Research, Development and Demonstration projects and Technology Deployment and Commercialization efforts.

Research, Development and Demonstration

Important examples of the impact of the SCAQMD research and development coordination efforts include: (a) development and demonstration of a catenary zero emissions goods movement system in conjunction with development and demonstration of diesel catenary hybrid electric trucks; (b) development of Class 8 zero emission electric trucks; (c) development of a plug-in hybrid electric retrofit system for Class 6-8 trucks; (b) development, integration and demonstration of ultra-low emission natural gas engines for heavy-duty vehicle applications; and (e) a health study to develop quantitative cellular assays for use in understanding the chemical basis of air pollutant toxicity.

Develop and Demonstrate Catenary Zero Emissions Goods Movement System

The SCAQMD has identified the development and deployment of zero-emissions goods movement transportation systems as one of the agency’s top priorities in order to attain federal air quality standards. Zero-emission transportation and goods movement technologies are also being proposed in SCAG’s 2012 Goods Movement Appendix to the Regional Transportation Plan as

well as the joint CARB, SCAQMD and SJVAPCD “Vision for Clean Air: A Framework for Air Quality and Climate Planning”. Zero-emission truck lanes are also being considered for the I-710 freeway expansion, which is an approximately 20 mile north-south trade corridor.

The primary goal of this project is to promote the implementation of zero-emission goods movement technologies, and the secondary goal is to demonstrate the most viable technology to be adopted for a future, regional zero-emissions corridor. Although this project is for a one-mile demonstration, the potential next phase is to build out the remaining route from the ports to the near-dock rail yard which is approximately 5 miles. Subsequent phases would be to initiate the design and build the same or similar technology for the I-710 expansion and an east-west trade corridor for containers going to the Inland Empire warehouses.

Siemens Industry Inc. (Siemens) has designed and demonstrated a catenary truck technology, eHighway, in Germany on a European truck chassis. For this project, Siemens proposes to bring the eHighway technology to southern California with their partner Volvo and to develop and demonstrate a catenary plug-in hybrid electric truck technology. The hybrid drive system will extend the operating range of the truck beyond the all-electric range of the catenary system, enabling the truck to perform regional drayage operations and bridge gaps in catenary infrastructure as it is deployed on a regional level. Siemens and Volvo propose to develop and integrate a Mack Granite Vision diesel hybrid electric class 8 truck configured to operate on the catenary system. The vehicle will use Volvo’s current hybrid 150 kW electro-mobility propulsion system, upgraded with a pantograph to operate on the eHighway system. The Siemens’ pantograph system will allow for seamless connection and detachment from the catenary power source. When entering the catenary system corridor, the pantograph system will verify the



Figure 5: Catenary-Accessible Trucks on the Siemens' Test Track in Berlin, Germany

presence of catenary lines and allow the driver to raise the pantograph from within the cab of the truck. Upon leaving the catenary lane, the pantograph will automatically retract and the truck will switch to on-board power systems. The on-board power systems could be a range of technologies, including batteries, fuel cells or internal combustion engines.

There will be a total of four trucks operating on the catenary system. There will be the one from Volvo mentioned above plus three more from other projects initiated by SCAQMD. TransPower, a local integrator, will develop two trucks--a CNG hybrid and battery electric truck, and Kenworth, with its partner BAE Systems, will develop and test a CNG hybrid.

Develop and Demonstrate Additional Class 8 Zero Emission Battery Electric Trucks

Heavy-duty diesel trucks in the South Coast Air Basin remain a significant source of emissions with adverse health effects, especially in the surrounding communities along the goods movement corridors near the Ports of Los Angeles and Long Beach and next to major freeways. In order to mitigate the impact and attain stringent federal ozone standards, SCAQMD has been aggressively promoting and supporting the development and deployment of advanced zero-emission cargo transport technologies, including battery electric trucks.

In October 2012, Transportation Power Inc. (TransPower) was awarded \$1.14 million, as part of a DOE grant, to develop and demonstrate four Class 8 zero emission battery electric drayage trucks

in real world operations, transporting cargo containers from the Ports of Los Angeles and Long Beach to local warehouses and intermodal facilities. Subsequent to the award, TransPower received additional funding from CEC and the San Pedro Bay Ports' Technology Advancement Program to develop three more electric drayage trucks to demonstrate a total of seven trucks. This project is to cost-share the development and demonstration of the three additional trucks and also to fund related engineering design upgrades. These upgrades are based on lessons learned from the manufacture and operation of a prototype electric truck, which was also previously cost shared by the SCAQMD. TransPower anticipates the upgrades will collectively increase the operating efficiency and reduce vehicle assembly costs by approximately 25 percent, significantly improving the commercial value of the drive system.

Some of the key advances to be developed and incorporated in this project include the following:

- Automated manual transmission – a development of proprietary software to precisely match powertrain gearing to vehicle torque requirements, improving performance and operating efficiency. It will also achieve significant cost savings through the use of a lower-cost off-the-shelf



Figure 6: TransPower Electric Drayage Truck

- manual transmission.
- Advanced energy storage subsystem – a major redesign of the battery pack to simplify the assembly and servicing of the trucks with a larger and more rugged battery enclosures, requiring much less wiring and connectors. A new battery management system (BMS) will be also developed to communicate more reliably and balance cells faster and more efficiently than competing BMS boards, improving the operating range and battery life.
- Power control and accessory subsystem – an innovative concept to pre-integrate most vehicle controllers and electrically driven accessories on a module before vehicle installation. Previously, these components were mounted directly onto the vehicle in various locations, requiring complex wiring and hundreds of hours for installation. This new pre-integration approach will not only be easier and safer but will also reduce significant time and costs in assembly and servicing of production vehicles.
- TransPower will partner with Total Transportation Services, Inc., a licensed motor carrier operating at the Ports of Los Angeles and Long Beach and other fleet operators, to demonstrate these trucks in revenue drayage service for two years or more to evaluate their performance and reliability.

Develop and Demonstrate Plug-In Hybrid Electric Retrofit System for Class 6 to 8 Trucks

The objectives of this project are to develop and design a retrofit plug-in hybrid electric system for work truck applications, such as bucket trucks, digger derricks, and underground utility trucks. During the two-year period of the project, the Odyne Systems will develop and evaluate concept designs, produce a selected concept, and evaluate one plug-in hybrid-electric medium-

and heavy-duty work truck with extended stationary engine-off technology. The one vehicle will be deployed in the South Coast Air Basin. The primary objectives of this project are:

- To improve specific aspects of the existing system through the use of smaller, lower cost components.
- To optimize the system and selected powertrain components for high volume production to enhance commercial appeal through lower-cost products and components.
- To match the size of the power electronics and energy storage device to customer duty cycle and work practice.

To quantify improvements in fuel economy and emissions the project will gather vehicle and component performance data during deployment that will enable the operating cost and environmental impact of the vehicle to be assessed. The Odyne hybrid retrofit solution will



Figure 7: Class 7 Bucket Truck Equipped with Odyne Plug-In Hybrid Drive System

provide fleets an option in the SCAQMD to address the emissions that are being created from existing diesel vehicles within the fleet. This option will provide an immediate impact on the emissions being created and will not require the fleets to turn over the entire fleet to have a significant impact on emissions. On new vehicles the fleets can continue to purchase vehicles with the Odyne plug-in hybrid solution and retire the oldest, highest emission producing vehicles in the fleet. The Odyne retrofit solution will also provide an economical solution to address the existing vehicles within the South Coast Air Quality District. With retrofit vehicles having a shorter life before they are retired, the retrofit solution needs to

provide a payback within three to five years. With fuel and maintenance savings of \$5,000 to \$8,000 per year and a targeted sell price of less than \$30,000.00, the Odyne retrofit solution should provide those benefits for many applications.

Develop, Integrate and Demonstrate Ultra-Low Emission Natural Gas Engines from On-Road Heavy-Duty Engines

Heavy-duty on-road diesel vehicles are currently one of the largest sources of NO_x emissions in the South Coast Air Basin. This source category is still projected to be one of the largest contributors to NO_x emissions, even as the legacy fleet of older and higher polluting vehicles are retired from operation and replaced by the vehicles meeting the most stringent emission levels required by 2010 emissions standards. The 2012 AQMP showed that NO_x reductions in excess of 60% will be needed from all source categories to meet future federal ambient air quality standards for ozone. The development of ultra-low emission natural gas engines would significantly reduce emissions from this source category and assist the region in meeting federal ambient air quality standards in the future.

SCAQMD worked closely with the California Energy Commission, Southern California Gas Company and the U.S. Department of Energy to craft a Request for Proposals to solicit proposals for the development of an ultra-low NO_x emissions engine. CARB also adopted optional

emission standards of 0.02 g/bhp-hr to enable incentive funding which improves market opportunity.

Cummins, Inc. proposed to develop, integrate and demonstrate in typical operations a 15L natural gas engine meeting the optional standard of 0.02 g/bhp-hr NO_x, which is 90% lower than current 2010 emission standards, 0.01 g/bhp-hr PM, 0.14 g/bhp-hr NMHC, and 15.5 g/bhp-hr CO with a maximum average of 10 ppm ammonia during the U.S EPA Heavy-Duty Engine Federal Test Procedure (HD-FTP).

NO_x emissions 90% lower than current production engines will require improved and



Figure 9: Heavy-Duty NG Engine



Figure 8: Typical Heavy-Duty Drayage Truck

more uniform combustion cycle to cycle within each cylinder and from cylinder to cylinder as well as improved low temperature NO_x control during engine startup and engine idling periods. As a result, the project provides for extensive theoretical engine and after treatment computer modeling, component bench testing, and prototype engine tests during the first year. A design review after the first year determines whether the project should continue to development of a pre-production engine for optimizing calibrations and emission certification tests.

Upon successful HD-FTP tests, two production-intent engines will be integrated into commercial trucks for a six month field demonstration in typical service including chassis dynamometer tests. The goal of this project is to achieve a production-intent ultra-low NO_x emission natural gas heavy-duty engine that could enter the market by 2020. The target vehicle applications include Class 8 refuse, goods movement and drayage trucks.

Develop Quantitative Cellular Assays for Use in Understanding the Chemical Basis of Air Pollutant Toxicity

The objective of this research is to develop a biological mechanism-based analytical procedure to characterize the toxicity air pollutants. The study is developing and characterizing a standard in quantities sufficient to be employed in subsequent toxicity analyses of vehicle emissions and ambient pollutants. The project aims to collect a large quantity of diesel exhaust, including both particulate and vapor phase, from a well-characterized engine using low-sulfur fuel as the standard. Quantitative dose response toxicity assays can then be conducted with, for example, emissions from advanced technology engines to compare with results from assays using the standard diesel emissions. This will provide a measure of the relative toxic potency of vehicle emissions that can be directly compared in standard assays.

This project builds upon the toxicity assays developed under the auspices of the Southern California Particle Center, which was sponsored by U.S. EPA. The assays target specific biochemical pathways and proteins that are thought to be involved in the toxicity of pollutants. The pathways include inflammation, cellular oxidation potential and chemical reactions with cellular proteins. Specific chemical assays will be used, as well as specific macrophage cell lines that have been used in previous air pollution toxicity studies. Standard protocols are being developed that can be applied to collected pollutant samples.

The results of this project will provide information to help understand the linkage between sources, chemical composition and the toxicity of emissions from motor vehicles, which will provide a strong scientific basis on which to develop and to assess strategies designed to protect the public from exposure to motor vehicle emissions. This study will provide advanced tools for assessing the relative toxicity of emissions sources and which technologies may be more important in reducing potential health effects from exposures to particles as well as to semi-volatile organic substances. These tools can then be used to quantify the benefits of using alternate and advanced technology to reduce emissions derived from motor vehicles and from other emissions sources. Additionally, development of these toxicity assays will be an invaluable resource to particulate matter exposure and health studies in the Los Angeles Basin.

Technology Deployment and Commercialization

One function of the Clean Fuels Program is to help expedite the deployment and commercialization of low and zero emission technologies and fuels needed to meet the requirements of the AQMP control measures. In many cases, new technologies, although considered “commercially available,” require assistance to fully demonstrate the technical viability to end-users and decision-makers.

The following projects contracted during the CY 2014 reporting period illustrate the impact of the SCAQMD’s technology deployment and commercialization efforts and include: (a) participation in NREL’s Fleet DNA Study; (b) construction of eight retail hydrogen fueling stations; and (c) continuing support for natural gas fueling stations.

Fleet DNA Study

On-road medium- and heavy-duty trucks are a significant source of NO_x emissions in the South Coast Air Basin (SCAB). Consequently, research is needed to determine how this source of emissions can be significantly reduced at minimum cost to facilitate attainment of ambient air quality standards by 2023 and 2032. The SCAQMD is cost-sharing National Renewable Energy Laboratory (NREL)’s Fleet DNA Project to collect and analyze data on truck fleet operations in the SCAB in order to determine the best approach for the deployment of advanced technologies in this sector.

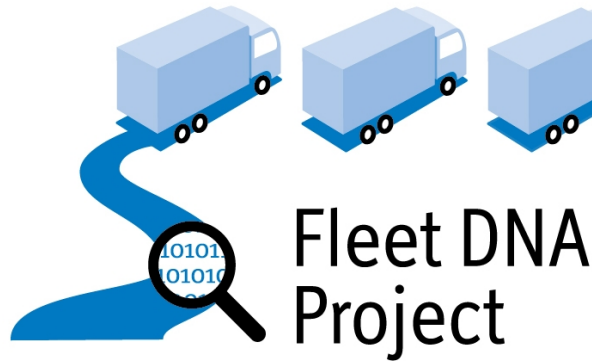

Figure 10: NREL's Fleet DNA Project Logo

This project will be divided into three tasks. The first task is the identification of appropriate fleet vocations by using existing databases to determine emissions inventory contribution. This will involve, for example, the analysis of population, age distribution, annual vehicle miles traveled, and estimated fuel usage for specific fleet vocations. Fleet vocation categories that may be analyzed as part of this task include refuse, urban delivery, drayage and long haul applications. At the conclusion of this task, the highest ranking fleet vocations will be recommended for further data collection and analysis of operational characteristics. The second task is the collection of operational data on three selected fleets representing different vocations. Sufficient operational data will be collected to 'bracket' the range of operation for each vocation, using NREL's Drive-cycle Rapid Investigation, Visualization and Evaluation Tool (DRIVE). The final task entails the use of NREL's Future Automotive Systems Technology Simulator Tool (FASTSim), utilizing drive cycle information generated with DRIVE in the previous task, to evaluate the impact of technology improvements on emissions, vehicle efficiency, performance, cost and operating economics where applicable. Examples of technologies to be assessed include electrification, natural gas, biofuels, aerodynamic improvements, mass reduction and engine sizing.

Construction of Eight Hydrogen Fueling Stations including SCAQMD's Diamond Bar Station

In late 2010, the CEC released a Notice of Proposed Award (NOPA) recommending funding for eight projects that would develop hydrogen fueling infrastructure within the South Coast Air Basin. The eight stations will be strategically located and will play a significant role by providing hydrogen in Southern California in areas with high vehicle densities. The SCAQMD cost-shared this project to offset high initial costs and investment for production and distribution of hydrogen for these stations.

The eight proposed hydrogen fueling stations will be new, publicly accessible, next generation (35 MPa and 70 MPa) hydrogen fueling stations located throughout Southern California, including the construction and upgrade of an existing station at SCAQMD Headquarters in Diamond Bar. They will utilize improved delivery technologies to reduce the cost of transporting low-priced hydrogen made in centrally located facilities with high availability. The station

concepts are simple, modular, expandable to full-sized station capacities, and reduce initial capital costs at the point of use including reduced overall site maintenance costs. The modular design incorporates a minimized station footprint to utilize existing retail gasoline forecourt locations and

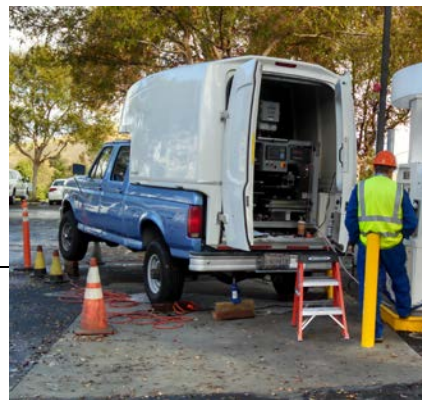

can be readily duplicated at a majority of existing gasoline retail stations in a number of markets for the broadest deployment. Due to the requirements of SB 1505, hydrogen made from renewable resources will also be made available for dispensing on a regular basis.

The first station at SCAQMD will serve as the model for the other modularly constructed delivered-hydrogen stations and will accept major credit cards. EPC LLC entered into a license agreement to operate SCAQMD's hydrogen fueling station in Diamond Bar. The license allows EPC to assign or sublet with SCAQMD's written permission; Air Products and Chemicals, Inc. will be providing equipment maintenance. EPC LLC obtained all permits for construction, maintenance, and operation and will be operating the station for three years, including installation and operation of the point-of-sale (credit card) system. The California Department of Food and Agriculture, Division of Measurement Standards (CDFA/DMS) conducted accuracy testing and issued a Temporary Use permit in December 2014. When final Type Evaluation for accuracy and consistency is successfully completed, this dispenser can be used at multiple stations with reduced testing cost and time.

Figure 12: CDFA/DMS Testing

Figure 11: Hydrogen Dispenser in Diamond Bar

The remaining seven stations will be operational in time for the expected roll out of fuel cell vehicles in the 2015-2016 timeframe.

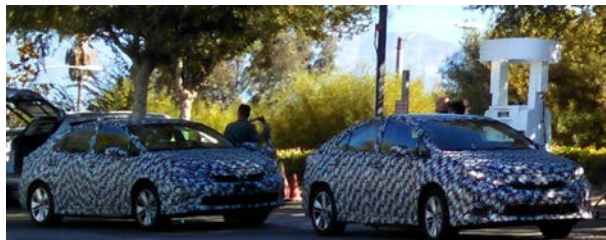

Figure 13: Testing Fuel Cell Vehicles with the New Hydrogen Station

Continuing Support for Natural Gas Fueling Stations

Goods movement throughout Southern California and the increased number of heavy-duty Class 8 LNG-powered trucks used for moving these goods has increased the demand for LNG refueling in this region. One contract modification executed in 2014 was to provide an additional \$1 million in funding to Clean Energy using funds from a CEC AB 118 grant. The \$1 million brought the contract with Clean Energy to \$1.4 million to provide funding for construction, operation and maintenance of three public access LNG projects. All three Clean Energy LNG sites are positioned near major highway corridors which serve as goods movement conduits for many heavy-duty vehicles in the South Coast and the Coachella Valley Air Basins. The three stations are located as follows: Fontana (San Bernardino County) which is adjacent to the I-10 corridor; Coachella (eastern portion of Riverside County) which is at the junction of Interstate 10 and highway 86, a main thoroughfare to Imperial County; and Perris (western Riverside County) which is adjacent to Interstate 215 and which serves as a thoroughfare to San Diego County.

Two of the three stations, Fontana and Coachella, were completed in 2013 and are now in operation. The Perris station is expected to be commissioned in the first part of 2015. All



Figure 14: LNG Station at Truck Stop Center on Valley Blvd. in Fontana



three stations are located at existing and established conventional truck fueling stops.



The Fontana location also includes CNG

Figure 15: LNG Station at Love's Travel Stop on Dillon Road in Coachella

refueling and is dispensing 45,000 GGE of CNG and 20,000 DGE of LNG per month. Coachella is currently dispensing 36,000 DGE of LNG and completing nearly 1,200 vehicle fueling transactions per month.

The Perris station is expected to have a starting annual throughput of 300,000 DGE of LNG. These three stations will increase the public access LNG facility count by 20% in SCAQMD's jurisdiction and demonstrate the viability of natural gas as an alternative fuel for the goods movement sector.

Figure 16: LNG Station under Construction at Arco Truck Stop on Cajalco Expressway in Perris

2014 FUNDING & FINANCIAL SUMMARY

The SCAQMD Clean Fuels Program supports clean fuels and technologies that appear to offer the most promise in reducing emissions, promoting energy diversity, and in the long term, providing cost-effective alternatives to current technologies. In order to address the wide variety of pollution sources in the Basin and the need for reductions now and in the future, using revenue from a \$1 motor vehicle registration fee (see Program Funding on page 6), the SCAQMD seeks to fund a wide variety of projects to establish a diversified technology portfolio to proliferate choices with the potential for different commercial maturity timing. Given the evolving nature of technology and changing market conditions, such a representation is only a “snapshot-in-time,” as reflected by the projects approved by the SCAQMD Governing Board.

As projects are approved by the SCAQMD Governing Board and executed into contracts throughout the year, the finances may change to reflect updated information provided during the contract negotiation process. As such, the following represents the status of the Clean Fuels Fund as of December 31, 2014.

Funding Commitments by Core Technologies

The SCAQMD continued its successful leveraging of public funds with outside investment to support the development of advanced clean air technologies. During the period January 1 through December 31, 2014, a total of 72 contracts, projects or studies that support clean fuels were executed or amended, as shown in Table 2 (page 28). The major technology areas summarized are (listed in order of funding priority during the CY): hybrid/electric technologies and infrastructure, engine systems, natural gas infrastructure and deployment, hydrogen technology and infrastructure, mobile fuel cell technologies, health impacts studies, fuels and emission studies, and outreach and technology transfer. The distribution of funds based on technology area is shown graphically in Figure 17 (page 26). This wide array of technology support represents the SCAQMD’s commitment to researching, developing, demonstrating and deploying potential near-term and longer-term technology solutions.

The project commitments that were contracted or purchased for the 2014 reporting period are shown below with the total projected project costs:

• SCAQMD Clean Fuels Fund Contribution	\$14,268,944
• Total Cost of Clean Fuels Projects	\$64,666,588

Each year, the SCAQMD Governing Board approves funds to be transferred to the General Fund Budget for Clean Fuels administration. For 2014, the Board transferred \$850,000 for workshops, conferences, co-sponsorships and outreach activities as well as postage, supplies and miscellaneous costs for participation in special conferences. Only the funds committed by December 31, 2014, are included within this report. Any portion of the Clean Fuels Funds not spent by the end of Fiscal Year 2014-15 ending June 30, 2015, will be returned to the Clean Fuels Fund.

Partially included within the SCAQMD contribution are supplemental sponsorship revenues from various organizations that support these technology advancement projects. This supplemental revenue for pass-through contracts executed in 2014 totaling \$5,963,707 is listed within Table 3 (page 31).

Appendix B lists the 121 Clean Fuels Fund contracts that were open and active as of January 1, 2015.

For Clean Fuels executed and amended contracts, projects and studies in 2014, the average SCAQMD contribution is approximately 22 percent of the total cost of the projects, identifying that each dollar from the SCAQMD was leveraged with nearly five dollars of outside investment. The typical leverage amount is \$3-\$4 for every \$1 of SCAQMD Clean Fuels funds, but 2014 notably had a couple of significant contracts, significant both in funding and in the impact they hopefully will make in strides toward developing and commercializing clean transportation technologies.

During 2014, the distribution of funds for SCAQMD executed contracts, purchases and contract amendments with additional funding for the Clean Fuels Program totaling approximately \$14.3 million are shown in Figure 17 below.

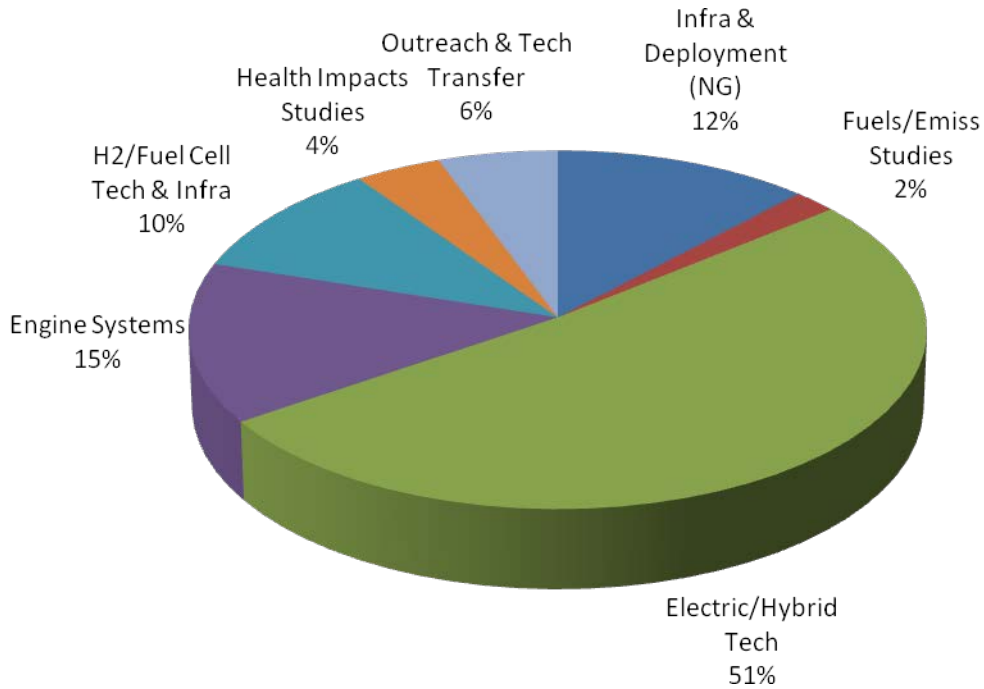

Figure 17: Distribution of Funds for Executed Clean Fuels Projects CY 2014 (\$14.3 million)

Table 2 (page 28) provides a breakdown of these \$14.3 million awards. Table 3 (page 31) provides information on outside funding recognized and received into the Clean Fuels Fund (nearly \$6 million) for contracts executed in CY 2014. Additionally, the SCAQMD continued to seek funding opportunities and Table 4 (page 32) lists the additional \$19,956,690 awarded in 2014 for projects that will be implemented as part of the Clean Fuels Program or which align well or will be complementary to the Clean Fuels Program.

Review of Audit Findings

State law requires an annual financial audit after the closing of each SCAQMD’s fiscal year. The financial audit is performed by an independent Certified Public Accountant selected through a competitive bid process. For the fiscal year ended June 30, 2014, the firm of Simpson and Simpson, CPAs conducted the financial audit. As a result of this financial audit, a Comprehensive Annual Financial Report (CAFR) was issued. There were no adverse internal control weaknesses with regard to SCAQMD financial statements, which include the Clean Fuels Program revenue and expenditures. Simpson and Simpson CPAs gave the SCAQMD an “unmodified opinion,” the

highest obtainable. Notably, the SCAQMD has achieved this rating on all prior annual financial audits.

Project Funding Detail by Core Technologies

The 72 new and continuing contracts, projects and studies that received SCAQMD funding in 2014 are summarized in Table 2, together with the funding authorized by the SCAQMD and by the collaborating project partners.

Table 2: Contracts Executed or Amended (w/\$) between January 1 & December 31, 2014

Contract	Contractor	Project Title	Start Term	End Term	SCAQMD \$	Project Total \$
Electric/Hybrid Technologies & Infrastructure						
13396	Transportation Power Inc.	Develop & Demonstrate Class 8 Zero-Emission Electric Trucks	04/19/13	12/31/16	375,000	2,285,368
14062	Siemens Industry Inc.	Develop & Demonstrate Catenary Zero Emissions Goods Movement System & Develop & Demonstrate Diesel Catenary Hybrid Electric Trucks	07/14/14	07/13/18	5,500,000	14,780,000
14156	Galpin Motors Inc. (Galpin Ford)	Lease of Two Fusion Energi & One C-Max Energi PHEVs for a Three-Year Period	01/28/14	01/27/17	49,298	49,298
14184	Clean Fuel Connection, Inc.	DC Fast Charging Network Provider	04/04/14	06/30/20	250,000	1,268,000
14222	Odyne Systems, LLC	Develop & Demonstrate Plug-In Hybrid Electric Retrofit System for Class 6 to 8 Trucks	04/24/14	04/23/16	389,000	2,226,571
14224	Complete Coach Works	Develop & Demonstrate Long Range All-Electric Transit Bus	04/24/14	07/30/15	395,000	867,182
14256	National Strategies LLC	Develop & Demonstrate Vehicle-To-Grid Technology	09/05/14	03/04/18	250,000	3,377,689
14323	Selman Chevrolet Company	Lease Two 2014 Chevrolet Volt Extended-Range Electric Vehicles for Three Years	03/28/14	03/27/17	30,932	30,932
15021	Transportation Power Inc.	Upgrade & Demonstrate Two Electric Yard Tractors	07/14/14	12/31/15	75,000	405,000
Various	Various	Install & Upgrade EV Charging Infrastructure (Administer SoCalEV Infrastructure Project)	01/22/14	10/10/14	0	0
Direct Pay	ATVLS, Inc.	Install Electric Vehicle Chargers	TBD	TBD	7,306	7,306
Direct Pay	Clean Fuel Connection, Inc.	Install Electric Vehicle Chargers	TBD	TBD	5,388	5,388
Direct Pay	Croxton Electric	Install Electric Vehicle Chargers	TBD	TBD	6,685	6,685

Engine Systems

14364	Cummins Inc.	Develop, Integrate & Demonstrate Ultra-Low Emission Natural Gas Engines for On-Road Heavy-Duty Vehicles	07/14/14	08/20/16	2,061,000	3,869,000
-------	--------------	---	----------	----------	-----------	-----------

Infrastructure and Deployment (NG)

09308	Trillium CNG	Maintain & Manage SCAQMD's Fast-Fill CNG Refueling Station	06/17/09	11/30/14	54,000	54,000
12851	Clean Energy	Install, Operate & Maintain Three LNG Fueling Stations (Fontana, Coachella & Perris)	10/05/12	12/31/18	1,000,000	3,477,323
14219	City of West Covina	Upgrade CNG Station at City Yard	05/15/14	06/15/17	200,000	618,429
14311	Southern California Gas Company	Construct & Operate CNG Fueling Station in Murrieta for SoCalGas	07/11/14	12/31/17	217,000	1,385,000

Table 2: Contracts Executed or Amended (w/\$) between January 1 & December 31, 2014

Contract	Contractor	Project Title	Start Term	End Term	SCAQMD \$	Project Total \$
Infrastructure and Deployment (cont'd)						
15438	United Parcel Service, Inc.	Refurbish & Upgrade Ontario UPS LCNG Infrastructure	12/31/14	06/30/18	246,707	484,535
Hydrogen Technologies & Infrastructure						
13259	Air Products and Chemicals, Inc.	Hydrogen Station Operation & Maintenance for Five Cities Hydrogen Program	03/26/13	03/31/15	90,000	90,000
15020	University of California Irvine	Develop Sampling & Testing Protocols for Analyzing Impurities in Hydrogen	08/13/14	04/12/15	114,500	114,500
15150	Air Products and Chemicals, Inc.	Install & Upgrade Eight Hydrogen Fueling Stations (including SCAQMD's Diamond Bar Station)	10/10/14	04/09/19	1,000,000	17,044,216
15366	EPC LLC	Operate & Maintain Publicly Accessible Hydrogen Fueling Station at SCAQMD Headquarters	10/10/14	09/14/17	0	0
15419	SunLine Transit Agency	Disposition of Dispenser from Electrolyzer Hydrogen Station Demonstration at SCAQMD Headquarters	12/24/14	12/23/15	0	0
Direct Pay	Smart Chemistry Corp.	Conduct Hydrogen Quality Sampling & Analysis at Three Hydrogen Stations (Diamond Bar, Burbank & Newport Beach)	11/19/13	1/19/14	10,350	10,350
Direct Pay	Hydrogen Fueling Station	Additional Support for California Fuel Cell Partnership's Hydrogen Fueling Activities	01/01/14	06/04/14	10,000	127,000
Purchase Order	MKS Instruments	Purchase FTIR to Perform Hydrogen Fuel Quality Testing	08/07/14	1/23/15	91,768	91,768
Mobile Fuel Cell Technologies						
14622	California State University Long Beach Foundation	CSULB CEERS Student Educational Project to Demonstrate Graphene Fuel Cell Catalysts	08/05/14	05/31/15	28,000	28,000
15388	Bevilacqua-Knight Inc.	Participate in California Fuel Cell Partnership for CY 2014 & Provide Support for Regional Coordinator	01/01/14	12/31/14	137,800	1,676,800
Health Impacts Studies						
12865	University of California Los Angeles	Develop Quantitative Cellular Assays for Use in Understanding the Chemical Basis of Air Pollutant Toxicity	06/08/12	07/31/15	319,553	319,553
14171	Southern California Research Center/Allergy & Asthma Associates of Southern California	Risk of Incident Asthma among Children from In-Utero Exposures to Traffic Related Pollutants	09/22/14	03/21/16	99,670	317,119
14172	University of California Irvine	The Relation of Airway & Systemic Oxidative Stress to Particulate Air Pollution Exposures in an Elderly Cohort	02/17/14	08/16/15	159,974	376,368

Table 2: Contracts Executed or Amended (w/\$) between January 1 & December 31, 2014

Contract	Contractor	Project Title	Start Term	End Term	SCAQMD \$	Project Total \$
Fuels/Emissions Studies						
13402	University of California Davis-Office of Research	Next Sustainable Transportation Energy Pathways (STEPS) Program	05/02/14	07/01/16	120,000	2,760,000
14162	National Renewable Energy Laboratory	Utilization of Fleet DNA Approach & Capabilities to Provide Vehicle Vocational Analysis in SCAQMD	02/26/14	12/30/15	174,985	199,985
Outreach & Technology Transfer						
12376	University of California Riverside/CE-CERT	Technical Assistance with Alternative Fuels, Biofuels, Emissions Testing & Zero-Emission Transportation Technology	06/13/14	05/31/16	75,000	75,000
12381	Integra Environmental Consulting Inc.	Technical Assistance with Alternative Fuels, Fuel Cells, Emissions Analysis & Aftertreatment Technologies	06/21/12	05/31/16	75,000	75,000
13194	Clean Fuel Connection, Inc.	Technical Assistance with Alternative Fuels, Renewable Energy & EVs, Program-Related Activities for AFVs, Lawn Mower Exchange, Conferences & Outreach	12/07/12	06/30/15	50,000	50,000
14185	Three Squares Inc.	Conduct Education Outreach for the Basin DC Fast Charging Network Project	04/11/14	06/30/15	49,183	49,183
15344	Clean Fuel Connection, Inc.	Technical Assistance with Alternative Fuels, Electric Vehicles, Charging & Fueling Infrastructure & Renewable Energy	09/22/14	09/22/16	60,000	60,000
15369	Breakthrough Technologies Institute, Inc.	Technical Assistance with Low- & Zero-Emission Vehicles, Fuel Cells, Stationary Applications & Emissions Analyses	11/07/14	11/06/16	30,000	30,000
15380	ICF Resources LLC	Technical Assistance with Goods Movement, Alternative Fuels & Zero-Emission Transportation Technologies	12/12/14	12/11/16	30,000	30,000
15415	Gladstein, Neandross & Associates, LLC	Technical Assistance with Alternative Fuels & Fueling Infrastructure, Emissions Analysis & On-Road Sources	11/07/14	11/06/16	60,000	60,000
Transfer	Transfer from Clean Fuels	Participation in California Natural Gas Vehicle Partnership for Fiscal Years 2014-15 & 2015-16	07/11/14	07/11/14	25,000	145,000
Direct Pay	Three Squares, Inc.	Technical Assistance for EV Charging Infrastructure Grant Preparation	02/01/14	02/06/14	15,307	15,307
Direct Pay	Transportation Research Board	Participation for CY 2014 Membership in Transportation Research Board & Support Minority Student Fellows Program	01/01/14	12/31/14	36,500	260,000

Table 2: Contracts Executed or Amended (w/\$) between January 1 & December 31, 2014

Contract	Contractor	Project Title	Start Term	End Term	SCAQMD \$	Project Total \$
Outreach & Technology Transfer (cont'd)						
Direct Pay	Various	Cosponsor 22 Conferences, Workshops & Events plus 5 Memberships	01/01/14	12/31/14	294,038	5,462,933

Table 3: Supplemental Grants/Revenue Received into the Clean Fuels Fund (31) in CY 2014

Revenue Agreement #	Revenue Source	Project Title	Contractor	SCAQMD Contract #	Award Total \$
#10685	U.S. DOE Clean Cities DE-EE0002545	Refurbish & Upgrade Ontario UPS LCNG Infrastructure	United Parcel Service, Inc.	#15438	150,000
#12152 (Amd #2)	CEC AB 118 Program ARV-10-054	Install Three New LNG Stations	Clean Energy	#12851	1,000,000
#12286	CEC AB 118 Program ARV-10-035	Refurbish & Upgrade Ontario UPS LCNG Infrastructure	United Parcel Service, Inc.	#15438	96,707
#13034	CEC AB 118 Program ARV-11-025	Construct CNG Fueling Station in Murrieta for SoCalGas	Southern California Gas Company	#14311	217,000
#14024 & #15517	CEC AB 118 Program 600-12-011 & 600- 14-003	Develop & Demonstrate Catenary Zero Emissions Goods Movement System	Seimens Industry Inc.	#14062	3,000,000
#14051	CEC AB 118 Program ARV-12-053	Implement South Coast Air Basin DC Fast Charging Network	Clean Fuel Connection, Inc.	#14184	250,000
#14146	Southern California Gas Company	Develop, Integrate & Demonstrate Ultra-Low Emission Natural Gas Engines for On-Road Heavy-Duty Vehicles	Cummins Inc.	#14364	250,000
#15022	CEC 600-13-018	Develop, Integrate & Demonstrate Ultra-Low Emission Natural Gas Engines for On-Road Heavy-Duty Vehicles	Cummins Inc.	#14364	\$1,000,000
<i>Table 3 lists revenue recognized by SCAQMD into the Clean Fuels Fund (31) only if the pass-through contract was executed during the reporting CY (2014).</i>					\$5,963,707

Table 4: Summary of Federal & State Funding Awarded between Jan. 1 & Dec. 31, 2014

Awarding Entity or Program	Award Date	Purpose	Contractors	Award Total \$/Fund
CEC AB 118 Program ARV-12-053 (#14051 Amd #1)	Exe 12/15/14	Implement South Coast Air Basin DC Fast Charging Network	Clean Fuel Connection Inc.	420,000 Fund 31 (Clean Fuels)
CEC AB 118 Program ARV-13-026 (#15441)	07/03/14	Implement South Coast Air Basin DC Fast Charging Network	Clean Fuel Connection Inc.	500,000 Fund 31 (Clean Fuels)
U.S. DOE/NETL (#15390)	08/21/14	Develop & Demonstrate Zero Emission Fuel Cell Range Extended Electric & Hybrid Electric Drayage Trucks	U.S. Hybrid, TransPower, CTE, GTI and International Rectifier	9,725,000 Fund 61
CEC	12/05/14 Brd Mtg	Develop and Demonstrate Zero Emission Fuel Cell Range Extended Electric and Hybrid Electric Drayage Trucks	U.S. Hybrid, TransPower, CTE, GTI and International Rectifier	2,400,000 Fund 61
LADWP	12/05/14 Brd Mtg	Develop and Demonstrate Zero Emission Fuel Cell Range Extended Electric and Hybrid Electric Drayage Trucks	U.S. Hybrid, TransPower, CTE, GTI and International Rectifier	1,000,000 Fund 61
San Pedro Bay Ports' Technical Advancement Program	12/05/14 Brd Mtg	Develop and Demonstrate Zero Emission Fuel Cell Range Extended Electric and Hybrid Electric Drayage Trucks	U.S. Hybrid, TransPower, CTE, GTI and International Rectifier	1,133,979 Fund 61
Southern California Gas Company	12/05/14 Brd Mtg	Develop and Demonstrate Zero Emission Fuel Cell Range Extended Electric and Hybrid Electric Drayage Trucks	U.S. Hybrid, TransPower, CTE, GTI and International Rectifier	250,000 Fund 61
CARB/BAR AB 118	12/05/14 Brd Mtg	Implement the Retirement and Replacement Component of the Enhanced Fleet Modernization Program	Foundation for California Community Colleges; Gladstein, Neandross & Associates; and Opus Inspection	1,400,000 Fund 56
U.S. EPA CATI A-00909414-1 (Amd #1)	07/21/14	Install and Test Air Filtration Systems in School Buses and Upgrade and Demonstrate Two Electric Yard Tractors	IQAir & TransPower	500,000 Fund 17
CEC AB 118 ARV-13-056 (#14685)	03/12/14	Support Hydrogen Readiness in Early Market Communities	Bevilacqua-Knight, Inc.	297,460 Fund 55
POLB/City of Long Beach (#14359)	04/04/14 Brd Mtg	Demonstrate Barge-Mounted Emission Control System	Advanced Cleanup Technologies, Inc.	2,063,624 Fund 17
U.S. EPA/ DERA	02/07/14 Brd Mtg	Convert and Demonstrate Two Diesel School Buses to Electric Buses with V2G Capability and Replace One Diesel School Bus with an Electric School Bus	Torrance and Newport-Mesa Unified School Districts	156,000 Fund 33

Table 4: Summary of Federal & State Funding Awarded between Jan. 1 & Dec. 31, 2014

Awarding Entity or Program	Award Date	Purpose	Contractors	Award Total \$/Fund
U.S. EPA/ DERA	08/21/14	Replace Diesel School Buses with Electric School Buses	Colton and Los Angeles Unified School Districts	110,627 Fund 33
<p><i>Table 4 provides a comprehensive summary of revenue <u>awarded</u> to SCAQMD during the reporting CY (2014) if it will be considered part of, or complementary to, the Clean Fuels Program, regardless of whether the pass-through contract has been executed.</i></p>				\$19,956,690

Project Summaries by Core Technologies

The following represents summaries of the contracts, projects and studies executed, or amended with additional dollars, in 2014. They are listed in the order found in Table 2 by category and contract number. The summaries provide the project title, contractors and subcontractors, SCAQMD cost-share, cosponsors and their respective contributions, contract term and a description of the projects as required by H&SC Section 40448.5.1(d).

Electric/Hybrid Technologies

13396: Develop & Demonstrate Class 8 Zero Emission Electric Trucks

Contractor: Transportation Power Inc.	SCAQMD Cost-Share	\$ 375,000
	Cosponsors	
	California Energy Commission	1,450,364
	San Pedro Bay Ports' Technology Advancement Program	300,000
	Transportation Power Inc.	160,004
Term: 04/19/13 – 12/3/16	Total Cost:	\$ 2,285,368

In October 2012, TransPower was awarded \$1,142,070, as part of a DOE grant, to develop and demonstrate four Class 8 battery electric drayage trucks in real world drayage operations at the Ports of Los Angeles and Long Beach. Subsequent to the award, TransPower received additional funding from CEC and the San Pedro Bay Ports' Technology Advancement Program to develop three more electric drayage trucks for the demonstration. This contract modification is to cost-share the development of the three additional trucks for a total of seven demonstration trucks. In addition, this modification also includes design upgrades to the electric drive system incorporating technology advancements and improvements gained from the operations of earlier prototypes. The upgrades will help to enhance the vehicle performance and operating efficiency as well as to reduce assembly costs, making the vehicles more viable and well-positioned for commercialization.

14062: Develop & Demonstrate Catenary Zero Emissions Goods Movement System & Develop & Demonstrate Diesel Catenary Hybrid Electric Trucks

Contractor: Siemens Industry Inc.	SCAQMD Cost-Share <i>(partially received as pass-through funds)</i>	\$ 5,500,000
	Cosponsors	
	Port of Long Beach	2,000,000
	Los Angeles County Metropolitan Transportation Authority "Metro"	2,000,000
	Port of Los Angeles China Shipping Settlement	4,000,000
	Siemens Industry Inc.	1,280,000
Term: 07/14/14 – 07/13/18	Total Cost:	\$ 14,780,000

Siemens Industry Inc. (Siemens) has designed and demonstrated a catenary truck technology, eHighway, in Germany on a European truck chassis. For this project, Siemens proposes to bring the eHighway technology to southern California with their partner Volvo and develop and demonstrate a catenary plug-in hybrid electric truck technology. The hybrid drive system will extend the operating range of the truck beyond the all-electric range of the catenary system, enabling the truck to perform regional drayage operations and bridge gaps in catenary infrastructure as it is deployed on a regional level. Siemens and Volvo propose to develop and integrate two Mack Granite Vision diesel hybrid electric class 8 trucks configured to operate on the catenary system. The first truck will be used for integration and testing of the pantograph and electrical hybrid drive and will be evaluated on Siemens catenary test track in Germany. The second truck will leverage the same plug-in hybrid electric architecture being developed by Volvo under a separate SCAQMD project. The vehicle will use Volvo’s current hybrid 150kW electro-mobility propulsion system will be upgraded with a pantograph to operate on the eHighway system.

14156: Lease of Two Fusion Energi & One C-Max Energi PHEVs for a Three-Year Period

Contractor: Galpin Motors Inc. (Galpin Ford)	SCAQMD Cost-Share	\$ 49,298
	Cosponsors	
	Federal Tax credit \$3,750 partially offset by Ford lease financing plus California Clean Vehicle Rebate of \$1500 per PHEV	
Term: 01/28/14 01/27/17	Total Cost:	\$ 49,298

The SCAQMD operates a number of alternative fuel vehicles, including electric vehicles, fuel cell vehicles and plug-in hybrid-electric vehicles (PHEVs). The primary objective of having these vehicles as part of the SCAQMD Fleet Demonstration Program is to continue to support the use of zero-emission vehicles. The three Ford PHEVs provide 19 miles all electric range in a five-passenger sedan (Fusions) or hatchback (C-Max), with over 500 miles total range including gasoline.

14184: DC Fast Charging Network Provider

Contractor: Clean Fuel Connection, Inc.	SCAQMD Cost-Share <i>(received as pass-through funds)</i>	\$ 250,000
	Cosponsors	
	Clean Fuel Connection, Inc.	25,000
	eVgo	693,800
	Nissan	300,000
Term: 04/04/14 – 06/30/20	Total Cost:	\$ 1,268,800

Clean Fuel Connection, Inc. (CFCI) was selected as the network provider for the 26-site DC fast charging network. CFCI is working in partnership with NRG/eVgo to serve as the installer and network provider. CFCI has installed over 8,000 EVSE since 1999 and is one of the most experienced installers of EVSE in the U.S. The 26 sites will be in addition to NRG/eVgo’s CPUC

settlement of installing 200 DC fast chargers in California and will be integrated into the eVgo network. CFCI will operate the network for five years beyond the date of installation and will provide pay per use and subscription payment models to users. Installation at sites will begin in 2015 and be completed in early 2016. Subsequent to the execution of this contract with CFCI, the CEC issued a Notice of Proposed Award (NOPA) announcing the SCAQMD had been awarded \$500,000 to implement six additional sites to their DC fast charging network and also amended their original award increasing it to a total of \$720,000. CFCI's contract will be amended in 2015 to add these additional funds. Total CEC funding is \$1.22 million for a 26-site network.

14222: Develop & Demonstrate Plug-In Hybrid Electric Retrofit System for Class 6 to 8 Trucks

Contractor: Odyne Systems, LLC	SCAQMD Cost-Share	\$ 389,000
	Cosponsors	
	California Energy Commission	916,000
	Odyne Systems, LLC	921,000
Term: 04/24/14 – 04/23/16	Total Cost:	\$ 2,226,000

The objectives of this project are to develop and design a retrofit plug-in hybrid electric system for work truck applications, such as bucket trucks, digger derricks, and underground utility trucks. During the two-year period of the project, the Odyne Systems will develop and evaluate concept designs, produce a selected concept, and evaluate one plug-in hybrid-electric medium- and heavy-duty work truck with extended stationary engine-off technology. The one vehicle will be deployed in the South Coast Air Basin. The primary objectives of this project are: 1) to improve specific aspects of the existing system through the use of smaller, lower cost components; 2) to optimize the system and selected powertrain components for high volume production to enhance commercial appeal through lower-cost products and components; 3) to match the size of the power electronics and energy storage device to customer duty cycle and work practice; 4) to quantify improvements in fuel economy and emissions. The project will gather vehicle and component performance data during deployment that will enable the operating cost and environmental impact of the vehicle to be assessed.

14224: Develop & Demonstrate Long Range All-Electric Transit Bus

Contractor: Complete Coach Works	SCAQMD Cost-Share	\$ 395,000
	Cosponsors	
	U.S. Hybrid	44,500
	EV Grid	27,000
	Complete Coach Works	390,200
Term: 04/24/14 – 07/30/15	Total Cost:	\$ 856,700

Complete Coach Works is one of the largest bus remanufacturing companies in the nation and has undertaken initial development efforts to produce an electric bus for transit applications. Leveraging their previous work, Complete Coach Works will design, develop and demonstrate their third generation electric bus concept in this project. The bus would be built off of a refurbished chassis incorporating significant improvements to the electric drive system. The improvements would be focused on making the bus more competitive with conventional transit buses on the initial purchase cost as well as on operating costs. The drive system is locally

sourced from U.S. Hybrid with a higher power output and the battery pack will be manufactured by EV Grid applying a more power dense lithium ion chemistry to trim system weight and utilizing high-volume cylindrical battery cells to further reduce the production cost. Complete Coach Works is targeting a driving range of 150 miles, which would satisfy the needs of approximately 80% of their customer base and still be a commercially marketable product. The electric bus will be demonstrated in revenue service with different transit agencies in the South Coast Air Basin to evaluate its performance and reliability as well as to quantify its operating cost relative to traditional vehicles in their fleets.

14256: Develop & Demonstrate Vehicle-To-Grid Technology

Contractor: National Strategies, LLC	SCAQMD Cost-Share	\$ 250,000
	Cosponsors	
	California Energy Commission	1,473,488
	National Strategies, LLC	1,654,201
Term: 09/05/14 – 03/04/18	Total Cost:	\$ 3,377,689

National Strategies proposed a Vehicle-to-Grid (V2G) Electric School Bus Demonstration Project that seeks to demonstrate if V2G capable school buses can overcome the capital cost barriers associated with EV technology and be financially viable on a total cost-of-ownership basis. In October 2013, the CEC made an award to National Strategies to develop and demonstrate six electric school buses with vehicle-to-grid and vehicle-to-building functionality (V2G/B) in school districts across California. School buses are ideal for V2G/B operation since they typically operate in the morning and afternoon for a few hours but remain parked most of the day. In this proposed project, two of the zero-emission school buses will be demonstrated in the South Coast Air Basin with Torrance Unified School District. National Strategies will convert two type C school buses for Torrance Unified School District that will utilize electric drive systems installed into existing OEM school bus chassis.

14323: Lease Two 2014 Chevrolet Volt Extended-Range Electric Vehicles for Three Years

Contractor: Selman Chevrolet Company	SCAQMD Cost-Share	\$ 30,932
	Cosponsors	
	Federal Tax credit \$7,500 partially offset by Chevy lease financing plus CA Clean Vehicle Rebate of \$1500 per PHEV	
Term: 03/28/14 - 03/27/17	Total Cost:	\$ 30,932

The SCAQMD operates a number of alternative fuel vehicle (AFVs), including electric vehicles (EV), fuel cell vehicles (FCVs) and plug-in hybrid-electric vehicles (PHEVs). The primary objective of having these vehicles as part of the SCAQMD’s Fleet Demonstration Program is to continue to support the use of zero emission vehicles. The Chevy Volts provide 38 miles all electric range with about 300 miles total range including gasoline.

15021: Upgrade & Demonstrate Two Electric Yard Tractors

Contractor: Transportation Power Inc.	SCAQMD Cost-Share	\$ 75,000
	Cosponsor	330,000
	U.S. EPA FY14 CATI Grant (received as pass-through funds-- but not into Clean Fuels Fund)	
Term: 07/14/14 – 12/31/15	Total Cost:	\$ 405,000

The objectives of this project are to: (i) upgrade two prototype electric yard tractors to reflect lessons learned during a previous demonstration and incorporate Transportation Power Inc.'s TransPower latest ElecTruck™ technology; and (ii) demonstrate the upgraded tractors at container/trailer handling locations in the SCAQMD. During this demonstration, the tractors will be equipped with data logging instruments to record vehicle, drive system and battery system data. This demonstration will help encourage deployment of electric yard tractors and other cargo handling equipment.

Various: Install & Upgrade EV Charging Infrastructure (Administer SoCalEV Infrastructure Project)

Contractor: Various	SCAQMD Cost-Share	\$ 0
Term: 08/05/13 – 06/30/15	Total Cost	\$ 0

State, federal and local funds are currently being invested to support battery EV, plug-in hybrid EV and charging infrastructure. And while Southern California has an established network of public charging for EVs, the infrastructure is mostly obsolete. In 2013, the LADWP asked the SCAQMD to administer this project, which was previously awarded \$840,750 by CEC. During that same CY, the SCAQMD executed the first five agreements - Memorandum of Agreement (MOA) - with members of the SoCalEV Regional Collaborative to install as well as upgrade existing public EV charging infrastructure at key Southern California locations. In 2014 the SCAQMD executed another 12 agreements with members of the SoCalEV Regional Collaborative. Data will be collected on charger utilization, charging use patterns, operating costs, electricity used and real world electric range of EVs. The work with all the members will be completed in 2015. (A complete listing of these MOAs can be found in Appendix B-Open Contracts.)

Direct Pay: Load Testing & Repair of Electric Vehicle Chargers

Contractor: ATVLS, Inc.	SCAQMD Cost-Share	\$ 7,306
Term: 01/15/14 – 03/07/14	Total Cost	\$ 7,306

This project provides funds for conducting load testing at several sections of the SCAQMD's Headquarters parking lot to determine electrical demand and need to replace or upgrade transformers, electrical panels and circuit breakers as part of a preliminary site assessment to increase the number of electric vehicle chargers onsite. A Clipper Creek Level 2 charger was also replaced in the parking area near the front lobby entrance after two years of service. The warranty on the charger had expired and the charger could not be repaired. This charger had originally been installed under a CEC Reconnect California grant awarded to Clipper Creek to upgrade old electric vehicle chargers to Level 2 chargers with J1772 connectors.

Direct Pay: Procure Electric Vehicle Chargers

Contractor: Clean Fuel Connection, Inc.	SCAQMD Cost-Share	\$ 5,388
Term: 02/25/14 – 03/04/14	Total Cost	\$ 5,388

This project provides funds for the demonstration of Level 2 electric vehicle charging infrastructure from several manufacturers including Coulomb Technologies, ECotality, Clipper Creek and Schneider Electric. Clean Fuel Connection, Inc. purchased and installed two Level 2 charging stations in SCAQMD’s parking lot behind Conference Room CC8 to provide additional charging for SCAQMD Board Members and staff as part of SCAQMD’s Fleet Demonstration Program.

Direct Pay: Install Electric Vehicle Chargers

Contractor: Croxton Electric	SCAQMD Cost-Share	\$ 6,685
Term: 03/3/14 – 03/4/14	Total Cost	\$ 6,685

This project provides funds for the demonstration of Level 2 electric vehicle charging infrastructure from several manufacturers including Coulomb Technologies, ECotality, Clipper Creek and Schneider Electric. Croxton Electric installed two Level 2 charging stations in the SCAQMD’s parking lot behind Conference Room CC8 to provide additional charging for SCAQMD Board Members and staff as part of SCAQMD’s Fleet Demonstration Program.

Engine Systems

14364: Develop, Integrate & Demonstrate Ultra-Low Emission Natural Gas Engines from On-Road Heavy-Duty Engines

Contractor: Cummins Inc.	SCAQMD Cost-Share <i>(partially received as pass-through funds)</i>	\$ 2,061,000
	Cosponsor	
	Cummins Inc.	1,808,000
Term: 07/14/14 – 08/20/16	Total Cost:	\$ 3,869,000

The objective of this project is to develop, integrate and demonstrate a natural gas engine suitable for on-road Class 8 heavy-heavy duty vehicle applications. The emissions targets are 0.02 g/bhp-hr NO_x, 0.01 g/bhp-hr PM, 0.14 g/bhp-hr NMHC, and 15.5 g/bhp-hr CO or lower, as measured using the U.S. EPA heavy-duty engine certification test procedure. Ammonia emissions will also be measured and methods to attain 10 ppm or lower are to be incorporated in the engine design. In addition, the engine design shall achieve minimal, if any, fuel economy penalties compared to similar 2010 diesel engines.

Infrastructure & Deployment

09308: Maintain & Manage SCAQMD’s Fast-Fill CNG Refueling Station

Contractor: Trillium CNG	SCAQMD Cost-Share	\$ 54,000
Term: 06/17/09 – 11/30/14	Total Cost:	\$ 54,000

In late 2014, the SCAQMD Board authorized execution of a consecutive contract with Trillium CNG to ensure continued operation of the public access CNG station at SCAQMD headquarters. Concurrently, the Board approved the release of an RFP to solicit bids from contractors interested in assuming ownership and improving the now 12 year old CNG refueling facility. This contract, originally executed in 2009 with Trillium CNG (formerly Pinnacle), was allowed to expire so a new interim contract could be negotiated with Trillium CNG. The CNG station is currently operating without interruption and the RFP for a new owner/operator has closed and proposals are being evaluated. This station currently dispenses about 14,000 GGE/month and fuels about 2000 vehicles per month. Approximately 80% of the fuel dispensed is to non-SCAQMD vehicles.

12851: Install, Operate & Maintain Three LNG Fueling Stations (Fontana, Coachella & Perris)

Contractor: Clean Energy	SCAQMD Cost-Share <i>(received as pass-through funds)</i>	\$ 1,000,000
	Cosponsor	
	Clean Energy	2,477,323
Term: 10/05/12 - 12/31/18	Total Cost:	\$ 3,477,323

In late 2011 the SCAQMD received and executed a \$2.6 million grant from CEC after applying for funding under AB 118 Program PON-09-006 for multiple natural gas stations. This grant was subsequently amended in 2013 and 2014. This modification executed in 2014 provides an additional \$1 million to Clean Energy for three public access LNG projects. The Fontana and Coachella stations were both new stations completed in 2013 and are now in operation. Fontana adds LNG fueling capabilities to an existing conventional truck stop and is dispensing 45,000 GGE CNG and 20,000 DGE LNG per month. Coachella is designed to support heavy-duty trucks off Interstate 10 and has also undergone site improvements. Coachella is currently dispensing 36,000 DGE of LNG and completing 1,150 vehicle fueling transactions per month. The Perris station, which is expected to be commissioned in the first quarter of 2015, will be a new public access LNG fueling station established at an existing Arco Truck Stop and is expected to have a starting annual throughput of 300,000 DGE.

14219: Upgrade CNG Station at City Yard

Contractor: City of West Covina	SCAQMD Cost-Share	\$ 200,000
	Cosponsors	
	MSRC/AB 2766 Discretionary Fund	300,000
	City of West Covina	118,429
Term: 05/15/14 – 06/15/17	Total Cost:	\$ 618,429

The City of West Covina will upgrade the CNG station located at their West Covina City Yard. Upgrading the system will include the removal of the existing inoperable compressor with duplex compressors and controls, new storage vessels, dispensers and all associated electrical and mechanical equipment. The City has 15 natural gas vehicles, comprised of 13 trucks and vans and

2 buses. Nearby public agencies including several cities and school districts will refuel their natural gas fleets once the station upgrades are complete.

14311: Install & Maintain CNG Fueling Station in Murrieta for SoCalGas

Contractor: Southern California Gas Company	SCAQMD Cost-Share (received as pass-through funds)	\$ 217,000
	Cosponsor	
	Southern California Gas Company	1,168,000
Term: 07/11/14 - 12/31/17	Total Cost:	\$ 1,385,000

The SCAQMD received a CEC grant under AB 118 Program PON-11-602 to assist the Southern California Gas Company to install a new public/private access CNG station located at the Southern California Gas Company facility in Murrieta. This station will be positioned near the junction of the I-15 and I-215 freeways. The station will serve the needs of the SoCalGas’s growing natural gas-powered vehicle fleet as well incentivize local fleets to purchase natural gas powered vehicles, e.g. school districts, water agencies and municipal fleets, as well as provide fueling for vehicles used in goods movement. The facility will include a 600 scfm compressor capable of fueling at 5 GGE/minute as well as 41,000 scf of storage and the public dispenser will include two hoses rated at 3600 psi, a universal card reader and will have 24/7 accessibility.

15438: Refurbish & Upgrade UPS Ontario LCNG Infrastructure

Contractor: United Parcel Service, Inc.	SCAQMD Cost-Share (received as pass-through funds)	\$ 246,707
	Cosponsor	
	United Parcel Service, Inc.	237,828
Term: 12/31/14 – 06/30/18	Total Cost:	\$ 484,535

The United Parcel Service, Inc. (UPS) LCNG station in Ontario, California, was first established in 1997 and continues to provide CNG and LNG refueling to many vehicles, including an expanded fleet of UPS LNG-powered heavy-duty vehicles. The station is located near the Ontario International Airport and is adjacent to both the SR-60 and I-15 freeways, providing a convenient and established source of both CNG and LNG fuel to a wide variety of NGVs and fleets that regularly operate or pass through this region. Nearly 900,000 DGE of LNG and 400,000 DGE CNG are dispensed annually from this facility with demand of both fuel types expected to increase in the near future. SCAQMD applied for and was awarded infrastructure funding through CEC’s AB 118 Program as well as DOE’s Clean Cities Program for this project. The \$96,707 from CEC and \$150,000 from DOE were recognized into the Clean Fuels Fund.

Hydrogen Technology and Infrastructure

13259: Hydrogen Station Operation & Maintenance for Five Cities Hydrogen Program

Contractor: Air Products and Chemicals, Inc.	SCAQMD Cost-Share	\$ 90,000
Term: 03/26/13 – 03/31/15	Total Cost:	\$ 90,000

SCAQMD embarked on an ambitious project to demonstrate hydrogen fueling and hydrogen ICE vehicles throughout the South Coast Air Basin. In 2004, SCAQMD also awarded a contract to Air Products and Chemicals, Inc. (APCI) to build hydrogen stations at the Five Cities sites (Burbank, Ontario, Riverside, Santa Ana and Santa Monica), which included three electrolyzer stations and two mobile fueling stations. The contract for operation and maintenance was extended to March 31, 2015, to provide funding for operation and maintenance of the Riverside, Santa Ana and Santa Monica stations through mid-2014, closing costs for the Ontario station through 2013, and closing and removal of hydrogen fueling equipment at Riverside and Santa Monica in early 2015.

15020: Develop Sampling & Testing Protocols for Analyzing Impurities in Hydrogen

Contractor: University of California Irvine	SCAQMD Cost-Share	\$ 114,500
	Cosponsors	
	AirUCI previously installed analytical instruments	In-kind
Term: 08/13/14 - 04/12/15	Total Cost:	\$ 114,500

Proper codes and standards are essential for the commercial deployment of hydrogen and fuel cell technologies. The SAE J2719 fuel quality standard has been adopted for hydrogen fuel quality; however, testing protocols, along with equipment that can measure hydrogen fuel quality at those levels, need to be assessed. AirUCI will conduct an evaluation of current protocols and propose enhanced protocols as well as develop and implement method(s) to identify and quantify trace contaminants present in hydrogen fuel at hydrogen vehicle fueling stations located within the South Coast Air Basin.

15150: Install or Upgrade Eight Hydrogen Fueling Stations throughout SCAB (including SCAQMD's Diamond Bar Hydrogen Station)

Contractor: Air Products and Chemicals, Inc.	SCAQMD Cost-Share	\$ 1,000,000
	Cosponsors	
	California Energy Commission PON-09-608	11,231,733
	Air Products and Chemicals, Inc.	4,812,483
Term: 10/10/14 - 04/09/19	Total Cost:	\$ 17,044,216

On November 16, 2010, the California Energy Commission released a revised Notice of Proposed Award (NOPA) recommending funding for eight projects that will develop hydrogen fueling infrastructure within the South Coast Air Basin. Additional funds were needed to offset high initial costs and investment for production and distribution of hydrogen for these projects so the SCAQMD stepped in to cost-share these projects. The eight stations are strategically located and will play a significant role by providing hydrogen in Southern California in areas with high vehicle densities. The first station at SCAQMD Headquarters in Diamond Bar will serve as the model for the other modularly constructed delivered-hydrogen stations and will accept major credit cards.

15366: Operate & Maintain Publicly Accessible Hydrogen Fueling Station at SCAQMD Headquarters

Contractor: EPC LLC	SCAQMD Cost-Share	\$ 0
Term: 10/10/14 - 09/14/17	Total Cost:	\$ 0

EPC LLC entered into a license agreement to operate SCAQMD’s new hydrogen fueling station in Diamond Bar. The license allows EPC to assign or sublet with SCAQMD’s written permission; Air Products and Chemicals, Inc. will be providing equipment maintenance under their contract #15150 in coordination with EPC. EPC LLC obtained all permits for construction, maintenance and operation and will be operating the station for three years, including installation and operation of the point-of-sale (POS) credit card system.

15419: Disposition of Dispenser from Electrolyzer Hydrogen Station Demonstration at SCAQMD Headquarters

Contractor: SunLine Transit Agency	SCAQMD Cost-Share	\$ 0
	Cosponsor	
	Sunline Transit Agency	In-kind
Term: 12/24/14 - 12/23/15	Total Cost:	\$ 0

At the end of the useful life of the original Stuart Energy electrolysis-generated hydrogen fueling station at SCAQMD, Hydrogenics decommissioned the station and removed all the obsolete equipment under contract #10061. SunLine Transit has the only known remaining identical FTI hydrogen dispenser in our region at their hydrogen fueling station and it requires spare parts in order to continue operation until their station can be upgraded. SunLine Transit agreed to indemnify SCAQMD and provided labor and equipment to relocate the dispenser to their station.

Direct Payment: Conduct Hydrogen Quality Sampling & Analysis at Three Hydrogen Stations (Diamond Bar, Burbank and Newport Beach)

Contractor: Smart Chemistry Corporation	SCAQMD Cost-Share	\$ 10,350
Term: 11/19/13 – 01/19/14	Total Cost:	\$ 10,350

The SCAQMD maintains a hydrogen station at its Headquarters in Diamond Bar, and every few years there is a need to conduct sampling and analysis of particulates and gaseous content in the hydrogen fuel. Smart Chemistry is one of the few qualified independent laboratories that can perform sampling and analysis of hydrogen gas streams to the low levels SAE J2719. Smart Chemistry first assisted SCAQMD back in 2008 with performing gas sampling and chemical analysis of the electrolyzer-based hydrogen fueling station. Additionally, in 2014 the SCAQMD also tasked Smart Chemistry with sampling and analysis at the Newport Beach and Burbank hydrogen stations, which are scheduled for upgrades to begin retail sales of hydrogen sometime in 2015-16. The work conducted was for determining hydrogen purity in order to present to the various OEMs assuring them the quality met the SAE J2719 standards.

Direct Pay: Additional Support for California Fuel Cell Partnership's Hydrogen Fueling Activities

Contractor: Hydrogen Fueling Station	SCAQMD Cost-Share	\$ 10,000
	Cosponsors	
	Several automotive and government members	117,000
Term: 01/01/14 - 06/04/14	Total Cost:	\$ 127,000

The successful passage of AB 8, which dedicates funding for hydrogen infrastructure, was the result of the efforts of many entities including outreach ride-and-drive activities by CaFCP staff and member organizations. This additional support will continue to provide hydrogen fueling for CaFCP outreach activities until the new West Sacramento and SCAQMD hydrogen fueling stations are operational.

Purchase Order: Purchase FTIR to Perform Hydrogen Fuel Quality Testing

Contractor: MKS Instruments	SCAQMD Cost-Share	\$ 91,768
Term: 08/07/14 – 01/23/15	Total Cost:	\$ 91,768

Proper codes and standards are essential for the commercial deployment of hydrogen and fuel cell technologies. The SAE J2719 fuel quality standard has been adopted for hydrogen fuel quality; however, testing protocols, along with equipment that can measure hydrogen fuel quality at those levels, need to be assessed. The fuel quality required by SAE J2719 must be quantified at the vehicle-fueling station interface and a determination made as to how the presence of small amounts of contaminants may affect the performance and durability of proton exchange membrane (PEM) fuel cells. Current analyses of hydrogen fuel quality have to be enhanced or developed for approximately half of the fuel cell specifications. SCAQMD laboratory staff have investigated the applicability of various instruments and determined a purpose-designed FTIR gas analyzer for measuring certain contaminants within hydrogen fuel would be most cost-efficient. The equipment cost includes software, operational calibration recipes and training. A significant cost savings is realized by the purchase of this equipment. If this equipment were not acquired, separate analyses would have to be developed for sampling of acid halides (no known method for halogens such as chlorine or bromine), formaldehyde (HPLC analysis for formaldehyde at four hours per sample), and ammonia (impinger sampling and IC analysis for ammonia at four hours). Halogen gas sampling and analysis has yet to be scoped. This equipment will act as the cornerstone for analyzing hydrogen fuel purity.

Mobile Fuel Cell Technologies

14622: CSULB CEERS Student Education Project to Demonstrate Graphene Fuel Cell Catalysts

Contractor: California State University Long Beach Foundation	SCAQMD Cost-Share	\$ 28,000
Term: 08/05/14 – 05/31/15	Total Cost:	\$ 28,000

The Center for Energy and Environmental Research and Services (CEERS) at the California State University Long Beach (CSULB) proposed conducting a feasibility study

of iodine-edged graphene catalysts for Proton Exchange Membrane Fuel Cell (PEMFC). The goal is to obtain the performance of these catalysts under operating fuel cell conditions and to understand how these catalysts have improved properties versus traditional Platinum (Pt) catalysts. The motivation for this study was to find an ideal catalyst that is dramatically less expensive and has improved durability and performance than pure Pt for PEMFC.

15388: Participate in California Fuel Cell Partnership for CY 2014 & Provide Support for Regional Coordinator

Contractor: Bevilacqua-Knight, Inc.	SCAQMD Cost-Share	\$ 137,800
	Cosponsors	
	8 automakers; 5 government agencies; 1 fuel cell provider, and 9 associate and 14 affiliate members	1,927,200
Term: 01/01/14 - 12/31/14	Total Cost:	\$ 2,065,000

In April 1999, the California Fuel Cell Partnership (CaFCP) was formed with eight members; SCAQMD joined and has participated since 2000. The CaFCP and its members are demonstrating and deploying fuel cell passenger cars and transit buses with associated hydrogen fueling infrastructure in California. Since the CaFCP is a voluntary collaboration, each participant contracts with Bevilacqua-Knight, Inc. (BK) for their portion of the CaFCP’s administration. In 2014, the SCAQMD Board contributed \$87,800 for membership and up to \$50,000, along with four cubicles at SCAQMD Headquarters, to provide support for the CaFCP Regional Coordinator.

Health Impacts Studies

12865: Develop Quantitative Cellular Assays for Use in Understanding the Chemical Basis of Air Pollutant Toxicity

Contractor: University of California Los Angeles (UCLA)	SCAQMD Cost-Share	\$ 319,553
Term: 06/08/12 – 07/31/15	Total Cost:	\$ 319,553

The objective of this research is to develop a biological mechanism-based analytical procedure to characterize the toxicity air pollutants. The study is developing and characterizing a standard in quantities sufficient to be employed in subsequent toxicity analyses of vehicle emissions and ambient pollutants. UCLA is working with researchers at the University of California Riverside Center for Environmental Research and Technology (UCR/CE-CERT) to collect a large quantity of diesel exhaust, including both particulate and vapor phase, from a well-characterized engine using low-sulfur fuel as the standard. Quantitative dose response toxicity assays can then be conducted with, for example, emissions from advanced technology engines to compare with results from assays using the standard diesel emissions. This will provide a measure of the relative toxic potency of vehicle emissions that can be directly compared in standard assays.

14171: Risk of Incident Asthma among Children from in-Utero Exposures to Traffic Related Pollutants

Contractor: Southern California Research Center/Allergy & Asthma Associates of Southern California	SCAQMD Cost-Share	\$ 99,670
	Cosponsor	
	BP	217,449
Term: 09/22/14 – 03/21/16	Total Cost:	\$ 317,119

This project will estimate the association of traffic exposure during pregnancy and diagnosis of asthma during childhood. This study is among the first to evaluate potential risk of exposures near the residence, work, and in-vehicle travel during a vulnerable time of immune system development. The project uses a case control study design. The subjects with asthma are recruited from patients in a large medical practice focusing on asthma. Historical data are available including date of birth, residence history, demographic variable, and asthma severity and control. Control subjects matched for characteristics such as age, gender and ethnicity are being recruited from general pediatric clinics, preschools and other venues. The goal is to recruit 1,000 cases and an equal number of matched controls. Traffic-related exposures during pregnancy are estimated based on residence and work locations and on commute patterns. Markers of traffic emissions include NO, NO₂, CO, PM_{2.5} and ultrafine particles. Both dispersion models of nearby traffic emissions as well as regional air monitoring data will be employed. Additionally, a model developed under a previous research project will be used to estimate exposures to traffic pollutants during commuting times.

14172: The Relation of Airway & Systemic Oxidative Stress to Particulate Air Pollution Exposures in an Elderly Cohort

Contractor: University of California Irvine	SCAQMD Cost-Share	\$ 159,974
	Cosponsor	
	BP	216,394
Term: 02/17/14 – 08/16/15	Total Cost:	\$ 376,368

This project will be accomplished in coordination with a study funded by the National Institutes of Health on the health effects of fine particulate exposures. It includes weekly measurements of air pollutants and cardiovascular and respiratory symptoms in a group of 120 elderly subjects living in the South Coast Air Basin. Half of the subjects reside in Los Angeles, and half reside in Anaheim. The measurements are taken over two six-week periods, one in the cool season and one in the warm season. The current project adds measures for markers of oxidative stress in the breath and in the blood of the subjects. About half of the subject data have been collected during the first year of the project. The analysis will determine which pollutants are associated with specific respiratory and cardiovascular health outcomes. It is hypothesized that oxidant pollutants, such as ozone and secondary organic aerosols, which include oxidized organic substances emitted from fuel combustion associated with particulate matter, are responsible for respiratory effects. It is further hypothesized that cardiovascular effects and changes in blood markers are associated with freshly emitted traffic-related organic chemicals in particulate matter.

Fuels/Emissions Studies

13402: Next Sustainable Transportation Energy Pathways (STEPS) Program

Contractor: University of California Davis-Office of Research	SCAQMD Cost-Share	\$ 120,000
	Cosponsors	
Term: 05/02/14 - 07/01/16	Total Cost:	\$ 2,760,000

13402: Next Sustainable Transportation Energy Pathways (STEPS) Program

Contractor: University of California Davis/Institute of Transportation Studies	SCAQMD Cost-Share	\$ 120,000
	Cosponsors	
	20 organizations from energy, automotive, and government sectors	2,640,000
Term: 05/02/14 - 07/01/16	Total Cost:	2,760,000

The University of California Davis/Institute of Transportation Studies is continuing a multi-year Next Sustainable Transportation Energy Pathways (NextSTEPS) Program to develop the theory, tools and methods for self-consistent and transparent comparisons of promising alternative energy and vehicle pathways, and to apply these tools and methods in comparative assessments of transportation energy pathways. Increased analysis of shale oil and gas will be added and models for hydrogen, electricity and biofuels will be further refined. SCAQMD identified four key subject areas for inclusion in this multi-year program: 1) Transition Scenarios for Alternative Fuels and Vehicles in California; 2) Consumer Behavior and Vehicle Choice: Longitudinal Tracking; 3) Best Policy and Incentive Strategies; and 4) Low Carbon Options for Non Light-Duty Subsectors.

14162: Utilization of Fleet DNA Approach and Capabilities to Provide Vehicle Vocational Analysis in SCAQMD

Contractor: National Renewable Energy Laboratory	SCAQMD Cost-Share	\$ 174,985
	Cosponsor	
	National Renewable Energy Laboratory	25,000
Term: 02/26/14 – 12/30/15	Total Cost:	\$ 199,985

The National Renewable Energy Laboratory (NREL) is collecting and analyzing data in the SCAQMD's jurisdiction to match powertrains and advanced technology with duty cycles of medium- and heavy-duty trucks. Vehicle duty cycle data will be collected from specific fleet vocations, chosen primarily by their contribution to the medium- and heavy-duty vehicle

emissions inventory. This study will provide information to optimize deployment of advanced vehicle technology in order to maximize emission reductions and fuel economy.

Outreach and Technology Transfer

12376: Technical Assistance with Alternative Fuels, Biofuels, Emissions Testing & Zero-Emission Transportation Technology

Contractor: University of California Riverside/CE-CERT	SCAQMD Cost-Share	\$ 75,000
Term: 06/13/14 – 05/31/16	Total Cost:	\$ 75,000

SCAQMD seeks to implement aggressive programs to develop and demonstrate pre-commercial technologies for low- and zero-emission vehicles and equipment, alternative fuels, and renewable energy sources. Due to constant and rapid changes in technologies and the sheer breadth of potential projects, SCAQMD supplements in-house technical resources with outside expertise and assistance to evaluate and implement these demonstration projects. The College of Engineering/Center for Environmental Research and Technology (CE-CERT) is a research center at University of California Riverside dedicated to research on air quality and energy efficiency with approximately 120 investigators including 30 Ph.D. level researchers. CE-CERT will provide technical expertise to evaluate a broad range of emerging technologies in alternative and/or renewable fuels and vehicles as well as to conduct air pollution formation and control studies.

12381: Technical Assistance with Alternative Fuels, Fuel Cells, Emissions Analysis & Aftertreatment Technologies

Contractor: Integra Environmental Consulting Inc.	SCAQMD Cost-Share	\$ 75,000
Term: 06/21/12 – 05/31/16	Total Cost:	\$ 75,000

External expertise is needed to augment in-house expertise and assist staff in technical reviews of emission inventories, goods movement and off-road sources. Integra Environmental Consulting, Inc. was selected to provide technical assistance with emission inventories, goods movement sector analysis and off-road sources, especially related to availability and commercialization of near-zero and zero emission vehicles and equipment.

13194: Technical Assistance with Alternative Fuels, Renewable Energy & EVs, Program Related Activities for AFVs, Lawn Mower Exchange, Conferences & Outreach

Contractor: Clean Fuel Connection, Inc.	SCAQMD Cost-Share	\$ 50,000
Term: 12/07/12 – 06/30/15	Total Cost:	\$ 50,000

SCAQMD relies on expert input, consultation and support to manage a number of programs conducted under the Clean Fuels Program and incentive programs. Clean Fuel Connection, Inc. (CFCI) is providing technical assistance with alternative fuels, renewable energy and electric vehicles to promote, assess, expedite and deploy the development and demonstration of advanced, low- and zero-emissions mobile and stationary technologies. This modification to

increase available funds under this existing Contract is for administrative support to enable the range of activities involved in implementing the Clean Fuels Program and associated complimentary programs as needed. Support is necessary to enhance or expand existing program-related activities associated with performing or meeting program objectives such as alternative fuel vehicles (AFVs) demonstration programs, the lawn mower exchange program, participation in technical conferences and other outreach activities.

14185: Conduct Education Outreach for the Basin DC Fast Charging Network Project

Contractor: Three Squares, Inc.	SCAQMD Cost-Share	\$ 49,183
Term: 04/11/14 – 10/31/16	Total Cost:	\$ 49,183

Three Squares, Inc. (TSI) was selected to conduct education outreach for the DC fast charging network as each of the 26 sites were installed. TSI is an environmental consulting firm with extensive experience working with advanced technology, vehicle manufacturers and emission control technology providers. Education outreach components and social media campaign for users of the DC fast charging network will include information on the benefits of driving plug-in electric vehicles (PEVs) and having public fast charging in their communities, how to use DC fast chargers, and a list of available incentives for PEVs and infrastructure. Sites will be installed in 2015 and completed in early 2016. TSI will also produce a best practices guidelines document on education outreach and messaging, based on survey data and web traffic from network users.

15344: Technical Assistance with Alternative Fuels, Electric Vehicles, Charging and Fueling Infrastructure and Renewable Energy

Contractor: Clean Fuel Connection, Inc.	SCAQMD Cost-Share	\$ 60,000
Term: 09/22/14 – 09/22/16	Total Cost:	\$ 60,000

Clean Fuel Connection, Inc. (CFCI) will provide technical and administrative support for development and demonstration of advanced, low- and zero-emission mobile and stationary technologies for the Clean Fuels Program and various complementary incentive programs. CFCI's technical expertise and support enhances existing program-related activities associated with performing or meeting program objectives.

15369: Technical Assistance with Low- and Zero-Emission Vehicles, Fuel Cells, Stationary Applications and Emissions Analyses

Contractor: Breakthrough Technologies Institute, Inc.	SCAQMD Cost-Share	\$ 30,000
Term: 11/07/14 – 11/06/16	Total Cost:	\$ 30,000

At its December 6, 2013 meeting, the Board approved RFP #P2014-10 to solicit proposals for technical assistance for the Clean Fuels Program and implementation of various incentive funding programs. The RFP solicited statements of qualifications from individuals and organizations potentially capable of providing technical assistance in a variety of areas to support staff activities. The RFP sought companies or individuals to provide assistance in preparation of AQMP control measures; assessment of zero-emission and goods movement technologies; technical assistance for feasibility studies of stationary and mobile emission control technologies;

emissions assessment of new alternative fuel technologies; evaluation of innovative emissions control systems; assessment of economic, regulatory and technical barriers to the commercialization of clean fuels and advanced technologies; and to implement various incentive programs. Contracts with five technical experts including Breakthrough Technologies Institute were executed to provide technical assistance and outreach support. Breakthrough Technologies Institute is providing technical assistance with low- and zero-emission vehicles, fuel cells, stationary applications and emissions analyses. The team at Breakthrough Technologies Institute has a combined professional experience and proven expertise of over 80 years in the areas of alternative fuels, low- and zero-emission technologies, emission controls and federal policies and state regulations.

15380: Technical Assistance with Goods Movement, Alternative Fuels and Zero-Emission Transportation Technologies

Contractor: ICF Resources LLC	SCAQMD Cost-Share	\$ 30,000
Term: 12/12/14 – 12/11/16	Total Cost:	\$ 30,000

This contract is one of the five technical experts awarded funding as a result of RFP #P2014-10 which solicited proposals for technical assistance for the Clean Fuels Program and implementation of various incentive funding programs. ICF International is providing technical assistance with goods movement technologies, alternative fuels and zero-emission transportation technologies. ICF is a leading technology firm with over 40 years of experience. ICF has worked as a prime contractor for local, state and federal agencies and has extensive expertise in the areas of fuels and transportation related issues.

15415: Technical Assistance with Alternative Fuels and Fueling Infrastructure, Emissions Analysis and On-Road Sources

Contractor: Gladstein, Neandross & Associates, LLC	SCAQMD Cost-Share	\$ 60,000
Term: 11/07/14 – 11/06/16	Total Cost:	\$ 60,000

This contract is another one of the five technical experts awarded funding as a result of RFP #P2014-10 which solicited proposals for technical assistance for the Clean Fuels Program and implementation of various incentive funding programs. Gladstein, Neandross & Associates, LLC (GNA) is providing technical expertise with alternative fuels and fueling infrastructure, emission analysis and on-road sources. GNA has partnered with energy, transit, waste management and goods movement companies to develop projects such as the use of LNG in cargo handling equipment at the Ports of Los Angeles and Long Beach, evaluation of the feasibility of utilizing LNG in the Ports' yard equipment and the development of strategies to reduce emissions from construction and operations of the proposed LNG import terminal.

Transfer: Participate in California Natural Gas Vehicle Partnership

Contractor: Transfer from Clean Fuels	SCAQMD Cost-Share	\$ 25,000
	Cosponsors	
	CNGVP Participating Members	135,000
Term: 07/11/14 – 07/11/14	Total Cost	\$ 160,000

The California Natural Gas Vehicle Partnership (CNGVP) was formed to accelerate the development of advanced natural gas vehicle technologies to provide a benchmark for lowering emissions from petroleum-based engines and to provide a pathway to future fuel cell use in the next two decades. The SCAQMD spearheaded the formation of this strategic alliance, which comprises state and federal air quality, transportation and energy agencies, vehicle and engine manufacturers, fuel providers, and transit and refuse hauler organizations. Partnership Steering Committee members contribute monies to fund specific projects intended to achieve the goal of the Partnership. In July 2014 the SCAQMD approved \$25,000 for the SCAQMD’s participation in the Steering Committee for the next two years.

Direct Pay: Technical Assistance for EV Charging Infrastructure Grant Preparation

Contractor: Three Squares, Inc.	SCAQMD Cost-Share	\$ 15,306
Term: 01/01/14 – 02/06/14	Total Cost	\$ 15,306

CEC released PON-13-606 offering funding for EV charging infrastructure, with projects due by February 4, 2014. SCAQMD retained the expertise of Three Squares, Inc. to provide technical assistance in developing, preparing and submitting a grant proposal to expand the South Coast Air Basin DC Fast Charging Network. Three Squares, Inc. worked with staff on writing the project narrative, gathering the required CEQA and health impacts documentation and site selection. On July 3, 2014, CEC issued a NOPA announcing the SCAQMD had been awarded \$500,000 to implement six additional sites to their DC fast charging network. CEC later agreed to award an additional \$420,000 to their original grant for the first 20 DC fast charging sites for a revised award of \$720,000. Total CEC funding for the 26-site network is \$1.22 million.

Direct Pay: Participation for CY 2014 Membership in Transportation Research Board and Support of Minority Student Fellows Program

Contractor: Transportation Research Board	SCAQMD Cost-Share	\$ 36,500
	Cosponsors	
	SCAQMD’s Legislative & Public Affairs Office	32,500
	Core Program Participating Members	191,000
Term: 01/01/14 – 12/31/14	Total Cost	\$ 260,000

In 2014 the SCAQMD supported the Transportation Research Board (TRB) by participating as a member and sponsoring TRB’s 2014 Minority Student Fellowship Program. The mission of the TRB is to promote innovation and progress in transportation through research. In an objective and interdisciplinary setting, TRB facilitates the sharing of information on transportation practice and policy by researchers and practitioners; stimulates research and offers research management services that promote technical excellence; provides expert advice on transportation policy and programs; and disseminates research results broadly and encourages their implementation. TRB’s varied activities annually engage more than 7,000 engineers, scientists, and other transportation researchers and practitioners from the public and private sectors and academia, all of whom contribute their expertise in the public interest by participating on TRB committees, panels and task forces. TRB is one of six major divisions of the National Research Council (NRC) - a

private, nonprofit institution that is jointly administered by the National Academy of Sciences, the National Academy of Engineering and the Institute of Medicine - and is the principal operating agency of the National Academies in providing services to the government, the public and the scientific and engineering communities. The TRB Executive Committee, whose members are appointed by the chairman of NRC, exercises oversight responsibility for the Board's programs and activities. Members include senior transportation industry executives, top officials of public-sector transportation agencies, and distinguished researchers from academia. Sponsors and affiliates provide support for TRB core programs and activities. Sponsors are the major source of financial support for TRB's core technical activities. Federal, state, and local government agencies and professional societies and organizations that represent industry groups are eligible to be TRB sponsors. TRB's annual expenditures for program activities exceed \$90 million.

Direct Pay: Cosponsor 22 Conferences, Workshops & Events plus 5 Memberships

Contractor: Various	SCAQMD Cost-Share	\$ 294,038
	Cosponsors	
	Various	5,168,895
Term: 01/01/14 – 12/31/14	Total Cost	\$ 5,462,933

The SCAQMD regularly participates in and hosts or cosponsors conferences, workshops and events. These funds provide support for the 22 conferences, workshops and events sponsored throughout 2014 as follows: NAFTA NEXT Summit in April; Coordinating Research Council's 2014 Vehicle Emissions Workshop in March; UCR's 2014 Solar Energy Conference in February and 2014 PEMS Conference in April; UCI's ICEPAG 2014 in April; California Science Center Foundation's Foundation Fair Awards in April; JLP's 2014 Climate Day; EPRI's 2014 Plug-In Conference in July; The Women in Green Forum in August; CleanTechOC's 2014 Symposium: Stepping on the Gas in June; 2014 ACT Expo in Long Beach in May as well as a booth at the ACT Expo; the 7th Symposium on Global Emerging Environmental Challenges and Government in July; U.S. EPA's West Coast Collaborative Meeting in San Francisco in September; the 2014 Santa Monica AltCar Expo in August; 2014 GloSho in September; the Southern California Energy Summit in Palm Springs in October; CleanTechOC's 2014 Conference & Expo in October; the 2014 LA Auto Show, the Fuel Cell Seminar in November; Calstart's 2014 Annual Meeting & Blue Sky Awards in November; and Clean Fuel Advisory Group Participation Fees for February and August retreats. Additionally, for 2014 five memberships were renewed for participation in the PEV Collaborative, the Fuel Cell & Hydrogen Energy Association, the California Hydrogen Business Council, the Electric Drive Transportation Association, and the Air & Waste Management Association.

PROGRESS AND RESULTS IN 2014

Key Projects Completed

A large number of emission sources contribute to the air quality problems in the South Coast Air Basin. Given the diversity of these sources, there is no single technology or “silver bullet” that can solve all of the region’s problems. Accordingly, the SCAQMD continues to support a wide range of advanced technologies, addressing not only the diversity of emissions sources, but also the time frame to commercialization of these technologies. Projects co-funded by the SCAQMD’s Clean Fuels Program include emission reduction demonstrations for both mobile and stationary sources, although legislative requirements limit the use of available funds primarily to on-road mobile sources.

Historically, mobile source projects have targeted low-emission technology developments in automobiles, transit buses, medium- and heavy-duty trucks and off-road applications. These vehicle-related efforts have focused on: 1) advancements in engine design, electric power trains, energy storage/conversion devices (e.g., fuel cells and batteries); and 2) implementation of clean fuels (e.g. natural gas, propane and hydrogen) including their infrastructures. Stationary source projects have included a wide array of advanced low NO_x technologies and clean energy alternatives, such as fuel cells, solar power and other renewable energy systems.

Table 5 (page 61) provides a list of 46 projects and contracts completed in 2014. Summaries of the completed technical projects are included in Appendix C. Selected projects which represent a range of key technologies from near-term to long-term are highlighted below.

Demonstrate Battery Electric Heavy-Duty Trucks

CARB classified diesel exhaust as a known carcinogen in 1990 and as a toxic air contaminant in 1998, and the ports at Los Angeles and Long Beach are implementing measures to combat diesel emissions from goods movement activities. One of the major sources of criteria pollutant emissions is from diesel-fueled heavy-duty trucks. There are several measures that can be used to reduce emissions from heavy-duty trucks, such as conversion to clean fuels, hybridization and electrification. The Battery Electric Heavy-Duty Trucks project is an example of how the electrification of a drayage truck to reduce emissions from diesel-fueled trucks was accomplished.

A zero emission battery-electric drive system was installed by TransPower into two Class 8 truck tractors. Each drive system was intended to utilize network control architecture to control modular components, including high-power drive motors and inverters along with electrically-driven accessories, powered by lithium battery packs. A key technology advancement enabled by this project was development of a new onboard inverter-charger unit (ICU), which combines the functions of a motor inverter and battery charger. Other key advances included application of a new automated manual transmission and advanced battery management technologies to Class 8 electric trucks.

The ElecTruck project was highly successful in its core long term



Figure 18: Truck #2 with loaded container provided by Port of LA

objectives of achieving major technology advances in two key areas: (1) vehicle control and integration and (2) advanced energy storage. More generally, the ElecTruck project successfully advanced the state of the art in application of electric propulsion technology to Class 8 trucks, and provided valuable lessons learned that enabled TransPower to proceed to even more advanced component and integrated subsystem designs that are being incorporated into a growing fleet of fully operational electric Class 8 trucks, tractors and school buses. These vehicles are exhibiting performance characteristics beyond those of any other electric vehicles of this class.

The ElecTruck project demonstrated the essential feasibility of eliminating emissions from the largest and most polluting road vehicles - Class 8 trucks. If 5,000 electric trucks of the ElecTruck design were deployed in California by 2020, this would achieve an estimated aggregate emissions reduction of 378,500 tons of carbon per year – a significant step toward achieving the CARB 2020 limit of 427 million tons. Electric trucks of this design also eliminate criteria pollutants at the point of operation and reduce noise. By eliminating use of fossil fuels, they are also less expensive to operate and reduce our dependence on imported oil.

Sources, Composition, Variability and Toxicological Characteristics of Ultrafine Particles in Southern California

Many of the health effects associated with exposure to particulate matter (PM) derive from the ability of PM to generate oxidative stress. There is evidence that ultrafine particles (UFP) (with diameters of $< 0.1- 0.2 \mu\text{m}$), in particular, may be more toxic than coarse or fine PM. Despite their very low contribution to PM mass, UFP dominate particle number concentrations as well as have a large surface area relative to fine or coarse particles and a high pulmonary deposition efficiency. These particles can thus carry considerable amounts of toxic air pollutants, such as organic carbon and transition metals.

This project involved collecting samples of quasi-ultrafine particles ($\text{PM}_{0.25}$, $\text{dp} < 0.25 \mu\text{m}$) over a year's time at several locations in the South Coast Air Basin. Sites included source, near-freeway, semi-rural receptor and desert locations. Twenty-four hour time-integrated samples were concurrently collected once a week for a year-long period at 10 distinctly different areas across the Los Angeles Basin, followed by comprehensive chemical and toxicological analyses, to provide insight on the seasonal and spatial variability in the chemical composition, sources and oxidative potential. The sampling site locations are shown in the following figure.

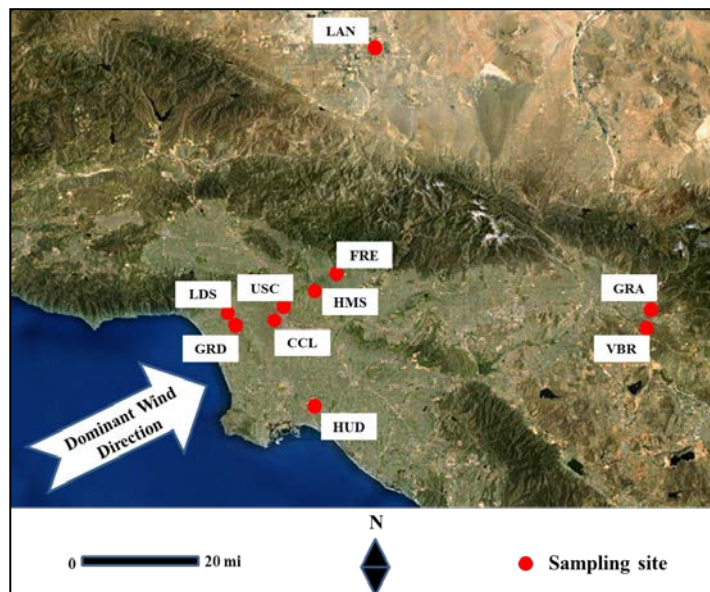

Figure 19: Location of the sampling sites

Average PM_{0.25} mass concentration ranged from 5.9 to 16.1 $\mu\text{g}/\text{m}^3$ across the basin and seasons. Wintertime levels were highest at the source HUD site, while lowest at the desert-like LAN site. On the other hand, summertime concentrations peaked at the inland receptor locations. Chemical mass closure showed that that quasi-UFP in the basin consisted of 49–64% organic matter, 3–6.4% elemental carbon (EC), 9–15% secondary ions (SI), 0.7–1.3% trace ions, and 5.7–17% crustal material and trace elements, on a yearly average basis. Seasonal variation in source apportionment of quasi-ultrafine particles by site is show in the figure below.

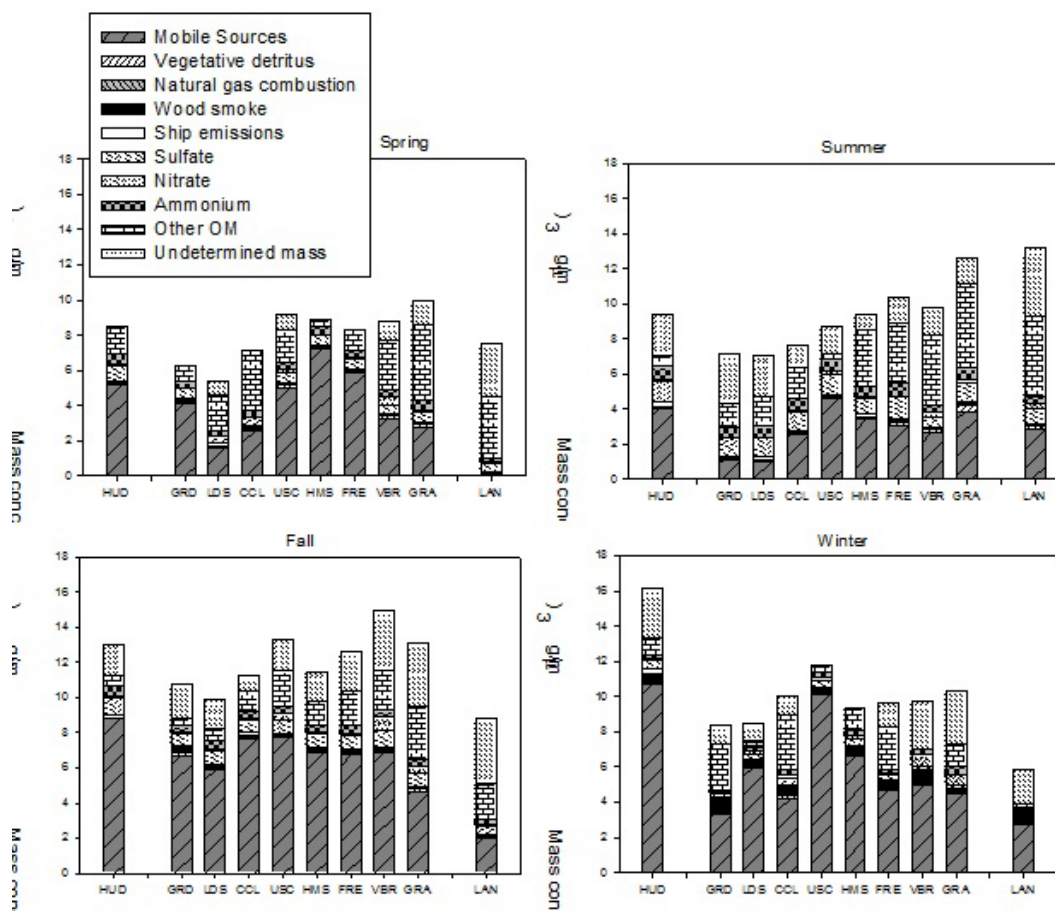

Figure 20: Seasonal variation in source apportionment of quasi-ultrafine particles ($dp < 0.25 \mu\text{m}$) by site

The redox activity (which is thought to be related to potential toxicity) of PM_{0.25} samples was also assessed by means of a biological reactive oxygen species (ROS) assay (generation of ROS in rat alveolar macrophage cells). Seasonally, fall and summer displayed higher volume-based ROS-activity (i.e. ROS-activity per unit volume of air) compared to spring and winter. ROS levels were generally higher at near source and urban background sites compared to rural receptor locations, except for summer when comparable ROS-activity was observed at the rural receptor sites. Mass-based ROS activity, which reflects the intrinsic toxicity of particles, showed very similar trends to volume-based ROS activity, indicating that PM composition, more than PM mass concentration, was driving ROS activity. Variation in mass-based ROS Activity (μg Zymosan/mg PM) at different sampling sites are show below.

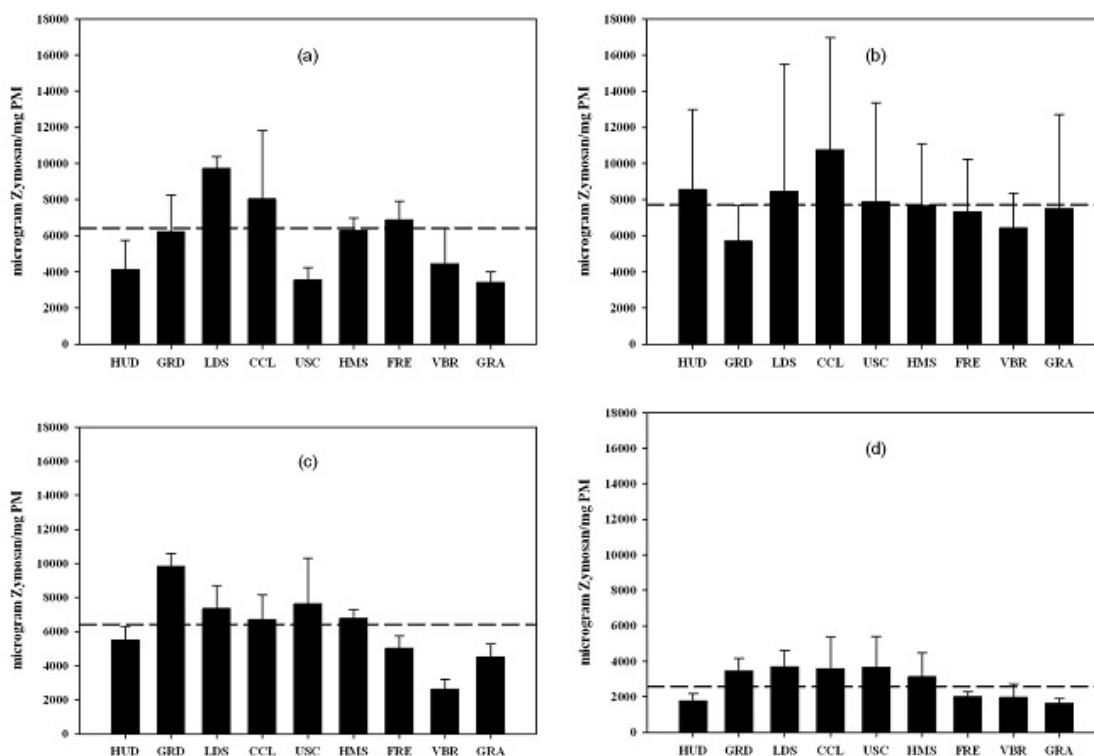

Figure 21: Variation in mass-based ROS Activity (ug Zymosan/mg PM) at different sampling sites during: (a) spring, (b) summer, (c) fall and (d) winter. Error bars correspond to one standard deviation. Dashed lines indicate the average of 9 sampling sites

These findings help establish the association between sources, composition and toxicity of UFP and provide a strong scientific basis for developing more targeted and cost-effective regulatory strategies at both the federal and state level. Moreover, the extensive database on UFP, generated from this project, constitutes an invaluable resource to PM exposure and health studies in the South Coast.

Publications:

A. Saffari, N. Daher, M. M. Shafer, J.J. Schauer, C. Sioutas. Seasonal and spatial variation in dithiothreitol (DTT) activity of quasi-ultrafine particles in the Los Angeles Basin and its association with chemical species. *Journal of Environmental Science and Health, Part A: Toxic/Hazardous Substances and Environmental Engineering*, 49 (4), 441-451, 2014

A. Saffari, N. Daher, M. M. Shafer, J.J. Schauer, C. Sioutas. Global perspective on the oxidative potential of airborne particulate matter: a synthesis of research findings. *Environmental science and technology*, 2014, 48, 7576-7583.

A. Saffari., N. Daher, M. M. Shafer, J.J. Schauer, C. Sioutas. Seasonal and spatial variation of trace elements and metals in quasi-ultrafine (PM_{0.25}) particles in the Los Angeles metropolitan area and characterization of their sources. *Environmental Pollution*, 181, 14-23, 2013.

A. Saffari, N. Daher, M. M. Shafer, J.J. Schauer, C. Sioutas. Seasonal and spatial variation in reactive oxygen species activity of quasi-ultrafine particles (PM_{0.25}) in the Los Angeles metropolitan area and its association with chemical composition. *Atmospheric Environment*, 79, 566-575, 2013.

D. Wang, P. Pakbin, M. M. Shafer, D. Antkiewicz, J. J. Schauer and C. Sioutas. Macrophage Reactive Oxygen Species Activity of Water-soluble and Water-insoluble Fractions of Ambient Coarse, PM_{2.5} and Ultrafine Particulate Matter (PM) in Los Angeles. *Atmospheric Environment*, 77, 301-310, 2013.

S. Hasheminassab, N. Daher, J.J. Schauer, C. Sioutas. Source apportionment and organic compound characterization of ambient ultrafine particulate matter (PM) in the Los Angeles Basin. *Atmospheric Environment*, 79, 529-539, 2013.

N. Daher, S. Hasheminassab, M.M. Shafer, J.J. Schauer, C. Sioutas. Seasonal and spatial variability in chemical composition and mass closure of ambient ultrafine particles in the megacity of Los Angeles. *Environmental Science: Processes and Impacts*, 15, 283-295, 2013.

Conversion of Biowaste to Natural Gas using Steam Hydrogasification

Utilization of renewable energy sources is an integral part of California's strategy to reduce greenhouse gas emissions and to diversify domestic energy sources. Renewable Natural Gas (RNG) can be produced from carbonaceous and renewable feedstocks through a number of technologies including anaerobic digestion, gasification and pyrolysis. However, these technologies are often inefficient and the product gas is typically of low quality and inferior to fossil source-based natural gas. The Steam Hydrogasification Reaction (SHR), developed by the University of California Riverside/CE-CERT, is a thermo-chemical process that can produce high quality RNG from organic waste in a cost-effective and efficient manner. The SHR is also capable of handling wet feedstock providing an attractive alternative to landfilling solid wastes with high moisture contents like wastewater sludge that can pose more environmental issues in disposal. Another key benefit of this process is it uses steam to significantly increase the methane formation rate with a high carbon conversion efficiency compared to other gasification technologies. In addition, the SHR does not require an expensive oxygen plant that can be a significant barrier for smaller-scale production facilities.

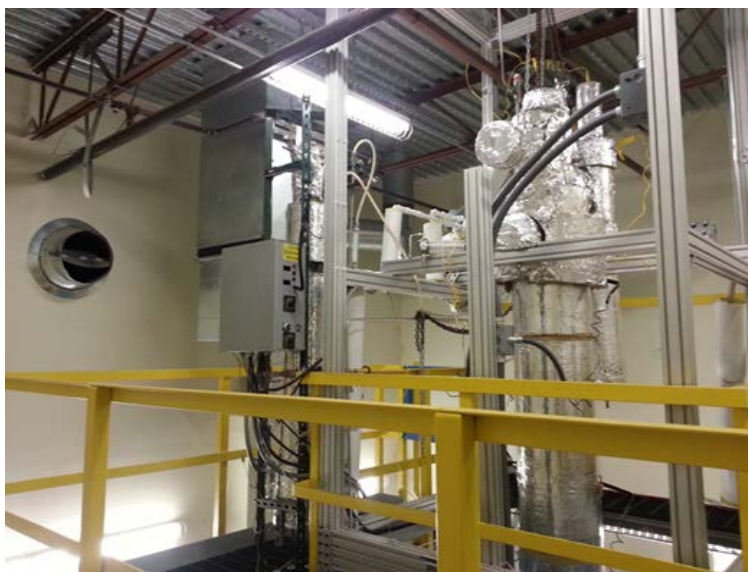

Figure 22: PDU SHR-WGS system

The objective of this project was to demonstrate the SHR system in a Process Development Unit (PDU) scale reactor to produce RNG from organic waste in order to validate and optimize the process for a pilot plant design. A bubbling fluidized bed SHR with a 5 lb/hr feed rate was used in this project with a water gas shift (WGS) reactor integrated to maximize the methane production. As illustrated in Figure 42, biosolids comingled with food and green waste were pretreated in a hydrothermal reactor to pumpable slurry and fed into the SHR. When the slurry reached the

reaction zone, it reacted with hydrogen and water producing methane, CO and CO₂. With solid particles and moisture removed through a gas clean-up process, the product gas then passed through the WGS to convert CO into hydrogen and CO₂. In this project, a gas recirculation loop was added to recycle internally generated hydrogen back to the reactor for a self-sustained operation without external hydrogen supply.

The demonstration yielded a final gas composition of 73% CH₄ and 27% CO after CO₂ separation. In addition, an ASPEN modeling study showed that the methane concentration can be further increased to 90% by utilizing CO in the methanation process. Carbon conversion efficiency was 75% meaning 75% of carbon in the feedstock was utilized to produce the

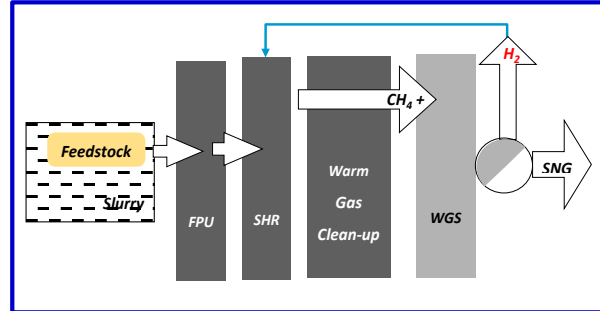

Figure 23: SHR-WGS Process Diagram

product gas. The remaining 25% was converted into char that can be utilized as fuel for heat source in a larger scale demonstration. Through this project, the process condition was optimized as follows: 1.0 H₂/C mole ratio, 1.5 H₂O/feedstock mass ratio, 750oC reactor temperature, 400 Psia reactor pressure, and 320-380oC WGS operation temperature. In addition, an economic analysis for a commercial-scale plant showed that the RNG production cost will range from \$5 to \$15/MMBtu depending on site capacity and applications.

Biofuels derived from waste-based feedstocks typically have lower carbon intensities compared to other biofuels and alternative fuels. The SHR process has demonstrated potentials to produce high quality RNG from biomass waste more efficiently than competing renewable energy technologies including anaerobic digesters. Based on a preliminary feedstock availability assessment, a wide-scale implementation of this technology can help to support about 5% of the natural gas consumption in California.

Table 5: Projects Completed between January 1 & December 31, 2014

Contract	Contractor	Project Title	Date
-----------------	-------------------	----------------------	-------------

Infrastructure and Deployment

06028	Consolidated Disposal Service, LLC	Purchase & Install CNG Fueling System at Long Beach Waste Transfer Station	Jul-14
07051	City of Pasadena	Purchase & Install New Public Access CNG Fueling Station	Mar-14
07244	SunLine Transit Agency	Upgrade Existing Public Access CNG Fueling Stations in Thousand Palms & Indio	Apr-14
07245	USA Waste of California, Inc.	Purchase & Install New LNG Production Facility Using Landfill Gas from Altamont Landfill in Livermore	Dec-14
08030	TNT Blanchard	Repower Four Off-Road Construction Vehicles	Jun-14
08101	Pupil Transportation Cooperative	Upgrade Existing Full Public Access CNG Fueling Station in Whittier	Jun-14
09308	Trillium CNG (formerly Pinnacle)	Maintain & Manage SCAQMD's Diamond Bar Headquarters' Fast-Fill CNG Refueling Station	Nov-14
10034	California Cartage Company	Install Two LNG Fueling Stations at the Ports	Nov-14
10054†	Applied LNG Technologies	Upgrade & Perform Emergency Repairs of L/CNG Refueling Facility	Dec-14
10055	Waste Management	Install New Public Access CNG Refueling Station in Santa Ana	Dec-14
11561	SuperShuttle International, Inc.	Purchase & Deploy 34 CNG Shuttle Vans	Oct-14
12259	A-1 Alternative Fuel Systems	Demonstrate Natural Gas-Powered Police Pursuit Vehicle	Oct-14

Emission Control Technologies

10696	Johnson Matthey, Inc.	Optimize & Demonstrate Selective Catalytic Regenerating Technology (SCRT) for NO _x & PM Emissions Control	Dec-14
10697	Johnson Matthey, Inc.	Optimize & Demonstrate Selective Catalytic Continuously Regenerating Technology (SCCRT) for NO _x & PM Emissions Control	Dec-14
12113	Southern Counties Terminals dba Griley Air Freight	Retrofit Nine Heavy-Duty Diesel Trucks with DPFs	Mar-14
12114	South Bound Express, Inc.	Retrofit Three Heavy-Duty Diesel Trucks with DPFs	Mar-14
12118	National Ready Mixed Concrete, Co.	Retrofit 13 Heavy-Duty Diesel Trucks with DPFs	Mar-14
12120	Standard Concrete Products, Inc.	Retrofit 15 Heavy-Duty Diesel Trucks with DPFs	Mar-14
12121	Challenge Dairy Products, Inc.	Retrofit Three Heavy-Duty Diesel Trucks with DPFs	Mar-14

Table 5: Projects Completed between January 1 & December 31, 2014

Contract	Contractor	Project Title	Date
<i>Emission Control Technologies (cont'd)</i>			
12122	Bear Trucking, Inc.	Retrofit One Heavy-Duty Diesel Truck with DPFs	Mar-14
12123	RRM Properties Ltd.	Retrofit 127 Heavy-Duty Diesel Trucks with DPFs	Mar-14
12124	Gaio Trucking, Inc.	Retrofit Eight Heavy-Duty Diesel Trucks with DPFs	Mar-14
12125	Spragues Ready Mix	Retrofit Four Heavy-Duty Diesel Trucks with DPFs	Mar-14
12175	RRM Properties Ltd.	Retrofit Seven Heavy-Duty Diesel Trucks with DPFs	Mar-14
12186	Pipeline Carriers Inc.	Retrofit Ten Heavy-Duty Diesel Trucks with DPFs	Mar-14
13407	Chaffey Joint Union High School District	Demonstrate DPF Technology on Two School Buses	Mar-14
<i>Electric/Hybrid Technologies & Infrastructure</i>			
11614	Transportation Power, Inc.	Demonstrate Battery Electric Heavy-Duty Trucks	Sep-14
11725†	Puente Hills Nissan	Lease Three Nissan Leaf Electric Vehicles for 39 Months	Aug-14
12020	Chargepoint	Upgrade & Install Electric Charging Infrastructure	Apr-14
12825†	BMW of Monrovia	Lease Two BMW ActiveE Electric Vehicles for Two Years	Jun-14
12889†	BMW of Monrovia	Lease Two BMW ActiveE Electric Vehicles for Two Years	Jun-14
13149	UCLA Luskin Center for Innovation	Develop Southern California PEV Readiness Plan	Mar-14
<i>Mobile Fuel Cell Technologies</i>			
15388	Bevilacqua-Knight, Inc.	Participate in California Fuel Cell Partnership for CY 2014 & Provide Support for Regional Coordinator	Dec-14
<i>Hydrogen Technologies & Infrastructure</i>			
04185	Quantum Fuel Systems Technologies Worldwide Inc.	Develop & Demonstrate Hydrogen ICE Vehicles for Five Cities Program	Apr-14
13146†	California State University Los Angeles	Lease One Toyota Prius Hydrogen-Fueled Vehicle	Mar-14
<i>Health Impacts Studies</i>			
11527	University of Southern California	Study Sources, Composition, Variability & Toxicological Characteristics of Ultrafine Particles in Southern California	Dec-14

Table 5: Projects Completed between January 1 & December 31, 2014

Contract	Contractor	Project Title	Date
Health Impacts Studies (cont'd)			
12197	University of California Riverside/CE-CERT	Health Effects of PM Emissions from Heavy-Duty Vehicles—A Comparison Between Different Biodiesel Fuels	Mar-14
Stationary Clean Fuel Technologies			
09304	Solar Integrated Technologies, Inc.	Install & Evaluate Two 40kW (AC) PV Systems at SCAQMD Headquarters	Dec-14
11208†	Long Beach Unified School District	Long Beach USD Air Filtration MOA	Dec-14
13078	University of California Riverside/CE-CERT	Conversion of Biowaste to Natural Gas using Steam Hydrogasification	Dec-14
Outreach and Technology Transfer			
13078	University of California Riverside/CE-CERT	Conversion of Biowaste to Natural Gas using Steam Hydrogasification	Dec-14
07060†	Don Breazeale and Associates Inc.	Technical Assistance Related to Air Quality Impacts of Regional Goods Movement	May-14
07129†	Breakthrough Technologies Institute, Inc.	Technical Assistance with Fuel Cell Technology	Mar-14
11182†	Tech Compass	Technical Assistance with Alternative Fuels, Fuel Cells, Emissions Analysis and Aftertreatment Technologies	Dec-14
12309†	TIAX LLC	Technical Assistance with Low- and Zero-Emission Vehicles, Fuel Cells and Fueling Infrastructure	Apr-14
12604†	Joseph C. Calhoun, P.E., Inc.	Technical Assistance with Low- and Zero-Emission Vehicles, Technology & Emissions Analysis	Dec-14
13081†	Burnett & Burnette	Technical Assistance in Evaluation and Assessing New Installations of Alternative Fueling Stations	Apr-14

†Two-page summary reports (as provided in Appendix C) are not required for level-of-effort technical assistance contracts, leases or cosponsorships; or it was unavailable at time of printing this report.

CLEAN FUELS PROGRAM 2015 PLAN UPDATE

The Clean Fuels Program (Program) was first created in 1988, along with the SCAQMD's Technology Advancement Office (TAO). Funding for the Program is received through a \$1 motor vehicle registration fee. The Clean Fuels Program continually seeks to support the development and deployment of zero and near-zero emission technologies over a broad array of applications and spanning near- and long-term implementation. Planning has been and remains an ongoing activity for the Program, which must remain flexible to address evolving technologies as well as the latest progress in the state-of-technologies, new research areas and data.

Every year the SCAQMD re-evaluates the Clean Fuels Program based on the region's ongoing need for emissions reductions and develops a Plan Update for the upcoming calendar year (CY) targeting near-term projects to help achieve those reductions. This portion of this comprehensive document is the Plan Update for 2015.

Overall Strategy

The overall strategy of the SCAQMD's Clean Fuels Program is based primarily on technology needs identified through the Air Quality Management Plan (AQMP) process and the SCAQMD Board's directives to protect the health of residents in Southern California, which encompasses approximately 16.8 million people (nearly half the population of California). The AQMP is the long-term "blueprint" that defines:

- the basin-wide emission reductions needed to achieve federal ambient air quality standards;
- the regulatory measures to achieve those reductions;
- the timeframes to implement these proposed measures; and
- the technologies required to meet these future proposed regulations.

The 2012 AQMP identified the need for 200 tons/day oxides of nitrogen (NO_x) reductions to be adopted by 2020 for full implementation by 2023 and in large part focuses control measures on transportation technologies and cleaner fuels. These emission reduction needs are further identified in a joint SCAQMD, California Air Resources Board (CARB) and San Joaquin Air Pollution Control District effort, "Vision for Clean Air: A Framework for Air Quality and Climate Control Planning."² Moreover, the SCAQMD is currently only one of two regions in the nation recognized as an extreme ozone nonattainment area (the other is San Joaquin Valley). Ozone (smog) is created by a chemical reaction between NO_x and VOCs emissions at ground level. This is especially noteworthy because the largest contributor to ozone is NO_x emissions, and mobile sources (on- and off-road as well as aircraft and ships) contribute to more than three-fourths of the NO_x emissions in this region.

The daunting challenge to reduce ozone and NO_x require the Clean Fuels Program to encourage and accelerate advancement of transformative fuel and transportation technologies, leading the way for commercialization of progressively lower-emitting fuels and vehicles. If this region hopes to meet the 8-hour ozone standard (80 ppb) by 2023 (or the revised standard of 75 ppb by 2032), it is projected that a 65% reduction in NO_x is required. The NO_x and VOC emission

² http://www.arb.ca.gov/planning/vision/docs/vision_for_clean_air_public_review_draft.pdf

sources of greatest concern to this region are heavy-duty on-road and off-road vehicles as well as to a lesser extent light- and medium-duty on-road vehicles. To underscore this concern, the 2013 Vehicle Technologies Market Report³, released in early 2014 by the Oak Ridge National Laboratory for the Department of Energy, and corroborated by EMFAC 2011 projections, notes that Class 8 trucks comprise 41% of the medium- and heavy-duty truck fleet but consume 78% of the fuel use in this sector. This is especially significant since the report also notes that Class 8 truck sales have continued to increase significantly since 2009. In addition to NO_x and VOCs, fine particulate matter (PM_{2.5}) produced from mobile sources must also be reduced. From preliminary 2014 data, it appears the region may not have reached attainment of the 2014 standard for PM_{2.5}. A supplement to the 24-hour PM_{2.5} State Implementation Plan (SIP) will focus on achieving the PM_{2.5} standard in 2015, and a 2016 AQMP will focus on achieving the ozone standards. Given the relationship between NO_x and ozone and possible control strategies that might be identified for PM_{2.5} attainment by 2015, the 2015 Plan Update must emphasize emission reductions in these areas.

In recent years, it has become increasingly clear that the effect of containers being moved through the Ports of Los Angeles and Long Beach and the subsequent movement of goods throughout the region not only have a dramatic impact on air quality but also the quality of life to the communities along the major goods movement corridors. In recognition of these impacts, in the last couple of years, the SCAQMD has initiated a concerted effort to develop and demonstrate zero and near-zero emissions' goods movement technologies, such as electric trucks, plug-in hybrid trucks with all-electric range, zero emission container transport technologies, trucks operating from wayside power including catenary technology and heavy-duty technologies. The preliminary findings from the Multiple Air Toxics Exposure Study (MATES) IV⁴, which included local scale studies near large sources such as ports and freeways, reinforce the importance of these impacts and the need for transformative transportation technologies, especially near the ports and goods movement corridor.

For over 20 years, a key strategy of the Clean Fuels Program has been its implementation as a public-private partnership in conjunction with private industry, technology developers, academic institutions, research institutions and government agencies. This public-private partnership has allowed the Program to leverage its funding with at least \$3 spend on R&D projects to every \$1 of SCAQMD funds.

As the state and federal governments have turned a great deal of their attention to climate change, the SCAQMD has remained committed to developing, demonstrating and commercializing zero and near-zero emission technologies. Fortunately many, if not the majority, of technology sectors that address our need for NO_x reductions also garner greenhouse gas (GHG) reductions. Due to these "co-benefits," we have been successful in partnering with the state and federal grants.

Funding Scope

This 2015 Plan Update includes projects to develop, demonstrate and commercialize a variety of technologies, from near-term to long-term, that are intended to provide solutions to the emission control measures identified in the 2012 AQMP and to address the increasing challenges this region is facing to meet air quality standards, including (1) new and changing federal requirements such as the newer 2032 ozone standard in addition to the current 2023 standard, (2)

³ <http://cta.ornl.gov/vtmarketreport/index.shtml>

⁴ <http://www.aqmd.gov/home/library/air-quality-data-studies/health-studies/mates-iv>

implementation of new technology measures, and (3) the continued development of economically sound compliance approaches. The scope of projects in the 2015 Plan Update also needs to remain sufficiently flexible to address new challenges and proposed methodologies that are identified in the 2012 AQMP, to consider dynamically evolving technologies, and to incorporate new research and data, such as the draft findings from the MATES IV study, which was undertaken to update the emissions inventory of toxic air contaminants and conduct a regional modeling effort to characterize risk to health across the Basin. The study included measuring ultrafine particle and black carbon concentrations, as well as the white papers under development for the 2016 AQMP, which will focus on addressing ozone standards. Finally, given the increasing call for action by the federal government to reduce carbon and greenhouse gases (e.g., President Obama's Climate Action Plan released in June 2013), coupled with 2014-15 state budget appropriations relative to reducing greenhouse gases (GHGs), the co-benefits of technologies should also be considered.

In addition to providing for specific control measures based on known technologies and control methods, the Clean Air Act has provisions for more general measures based on future, yet-to-be-developed technologies. These "black box" measures are provided under Section 182(e)(5) of the Clean Air Act for regions that are extreme non-attainment areas, such as the South Coast Basin. Some of the technologies that are developed and demonstrated in the Clean Fuels Program may serve as control measures for the "black box."

Within the core technology areas defined later in this section, there exists a range of projects that represent near-term to long-term efforts. The SCAQMD Clean Fuels Program tends to support development, demonstration and technology commercialization efforts, or deployment, rather than fundamental research. The general time-to-product for these efforts, from long-term to near-term, is described below.

- Most technology *development* projects are expected to begin during 2015 with durations of about two years. Additional field demonstrations to gain long-term verification of performance, spanning up to two years, may also be needed prior to commercialization. Certification and ultimate commercialization would be expected to follow. Thus, development projects identified in this plan are expected to result in technologies ready for commercial introduction as soon as 2018. Projects are also proposed that may involve the development of emerging technologies that are considered longer term and, perhaps higher risk, but with significant emission reduction potential. Commercial introduction of such long-term technologies would not be expected until 2020 or later.
- More mature technologies, those ready to begin field *demonstration* in 2015, are expected to result in a commercial product in the 2016-2017 timeframe. Technologies being field demonstrated generally are in the process of being certified. The field demonstrations provide a controlled environment for manufacturers to gain real-world experience and address any end-user issues that may arise prior to the commercial introduction of the technology. Field demonstrations provide real-world evidence of a technology's performance to help allay any concerns by potential early adopters.
- *Deployment* or technology commercialization efforts focus on increasing the utilization of clean technologies in conventional applications. It is often difficult to transition users to a non-traditional technology or fuel, even if such a technology or fuel offers significant societal benefits. As a result, in addition to government's role to reduce risk by funding technology development and testing, one of government's roles is to support and offset any incremental cost through incentives to help accelerate the transition and use of the cleaner technology. The increased use and proliferation of these cleaner technologies often depends on this initial support and funding as well as efforts intended to increase confidence of

stakeholders that these technologies are real, cost-effective in the long term and will remain applicable.

Core Technologies

As previously noted, the SCAQMD Clean Fuels Program maintains flexibility to address dynamically evolving technologies incorporating the latest state-of-the-technology progress. Over the years, the SCAQMD has provided funding for projects for a wide variety of low and zero emission projects. In order to meet the upcoming 2023 8-hour ozone standard, the areas of zero and near-zero emission technologies need to be emphasized. The working definition of “near-zero” is an order of magnitude lower than the existing 0.2 g/bhp-hr NO_x. This level is 0.02 g/bhp-hr NO_x and close to a combined cycle powerplant emissions rate. This effort can be seen in the following sections and in the proposed funding distribution in Figure 24 (page 74). The major core technology areas are identified below with specific project categories discussed in more detail in the following sections. The core technology areas identified reflect the staff’s forecast for upcoming projects and needs within the basin but is not intended to be considered a budget.

Not all project categories will be funded, due to cost-share constraints, focus on the control measures identified in the 2012 AQMP and the availability of suitable projects. The technical areas identified below are clearly appropriate within the context of the current air quality challenges and opportunities for technology advancement. Within these areas there is significant opportunity for SCAQMD to leverage its funds with other funding agencies to expedite the implementation of cleaner alternative technologies in the Basin. A concerted effort is continually made to form private partnerships to leverage Clean Fuels funds. For example, there may be an upcoming opportunity to leverage state funding since SB 1204 (Lara and Pavley), which was chaptered last month, designates money from the state’s cap-and-trade program for development, demonstration and early commercialization of zero and near-zero emission truck, bus and off-road vehicles.

It should be noted, therefore, that these priorities may shift during the year in keeping with the diverse and flexible “technology portfolio” approach. Changes in priority may occur to (1) capture opportunities such as cost-sharing by the state government, the federal government, or other entities, or (2) address specific technology issues which affect residents within the SCAQMD’s jurisdiction.

The following core technology areas are listed by current SCAQMD priorities based on the goals for 2015.

Hydrogen & Fuel Cell Technologies & Infrastructure

The SCAQMD supports hydrogen infrastructure and fuel cell technologies as one option in our technology portfolio and is dedicated to assisting federal and state government programs to deploy fuel cell vehicles (FCVs) by supporting the required refueling infrastructure.

SCAQMD works closely with the California Fuel Cell Partnership (CaFCP) to further the commercialization of fuel cells for transportation and install the required hydrogen refueling infrastructure. In mid-2014 the CaFCP published Hydrogen Progress, Priorities and Opportunities, a report updating its 2012 roadmap describing the first network of commercial hydrogen stations in California, which calls for 68 hydrogen fueling stations in cluster communities at specific destinations by 2016. CEC funding awards over the last two years, along with some smaller cost-share support from SCAQMD, have made significant inroads to creating a growth path to 100 hydrogen stations, the state’s current goal for launching a commercially self-sustaining network to support a growing number of fuel cell vehicles to implement the state’s

ZEV Action Plan. Furthermore, in September 2013 the Governor signed Assembly Bill 8 providing significant funding for hydrogen stations, which will greatly assist in making the inroads necessary toward expanding the hydrogen infrastructure network in California.

Calendar Years 2015-2017 are a critical timeframe for the introduction of FCVs. In fact, several automakers are scheduled to release products in 2015-2016, Hyundai being the first to already offer a FCV for lease in 2014. Since stations need one to two years lead time for permitting and construction, plans for stations need to be initiated now. While coordination efforts with the Division of Measurement Standards to establish standardized measurements for hydrogen refueling started in 2014, additional efforts to offer hydrogen for sale to general consumers is still needed. In addition, new business models and funding besides grants for construction need to be explored to enable the station operations to remain solvent during the early years until vehicle numbers ramp up.

Commencing late 2012, the California Energy Commission (CEC), which based its AB 118 hydrogen funding strategy on CaFCP's roadmap as well as the University of California, Irvine's Advanced Power and Energy Program, has issued multiple Program Opportunity Notices for hydrogen fuel infrastructure and to date has awarded funding for 36 new hydrogen fueling stations. The CEC in mid-2013 awarded the SCAQMD \$6.7 million to implement the upgrade and refurbishment of existing hydrogen fueling stations to ensure legacy stations continue operation as FCVs become available in the market. The SCAQMD received a subsequent award of \$300,000 in 2014 from CEC to implement a plan for hydrogen readiness in early market communities. The SCAQMD, working closely with state agencies, to implement these programs and continue efforts to upgrade and refurbish existing hydrogen infrastructure.

The 2015 Plan Update identifies key opportunities while clearly leading the way for pre-commercial demonstrations of original equipment manufacturer (OEM) vehicles. Future projects may include the following:

- development and demonstration of hydrogen-natural gas engine systems for medium- and heavy-duty vehicle applications as well as stationary power applications;
- continued development and demonstration of distributed hydrogen production and refueling stations, including energy stations with electricity and hydrogen co-production and higher pressure (10,000 psi) hydrogen dispensing;
- development and demonstration of cross-cutting fuel cell applications (e.g. plug-in hybrid fuel cell vehicles);
- development and demonstration of fuel cells in off-road, locomotive and marine applications;
- demonstration of fuel cell vehicles in controlled fleet applications in the Basin; and
- development and implementation of strategies with government and industry to build participation in the hydrogen market including certification and testing of hydrogen as a commercial fuel to create a business case for investing.

Electric/Hybrid Technologies & Infrastructure

If the region hopes to meet the federal standards for PM_{2.5} and ozone, a primary focus must be on zero and near-zero emission technologies. A leading strategy to achieve these goals is the wide-scale implementation of electric drive systems for all applicable technologies. With that in mind, the SCAQMD seeks to support projects to address the main concerns regarding cost, battery lifetime, travel range, charging station infrastructure and manufacturer commitment. Integrated transportation systems can encourage further reduction of emissions by matching the features of electric vehicles (zero emissions, zero start-up emissions, limited range) to typical consumer

demands for mobility by linking them to transit. Additionally, the impact of fast charging on battery life and infrastructure costs is not well understood.

The development and deployment of zero emission goods movement systems remains one of the top priorities for the SCAQMD to support a balanced and sustainable growth in the port complex. The SCAQMD continues to work with our regional partners, in particular the Ports of Los Angeles and Long Beach, the Southern California Association of Governments (SCAG) and Los Angeles County Metropolitan Transportation Association (LACMTA), to identify technologies which could be beneficial to and garner support from all stakeholders. Specific technologies include zero emission trucks (using batteries and/or fuel cells), near-zero emission trucks with all-electric range using wayside power (catenary or roadbed electrification), locomotives with near-zero emissions (e.g., 90% below Tier 4), electric locomotives using battery tender cars and catenary, and linear synchronous motors for locomotives and trucks.

There is a high level of interest from major automobile manufacturers for hybrid-electric technologies in light-, medium- and heavy-duty applications as well as off-road equipment. In particular, there are increasing numbers of diesel- and gasoline-fueled hybrid-electric vehicles and multiple models of light-duty plug-in hybrid and battery electric vehicles (BEVs). Such vehicles offer the benefits of higher fuel economy and range as well as lower emissions. Hybrid electric technology is not limited to gasoline and diesel engines and can be coupled with natural gas engines, microturbines and fuel cells for further emission benefits. Additionally, continued advancements in the light-duty arena which, while there is commercially available product, is not yet mainstream technology, may have applications for medium- and heavy-duty vehicles. In fact, the goal of SB 1275 (de León), chaptered last month, is to bring one million emission electric vehicles to California over the next ten years as well as to ensure that disproportionately impacted communities benefit from this transition toward cleaner transportation.

Opportunities to develop and demonstrate technologies that could enable expedited widespread use of electric and hybrid-electric vehicles in the Basin include the following:

- development and demonstration of hybrid and electric technologies for goods movement, e.g., series hybrids with all electric range and trolley trucks on catenary wayside power;
- evaluation and demonstration of light-, medium- and heavy-duty plug-in hybrid electric vehicles;
- development and demonstration of CNG hybrid vehicle;
- demonstration of full performance and niche application battery electric vehicles;
- demonstration of integrated programs that make best use of electric drive vehicles through interconnectivity between fleets of electric vehicles and mass transit, and web-based reservation systems that allow multiple users;
- demonstration of heavy-duty battery electric vehicles;
- demonstration of heavy-duty hybrid vehicles including hydraulic and series hybrid concepts;
- development of streamlined implementation procedures to prepare and accelerate EV market penetration and commercialization; and
- demonstration and installation of EV infrastructure to support the electric and hybrid-electric vehicle fleets currently on the roads or soon entering the market, and to reduce cost, improve convenience and integrate with renewable energy and building demand management strategies (e.g., vehicle-to-grid or vehicle-to-building functionality).

Engine Systems

Natural gas engines are experiencing huge market growth due to the low cost of fuel. In order to achieve the emission reductions required for the South Coast Air Basin, the internal combustion engines (ICEs) used in the heavy-duty sector will require emissions much lower, i.e., 90% than the 2010 standards. Future projects will support the development, demonstration and certification of engines that can achieve these massive emissions reductions using an optimized systems approach. Specifically, these projects are expected to target the following:

- development of ultra-low emissions natural gas engines for heavy-duty vehicles and high horsepower applications;
- continued development and demonstration of alternative fuel medium-duty and heavy-duty engines and vehicles;
- development and demonstration of alternative fuel engines for off-road applications;
- evaluation of alternative engine systems such as compressed air propulsion and hydraulic plug-in hybrid vehicles;
- development and demonstration of engine systems that employ advance fuel or alternative fuels, engine design features, improved exhaust or recirculation systems, and aftertreatment devices;
- development and demonstration of engine systems that employ advance fuel or alternative fuels, engine design features, improved exhaust or recirculation systems, and aftertreatment devices.

Infrastructure and Deployment (Natural Gas)

The importance of natural gas and related refueling infrastructure cannot be overemphasized for the realization of large deployment of alternative fuel technologies. Significant demonstration and commercialization efforts funded by the Clean Fuels Program as well as other local, state and federal agencies are underway to: 1) support the upgrade and buildup of public and private infrastructure projects, 2) expand the network of public-access and fleet fueling stations based on the population of existing and anticipated vehicles, and 3) put in place infrastructure that will ultimately be needed to accommodate transportation fuels with very low gaseous emissions.

Compressed and liquefied natural gas (CNG and LNG) refueling stations are being positioned to support both public and private fleet applications. Upgrades and expansions are also needed to refurbish or increase capacity for some of the stations installed five years ago as well as standardize fueling station design, especially to ensure growth of alternative fuels throughout the South Coast Air Basin and beyond. Funding has been provided at key refueling points for light-, medium- and heavy-duty natural gas vehicle users traveling from the local ports, along I-15 and The Greater Interstate Clean Transportation Corridor (ICTC) Network.

Active participation in the development of NFPA fire and safety codes and standards, evaluation of the cost and economics of the new fuels, public education and training and emergency response capability are just a few areas of the funded efforts that have overcome public resistance to these new technologies. Some of the projects expected to be developed and co-funded for infrastructure development are:

- development and demonstration of renewable natural gas as a vehicle fuel from renewable feedstocks and biowaste;
- development and demonstration of advanced, cost effective methods for manufacturing synthesis gas for conversion to renewable natural gas;
- deployment of natural gas home refueling appliances for light-duty vehicles;
- enhancement of safety and emissions reduction from LNG refueling equipment;

- expansion of fuel infrastructure, fueling stations, and equipment; and
- expansion of infrastructure connected with existing fleets, public transit, and transportation corridors.

Emissions, Fuels and Health Impacts Studies

The monitoring of pollutants in the Basin is extremely important, especially when focused on (1) a particular sector of the emissions inventory (to identify the responsible technology) or (2) exposure to pollution (to assess the potential health risks). Recent studies indicate that smoggy areas can produce irreversible damage to children's lungs. This information highlights the need for further emissions and health studies to identify the emissions from high polluting sectors as well as the health effects resulting from these technologies.

Over the past few years, the SCAQMD has funded emission studies to evaluate the impact of tailpipe emissions of biodiesel and ethanol fueled vehicles mainly focusing on criteria pollutants and greenhouse gas (GHG) emissions. These studies showed that biofuels, especially biodiesel, can contribute to higher NO_x emissions while reducing other criteria pollutant emissions. Furthermore, despite recent advancements in toxicological research related to air pollution, the relationship between particle chemical composition and health effects is still not completely understood, especially for biofuels. Therefore, a couple of years ago the SCAQMD funded studies to investigate the physical and chemical composition and toxicological potential of tailpipe PM emissions from biodiesel and ethanol fueled vehicles to better understand their impact on public health. Studies have continued in 2014 to further investigate the toxicological potential of emissions, such as ultrafine particles and vapor phase substances, and to determine whether or not other substances such as volatile or semi-volatile organic compounds are being emitted in lower mass emissions that could pose harmful health effects.

In recent years, there has also been an increased interest both at the state and national level on the use of alternative fuels including biofuels to reduce petroleum oil dependency, GHG emissions and air pollution. In order to sustain and increase biofuel utilization, it is essential to identify feedstocks that can be processed in a more efficient, cost-effective and sustainable manner. One such fuel that the Clean Fuels Program is interested in pursuing is dimethyl ether (DME). This synthetic fuel can be made from renewable natural gas resources and has characteristics similar to gas-to-liquids fuels, i.e., high cetane, zero aromatics and negligible emissions of particulate matter. Volvo has announced they will commercialize class 8 trucks using DME in 2015, and staff would like to ensure these trucks have lower NO_x than the existing standard. A study in 2015 on DME is being proposed.

Some areas of focus include:

- demonstration of remote sensing technologies to target different high emission applications and sources;
- studies to identify the health risks associated with ultrafines and ambient particulate matter including their composition to characterize their toxicity and determine specific combustion sources;
- in-use emissions studies using biofuels including DME to evaluate in-use emission composition;
- in-use emissions studies to determine the impact of new technologies, in particular PEVs on local air quality as well as the benefit of telematics on emissions reduction strategies;
- lifecycle energy and emissions analyses to evaluate conventional and alternative fuels; and
- analysis of fleet composition and their associated impacts.

Stationary Clean Fuel Technologies

Although stationary source emissions are small compared to mobile sources in the South Coast Air Basin, there are areas where cleaner fuel technology can be applied to reduce NO_x, VOC and PM emissions. For example, inspections suggest there is a large population of small ICE generators within the Basin that are operating outside their permit limits due to poor maintenance, deliberate tuning for different performance, operation outside equipment design or changes in fuel quality. Cleaner, more robust distributed generation technologies exist that could be applied to not only improve air quality, but enhance power quality and reduce electricity distribution congestion.

The use of renewable feedstocks for energy production is a viable and necessary strategy to provide sustainable power for future needs while reducing greenhouse gas emissions and achieving domestic energy diversity. One of the projects that the SCAQMD recently supported in this effort was a bench scale demonstration project using a steam hydrogasification process to produce natural gas from biomass and biosolid (sewage sludge) feedstocks. Steam Hydrogasification Reaction (SHR) has been developed to produce various forms of energy products from carbonaceous resources. SHR is capable of handling wet feedstocks like sludge, does not require expensive oxygen plants and has been demonstrated to be most efficient and cost-effective compared to other conventional gasification technologies. This project successfully demonstrated that the SHR process coupled with a water-gas shift (WGS) reactor can produce natural gas containing up to 90% methane.

Additionally, alternative energy storage could be achieved through vehicle to grid or vehicle to building technologies. The University of California Riverside's Sustainable Integrated Grid Initiative, funded in part by the SCAQMD and launched in 2014, for example could assist in the evaluation of these technologies. Projects conducted under this category may include:

- development and demonstration of reliable, low emission stationary technologies (e.g., low NO_x burners, fuel cells or microturbines);
- exploration of renewables as a source for cleaner stationary technologies;
- evaluation, development and demonstration of advanced control technologies for stationary sources; and
- vehicle-to-grid or vehicle-to-building demonstration projects to develop sustainable, low emission energy storage alternatives

Emission Control Technologies

Although engine technology and engine systems research is required to reduce the emissions at the combustion source, post-combustion cleanup methods are also needed to address the current installed base of on-road and off-road technologies. Existing diesel emissions can be greatly reduced with aftertreatment controls such as particulate matter (PM) traps and catalysts, as well as lowering the sulfur content or using additives with diesel fuel. Gas-to-Liquid (GTL) fuels, formed from natural gas or other hydrocarbons rather than petroleum feedstock and emulsified diesel, provide low emission fuels for use in diesel engines. As emissions from engines become lower and lower, the lubricant contributions to VOC and PM emissions become increasingly important. The most promising of these technologies will be considered for funding, specifically:

- evaluation and demonstration of new emerging liquid fuels, including alternative and renewable diesel and GTL fuels;
- development and demonstration of advanced aftertreatment technologies for mobile applications (including diesel particulate traps and selective catalytic reduction catalysts);

- development and demonstration of low-VOC and PM lubricants for diesel and natural gas engines; and

Outreach and Technology Transfer

Since the value of the Clean Fuels Program depends on the deployment and adoption of the demonstrated technologies, outreach and technology transfer efforts are essential to its success. This core area encompasses assessment of advanced technologies, including retaining outside technical assistance as needed, efforts to expedite the implementation of low emission and clean fuels technologies, coordination of these activities with other organizations and information dissemination to educate the end user. Technology transfer efforts include support for various clean fuel vehicle incentive programs as well.

Target Allocations to Core Technology Areas

Figure 24 below presents the potential allocation of available funding, based on SCAQMD projected program costs of nearly \$16.4 million for all potential projects. The expected actual project expenditures for 2015 will be less than the total SCAQMD projected program cost since not all projects will materialize. The target allocations are based on balancing technology priorities, technical challenges and opportunities discussed previously and near-term versus long-term benefits with the constraints on available SCAQMD funding. Specific contract awards throughout 2015 will be based on this proposed allocation, the quality of proposals received and evaluation of projects against standardized criteria and ultimately SCAQMD Governing Board approval.

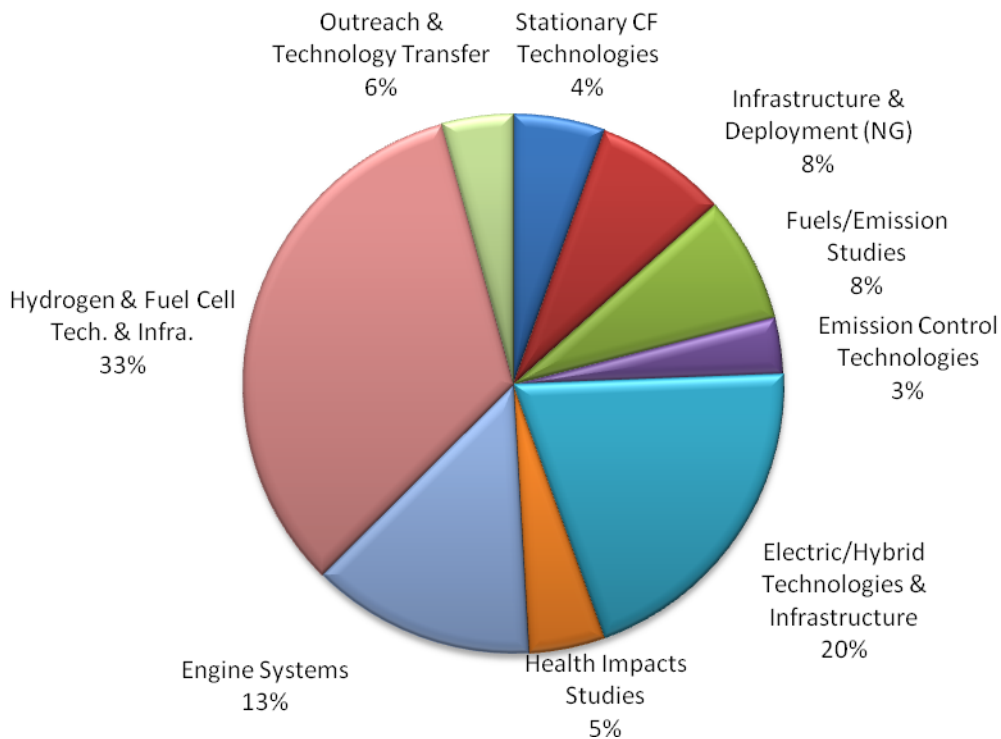

Figure 24: Projected Cost Distribution for Potential SCAQMD Projects in 2015 (\$16.4M)

PROGRAM PLAN UPDATE FOR 2015

This section presents the Clean Fuels Program Plan Update for 2015. The proposed projects are organized by program areas and described in further detail, consistent with the SCAQMD budget, priorities and the best available information on the state-of-the-technology. Although not required, this Plan also includes proposed projects that may be funded by revenue sources other than the Clean Fuels Program, specifically related to VOC and incentive projects.

Table 6 summarizes potential projects for 2015 as well as the distribution of SCAQMD costs in some areas as compared to 2015. The funding allocation continues the focus toward development and demonstration of zero and near-zero emission technologies including the infrastructure for such technologies. However, while the SCAQMD had over the last couple of years emphasized electric and hybrid-electric technologies, the intent is to continue to allow the projects in this core technology area to achieve some progress while the Program is slightly re-calibrated to focus on the current federal and state activity in hydrogen and fuel cells and the anticipated roll out of fuel cell vehicles in 2015-2016. Some additional funding has also been shifted to Fuels and Emissions Studies in order to further evaluate biofuels including DME and to partner with the National Renewable Energy Laboratory (NREL) on a fleet and technology matching analysis. Like the prior year, the funding allocations again align well with the SCAQMD's FY 2014-15 Goals and Priority Objectives. Overall, the Program is designed to ensure a broad portfolio of technologies and leverage state and federal efforts.

Each of the proposed projects described in this Plan, once fully developed, will be presented to the SCAQMD Governing Board for approval prior to contract initiation. This development reflects the maturity of the proposed technology, identification of contractors to perform the projects, host site participation, securing sufficient cost-sharing to complete the project and other necessary factors. Recommendations to the SCAQMD Governing Board will include descriptions of the technology to be demonstrated and in what application, the proposed scope of work of the project and the capabilities of the selected contractor and project team, in addition to the expected costs and expected benefits of the projects as required by H&SC 40448.5.1.(a)(1). Based on communications with all of the organizations specified in H&SC 40448.5.1.(a)(2) and review of their programs, the projects proposed in this Plan do not appear to duplicate any past or present projects.

Funding Summary of Potential Projects

The remainder of this section contains the following information for each of the potential projects summarized in Table 6 (page 77).

Proposed Project: A descriptive title and a designation for future reference.

Expected SCAQMD Cost: The estimated proposed SCAQMD cost share as required by H&SC 40448.5.1.(a)(1).

Expected Total Cost: The estimated total project cost including the SCAQMD cost share and the cost share of outside organizations expected to be required to complete the proposed project. This is an indication of how much SCAQMD public funds are leveraged through its cooperative efforts.

Description of Technology and Application: A brief summary of the proposed technology to be developed and demonstrated, including the expected vehicles, equipment, fuels, or processes that could benefit.

Potential Air Quality Benefits: A brief discussion of the expected benefits of the proposed project, including the expected contribution towards meeting the goals of the AQMP, as required by H&SC 40448.5.1.(a)(1). In general, the most important benefits of any technology research, development

and demonstration program are not necessarily realized in the near term. Demonstration projects are generally intended to be proof-of-concept for an advanced technology in a real-world application. While emission benefits, for example, will be achieved from the demonstration, the true benefits will be seen over a longer term, as a successfully demonstrated technology is eventually commercialized and implemented on a wide scale.

Table 6: Summary of Potential Projects for 2015

Proposed Project	Expected SCAQMD Cost \$	Expected Total Cost \$
Hydrogen and Fuel Cell Technologies and Infrastructure		
Develop and Demonstrate Operation and Maintenance Business Case Strategies for Hydrogen Stations	350,000	4,000,000
Develop and Demonstrate Distributed Hydrogen Production and Fueling Stations	2,000,000	6,000,000
Develop and Demonstrate Medium- and Heavy-Duty Fuel Cell Vehicles	3,000,000	10,000,000
Demonstrate Light-Duty Fuel Cell Vehicles	100,000	100,000
Subtotal	\$5,450,000	\$20,100,000
Electric/Hybrid Technologies & Infrastructure		
Demonstrate Light-Duty Plug-In Hybrid & Battery Electric Vehicles and Infrastructure	1,100,000	2,000,000
Develop and Demonstrate Medium- and Heavy-Duty Hybrid Vehicles and Infrastructure	600,000	1,800,000
Demonstrate Alternative Energy Storage	300,000	2,000,000
Develop and Demonstrate Electric Container Transport Technologies	1,300,000	2,600,000
Subtotal	\$3,300,000	\$8,400,000
Engine Systems		
Develop and Demonstrate Advanced Alternative Fuel Medium- and Heavy-Duty Engines and Vehicles	2,000,000	20,000,000
Develop and Demonstrate Alternative Fuel and Clean Conventional Fueled Light-Duty Vehicles	200,000	1,500,000
Subtotal	\$2,200,000	\$21,500,000
Infrastructure and Deployment (NG)		
Deploy Natural Gas Vehicles in Various Applications	500,000	2,000,000
Develop, Maintain & Expand Natural Gas Infrastructure	300,000	2,000,000
Demonstrate Natural Gas Manufacturing and Distribution Technologies Including Renewables	500,000	7,000,000
Subtotal	\$1,300,000	\$11,000,000
Fuels/Emission Studies		
In-Use Emissions Studies for Advanced Technology Vehicle Demonstrations	500,000	1,000,000
Conduct Emissions Studies on Biofuels and Alternative Fuels	500,000	1,300,000

Table 6: Summary of Potential Projects for 2015 (cont'd)

Proposed Project	Expected SCAQMD Cost \$	Expected Total Cost \$
Fuels/Emission Studies (cont'd)		
Identify and Demonstrate In-Use Fleet Emissions Reduction Technologies & Opportunities	250,000	2,000,000
Subtotal	\$1,250,000	\$4,300,000
Health Impacts Studies		
Evaluate Ultrafine Particle Health Effects	250,000	3,000,000
Conduct Monitoring to Assess Environmental Impacts	250,000	1,000,000
Assess Sources and Health Impacts of Particulate Matter	250,000	300,000
Subtotal	\$750,000	\$4,300,000
Stationary Clean Fuel Technologies		
Develop and Demonstrate Reliable, Low Emission Monitoring Systems and Test Methods	250,000	500,000
Develop and Demonstrate Clean Stationary Technologies	250,000	750,000
Develop and Demonstrate Renewables-Based Energy Generation Alternatives	200,000	1,000,000
Subtotal	\$700,000	\$2,250,000
Emission Control Technologies		
Develop and Demonstrate Advanced Aftertreatment Technologies	300,000	5,000,000
Demonstrate On-Road Technologies in Off-Road and Retrofit Applications	250,000	1,000,000
Subtotal	\$550,000	\$6,000,000
Outreach and Technology Transfer		
Assessment and Technical Support of Advanced Technologies and Information Dissemination	500,000	800,000
Support for Implementation of Various Clean Fuels Vehicle Incentive Programs	400,000	400,000
Subtotal	\$900,000	\$1,200,000
TOTALS FOR POTENTIAL PROJECTS	\$16,400,000	\$79,050,000

Technical Summaries of Potential Projects

Hydrogen and Fuel Cell Technologies & Infrastructure

Proposed Project: Develop and Demonstrate Operation and Maintenance Business Case Strategies for Hydrogen Stations

Expected SCAQMD Cost: \$350,000

Expected Total Cost: \$4,000,000

Description of Technology and Application:

California regulations require automakers to place increasing numbers of zero emission vehicles into service every year. By 2050, CARB projects that 87% of light-duty vehicles on the road will be zero emission battery and fuel cell vehicles with fuel cell electric becoming the dominant powertrain.

In 2013, cash-flow analysis resulting in a Hydrogen Network Investment Plan and fuel cell vehicle development partnership announcements by major automakers enabled the passage of AB 8 which provides \$20 million per year for hydrogen infrastructure cofunding through the CEC. This resulted in limited fuel cell vehicle production announcements by Hyundai, Toyota and Honda for 2014-2015.

In mid-2014 the CaFCP published the *Hydrogen Progress, Priorities and Opportunities* (HyPPO) report, an update of their roadmap describing the first network of commercial hydrogen stations in California.

Additional work in this project category would develop a plan to secure long-term funding to complete the hydrogen fueling network build-out, provide details how funding can be invested, assess alternative revenue streams such as renewable incentives, propose alternative financing structures to leverage/extend CEC funding, and support station operation during the transition to commercial viability.

Potential Air Quality Benefits:

The 2012 AQMP identifies the use of alternative fuels and zero emission transportation technologies as necessary to meet federal air quality standards. One of the major advantages of Fuel Cell vehicles (FCEVs) is the fact that they use hydrogen, a fuel that can be domestically produced from a variety of resources such as natural gas, solar, wind and biomass. The technology and means to produce hydrogen fuel to support FCEVs are available now. The deployment of large numbers of FCEVs, which is an important strategy to attain air quality goals, requires a well planned and robust hydrogen fueling infrastructure. This SCAQMD program with additional funding from other entities will provide the hydrogen fueling infrastructure that is necessary in the South Coast Air Basin. The deployment of FCEVs and the development of the necessary fueling infrastructure will lead to substantial reductions in NOx, VOC, CO, PM and toxic air contaminants from vehicles.

Proposed Project: Develop and Demonstrate Distributed Hydrogen Production and Fueling Stations

Expected SCAQMD Cost: \$2,000,000

Expected Total Cost: \$6,000,000

Description of Technology and Application:

Alternative fuels, such as hydrogen and the use of advanced technologies, such as fuel cell vehicles, are necessary to meet future clean air standards. A key element in the widespread acceptance and resulting increased use of alternative fuel vehicles is the development of an infrastructure to support the refueling of vehicles, cost-effective production and distribution and clean utilization of these new fuels.

A major challenge to the entry and acceptance of direct-hydrogen fuel cell vehicles is the limited number of hydrogen refueling sites. This program would support the development and demonstration of hydrogen refueling technologies. Proposed projects would address:

- *Fleet and Commercial Refueling Stations:* Further expansion of the hydrogen fueling network based on retail models, providing renewable generation, adoption of standardized measurements for hydrogen refueling, other strategic refueling locations and increased dispensing pressure of 10,000 psi and compatibility with existing CNG stations may be considered.
- *Energy Stations:* Multiple-use energy stations that can produce hydrogen for fuel cell vehicles or for stationary power generation are considered an enabling technology with the potential for costs competitive with large-scale reforming. System efficiency, emissions, hydrogen throughput, hydrogen purity and system economics will be monitored to determine the viability of this strategy for hydrogen fueling infrastructure deployment and as a means to produce power and hydrogen from renewable feedstocks (biomass, digester gas, etc.).

Home Refueling Appliances: Home refueling/recharging is an attractive advancement for alternative clean fuels due to the limited conventional refueling infrastructure. Similar to the natural gas home refueling appliance currently commercially available, this project would evaluate a hydrogen home refueler for cost, compactness, performance, durability, emission characteristics, ease of assembly and disassembly, maintenance and operations. Other issues such as building permits, building code compliance and UL ratings for safety would also be evaluated.

It is estimated that approximately 50,000 fuel cell vehicles will be deployed by 2017 in California and the majority of these vehicles will be in the South Coast Air Basin. To provide fuel for these vehicles, the hydrogen fueling infrastructure needs to be significantly increased. SCAQMD will seek additional funding from CEC and CARB to construct and operate hydrogen fueling stations.

Potential Air Quality Benefits:

The 2012 AQMP identifies the use of alternative clean fuels in mobile sources as a key attainment strategy. Pursuant to AQMP goals, the SCAQMD has in effect several fleet rules that require public and certain private fleets to purchase clean-burning alternative-fueled vehicles when adding or replacing vehicles to their vehicle fleets. Fuel cell vehicles constitute the cleanest alternative-fuel vehicles today. Since hydrogen is a key fuel for fuel cell vehicles, this program would address some of the barriers faced by hydrogen as a fuel and thus assist in accelerating its acceptance and ultimate commercialization. In addition to supporting the immediate deployment of the demonstration fleet, expanding the hydrogen fuel infrastructure should contribute to the

market acceptance of fuel cell technologies in the long run, leading to substantial reductions in NO_x, VOC, CO, PM and toxic compound emissions from vehicles.

Proposed Project: Develop and Demonstrate Medium- and Heavy-Duty Fuel Cell Vehicles

Expected SCAQMD Cost: \$3,000,000

Expected Total Cost: \$10,000,000

Description of Technology and Application:

This proposed project would support evaluation including demonstration of promising fuel cell technologies for applications using direct hydrogen with proton exchange membrane (PEM) fuel cell technology. Battery fuel cell hybrids are another potential technology being mentioned by battery experts as a way of reducing costs and enhancing performance of fuel cell vehicles.

The California ZEV Action Plan specifies actions to help deploy an increasing number of zero emission vehicles, including medium- and heavy-duty ZEVs. Fleets are useful demonstration sites because economies of scale exist in central refueling, in training skilled personnel to operate and maintain the vehicles, in the ability to monitor and collect data on vehicle performance and for manufacturer technical and customer support. In some cases, medium- and heavy-duty fuel cell vehicles could leverage the growing network of hydrogen stations, providing an early base load of fuel consumption until the number of passenger vehicles grows. These vehicles could include hybrid-electric vehicles powered by fuel cells and equipped with batteries capable of being charged from the grid and even supplying power to the grid.

In 2012 SCAQMD launched demonstrations of Zero Emission Container Transport (ZECT) technologies. This project included development and demonstration of a fuel cell hybrid electric truck platform. In 2015 staff proposes to launch ZECT II to develop and demonstrate additional fuel cell truck platforms and vehicles.

This category may include projects in the following applications:

- | | |
|---|---|
| On-Road: | Off-Road: |
| <ul style="list-style-type: none">• Transit Buses• Shuttle Buses• Medium- & Heavy-Duty Trucks | <ul style="list-style-type: none">• Vehicle Auxiliary Power Units• Construction Equipment• Lawn and Garden Equipment• Cargo Handling Equipment |

Potential Air Quality Benefits:

The 2012 AQMP identifies the need to implement zero emission vehicles. SCAQMD adopted fleet regulations require public and some private fleets within the Basin to acquire alternatively fueled vehicles when making new purchases. In the future, such vehicles could be powered by zero emission fuel cells operating on hydrogen fuel. The proposed projects have the potential to accelerate the commercial viability of fuel cell vehicles. Expected immediate benefits include the establishment of zero- and near-zero emission proof-of-concept vehicles in numerous applications. Over the longer term, the proposed projects could help foster wide-scale implementation of zero emission fuel cell vehicles in the Basin. The proposed projects could also lead to significant fuel economy improvements, manufacturing innovations and the creation of high-tech jobs in Southern California, besides realizing the air quality benefits projected in the AQMP.

Proposed Project: Demonstrate Light-Duty Fuel Cell Vehicles

Expected SCAQMD Cost: \$100,000

Expected Total Cost: \$100,000

Description of Technology and Application:

This proposed project would support the demonstration of limited production and early commercial fuel cell passenger vehicles using gaseous hydrogen with proton exchange membrane (PEM) fuel cell technology. Recent designs of light-duty fuel cell vehicles include hybrid batteries to recapture regenerative braking and improve overall system efficiency.

With the implementation of the California ZEV Action Plan, supplemented by the existing and planned hydrogen refueling stations in the Southern California area, light-duty fuel cell limited-production vehicles are planned for retail deployment in early commercial markets near hydrogen stations by several automakers. Fleets are useful demonstration sites because economies of scale exist in central refueling, in training skilled personnel to operate and maintain the vehicles, in the ability to monitor and collect data on vehicle performance and for manufacturer technical and customer support. SCAQMD has included fuel cell vehicles as part of its demonstration fleet since our first hydrogen station began operation in 2005; strengthening support, education, and outreach regarding fuel cell vehicle technology on an on-going basis. In addition, demonstration vehicles could include hybrid-electric vehicles powered by fuel cells and equipped with larger batteries capable of being charged from the grid and even supplying power to the grid.

Potential Air Quality Benefits:

The 2012 AQMP identifies the need to implement zero emission vehicles. SCAQMD adopted fleet regulations require public and some private fleets within the Basin to acquire alternatively fueled vehicles when making new purchases. In the future, such vehicles could be powered by zero emission fuel cells operating on hydrogen fuel. The proposed projects have the potential to accelerate the commercial viability of fuel cell vehicles. Expected immediate benefits include the deployment of zero- emission vehicles in SCAQMD’s demonstration fleet. Over the longer term, the proposed projects could help foster wide-scale implementation of zero emission fuel cell vehicles in the Basin. The proposed projects could also lead to significant fuel economy improvements, manufacturing innovations and the creation of high-tech jobs in Southern California, besides realizing the air quality benefits projected in the AQMP.

Electric/Hybrid Technologies & Infrastructure

Proposed Project: Demonstrate Light-Duty Plug-In Hybrid & Battery Electric Vehicles and Infrastructure

Expected SCAQMD Cost: \$1,100,000

Expected Total Cost: \$2,000,000

Description of Technology and Application:

All of the major automobile manufacturers are currently developing and commercializing hybrid-electric vehicles, which now come in a variety of fuel economy and performance options. These commercial hybrid EVs integrate a smaller internal combustion engine, battery pack and electric drive motors to improve fuel economy (e.g., Chevy Volt) or performance (e.g., Lexus RX400h).

The SCAQMD has long supported the concept of using increased battery power to allow a portion of the driving cycle to occur in all-electric mode for true zero emission miles. This battery dominant strategy is accomplished by incorporating an advanced battery pack initially recharged from the household grid or EV chargers. This “plug-in” hybrid EV strategy allows reduced emissions and improved fuel economy. In 2009, CARB adopted Plug-In Hybrid Electric Vehicle Test Procedure Amendments and Aftermarket Parts Certification and several automobile manufacturers have announced demonstration or early production plans of “blended” plug-in hybrid electric, extended-range electric vehicles (E-rEV), or highway capable battery electric vehicles (BEVs). Electric utilities refer to PHEVs, E-rEVs and BEVs as plug-in electric drive vehicles (PEVs) and are working with automakers to support PEVs. The recent adoption of revised recommended practice SAE J1772 enables passenger vehicles to charge from 110/120V AC (Level 1), 220/240V AC (Level 2), and faster 440/480V DC charging using a common conductive connector in 30 minutes or less in the U.S. and Europe. The impact of fast charging on battery life and infrastructure costs is not well understood and will be evolving as three fast DC systems (SAE combo, CHAdeMO and Tesla) compete for international market share.

Integrated programs can interconnect fleets of electric drive vehicles with mass transit via web-based reservation systems that allow multiple users. These integrated programs can match the features of EVs (zero emissions, zero start-up emissions, short range) to typical consumer demands for mobility in a way that significantly reduces emissions of pollutants and greenhouse gases.

At recent auto shows, automakers have displayed concept plug-in fuel cell vehicles. Development and demonstration of dual fuel, zero emission vehicles could expand the acceptance of battery electric vehicles and accelerate the introduction of fuel cells in vehicle propulsion.

The SCAQMD has long been a leader in promoting early demonstrations of next generation light-duty vehicle propulsion technologies (and fuels). However, given the current and planned market offerings in this category, priorities have shifted. Nevertheless, the SCAQMD will continue to evaluate market offerings and proposed technologies in light-duty vehicles to determine if any future support is required.

This project category is to develop and demonstrate: 1) various PEV architectures; 2) anticipated costs for such architectures; 3) customer interest and preferences for each alternative; 4) prospective commercialization issues and strategies for various alternatives; 5) integration of the technologies into prototype vehicles and fleets; 6) infrastructure (especially in conjunction with the DOE and the Los Angeles Department of Water & Power) to demonstrate the potential clean air benefits of these types of vehicles; 7) support for local government outreach and charging

installation permit streamlining; and 8) evaluation of any new promising light-duty vehicle propulsion technologies or fuels.

Potential Air Quality Benefits:

The 2012 AQMP identifies zero or near-zero emitting vehicles as a key attainment strategy. HEV technologies have the potential to achieve near-zero emissions but with the range of a conventional gasoline-fueled vehicle, a factor expected to enhance consumer acceptance. Given the variety of PEV systems under development, it is critical to determine the true emissions and performance of PEVs. Demonstration of optimized prototypes would enhance the deployment of near-ZEV and ZEV technologies.

Expected benefits include the establishment of criteria for emissions evaluations, performance requirements, customer acceptability of the technology, etc. This will help both regulatory agencies and OEMs to expedite introduction of zero and near-zero emitting vehicles in the South Coast Basin, which is a high priority of the AQMP.

Proposed Project: Develop and Demonstrate Medium- and Heavy-Duty Hybrid Vehicles and Infrastructure

Expected SCAQMD Cost: \$600,000

Expected Total Cost: \$1,800,000

Description of Technology and Application:

Hybrid technologies have gained momentum in the light-duty sector with commercial offerings by most all of the automobile manufacturers. Unfortunately, the medium- and heavy-duty platforms are where most emissions reductions are required, especially for the in-use fleet due to low turnover. This project category is to investigate the use of hybrid technologies to achieve similar performance as the conventional fueled counterparts while achieving both reduced emissions and improved fuel economy. Development and validation of emission test procedures is needed, but is complicated due to the low volume and variety of medium- and heavy-duty vehicles.

Platforms to be considered include utility trucks, delivery vans, shuttle buses, transit buses, waste haulers, construction equipment, cranes and other off-road vehicles. Innovations that may be considered for demonstration include: advancements in the auxiliary power unit, either ICE or other heat engine; battery-dominant hybrid systems utilizing off-peak re-charging, with advanced battery technologies such as lithium-ion; and hydraulic energy storage technologies where applicable. Alternative fuels are preferred in these projects, e.g., natural gas, LPG, hydrogen, GTL and hydrogen-natural gas blends, but conventional fuels such as gasoline, clean diesel, or even biodiesel may be considered if the emissions benefits can be demonstrated as equivalent or superior to alternative fuels. Both new designs and retrofittable technologies and related charging infrastructure will be considered.

Federal Recovery Act funding combined with state and local support has accelerated the development and demonstration of medium-duty plug-in hybrid electric truck platforms. Analysis of project data and use profiles will help optimize drive systems, target applications for early commercialization and fill gaps in product offerings.

Potential Air Quality Benefits:

The 2012 AQMP identifies zero- or near-zero emitting vehicles as a key attainment strategy. Hybrid technologies have the potential to redirect previously wasted kinetic energy into useable vehicle power. This proposed project category will evaluate various hybrid systems and fuel combinations to identify their performance and emissions benefits. Given the variety of hybrid systems under development, it is critical to determine the true emissions and performance of these prototypes, especially if both emissions and fuel economy advantages are achieved.

Expected benefits include the establishment of criteria for emissions evaluations, performance requirements and customer acceptability of the technology. This will help both regulatory agencies and OEMs to expedite introduction of near-zero emitting vehicles in the South Coast Basin, which is a high priority of the AQMP.

Proposed Project: Demonstrate Alternative Energy Storage

Expected SCAQMD Cost: \$300,000

Expected Total Cost: \$2,000,000

Description of Technology and Application:

The SCAQMD has been involved in the development and demonstration of energy storage systems for electric and hybrid-electric vehicles, mainly Lithium ion chemistry battery packs. Over the past few years, additional technology consisting of nickel sodium chloride, lithium-ion and lithium iron phosphate batteries have shown robust performance. Other technology manufacturers have also developed energy storage devices including flywheels, hydraulic systems and ultracapacitors. Energy storage systems optimized to combine the advantages of ultracapacitors and advanced batteries could yield further benefits. This project category is to apply these advanced storage technologies in vehicle platforms to identify best fit applications, demonstrate their viability (reliability, maintainability and durability), gauge market preparedness and provide a pathway to commercialization.

The long-term objective of this program is to decrease fuel consumption and resulting emissions without any changes in performance compared to conventional vehicles. This program will support several projects for development and demonstration of different types of low emission hybrid vehicles using advanced energy strategies and conventional or alternative fuels. The overall net emissions and fuel consumption of these types of vehicles are expected to be much lower than traditional engine systems. Both new and retrofit technologies will be considered.

Potential Air Quality Benefits:

Certification of low emission vehicles and engines and their integration into the Basin's transportation sector is a high priority under the 2012 AQMP. This program is expected to develop alternative energy storage technologies that could be implemented in medium- and heavy-duty trucks, buses and other applications. Benefits will include proof of concept for the new technologies, diversification of transportation fuels and lower emissions of criteria, toxic pollutants and greenhouse gases.

Proposed Project: Develop and Demonstrate Electric Container Transport Technologies

Expected SCAQMD Cost: \$3,000,000

Expected Total Cost: \$5,000,000

Description of Technology and Application:

Advanced transportation systems can be used to transfer cargo containers from ports to both local and “distant” intermodal facilities, thereby significantly reducing emissions from on-road trucks and locomotives and also reducing traffic congestion in local transportation corridors. Such systems could be stand-alone systems that use magnetic levitation (maglev), linear synchronous motors or linear induction motors on dedicated guideways. A more near-term design could use existing roadways that are electrified with catenary electric lines or linear electric motors to move containers on modified trucks equipped to run on electricity. In both scenarios, containers are transported relatively quietly and without direct emissions. The footprints for such systems are similar to conventional rail systems but have reduced impact on adjacent property owners including noise and fugitive dust. These systems can even be built above or adjacent to freeways or on elevated guideways. These container freight systems are not designed to carry any operators on the guideways, where the over-the-roadway system may require the operator to actively control the transport of the containers.

One of the container transportation concepts the SCAQMD is actively pursuing is the eHighway catenary hybrid truck system by Siemens Mobility. Siemens and their partners have developed a catenary system and hybrid electric trucks to utilize the catenary for zero emission transport of containers. The hybrid drive system will extend the operating range of the truck beyond the all-electric range of the catenary system, thus enabling the truck to perform regional drayage operations and bridge gaps in catenary infrastructure as it is deployed on a regional level. The proposed Siemens pantograph system will allow for seamless connection and disconnection from the catenary wires. When entering the catenary system corridor, the pantograph system will verify the presence of catenary lines and allow the driver to raise the pantograph from within the cab of the truck. Upon leaving the catenary system, the pantograph automatically retracts and the truck switches to on-board power systems. The on-board power systems could be a range of technologies, including batteries, fuel cells, or internal combustion engines. In addition, SCAQMD is administering a project to develop and demonstrate zero emission drayage trucks for goods movement operations, consisting of three different battery electric truck technologies and a fuel cell hybrid electric truck platform. This project is funded by a \$4.2 million award from Department of Energy to promote the deployment of zero emission cargo transport technologies. These trucks can be also upfitted to connect to wayside power via a catenary or LSM system in the future.

In addition to these technologies, there are other options for electric container applications such as dual-mode locomotives, hybrid electric technologies with battery storage, a battery tender car, magnetic levitation, fuel cell propulsion systems and other wayside power alternatives. This program will evaluate all available technology options to determine whether their systems can be successfully developed and deployed, financially viable, and reliably operated on a long-term basis.

Potential Air Quality Benefits:

On-road heavy-duty diesel truck travel is an integral part of operations at the ports moving cargo containers into the Basin and beyond. The 2012 AQMP proposes to reduce emissions from this activity by modernizing the fleet and retrofitting NO_x and PM emission controls on older trucks.

An alternative approach, especially for local drayage to the nearby intermodal facilities, is to use advanced container transport systems that use electric propulsion for the containers on fixed guideways or modified trucks able to operate on electricity which will eliminate local diesel truck emissions. The emission benefits have not yet been estimated because the fate of the displaced trucks has not been determined.

Engine Systems

Proposed Project: Develop and Demonstrate Advanced Alternative Fuel Medium- and Heavy-Duty Engines and Vehicles

Expected SCAQMD Cost: \$2,000,000

Expected Total Cost: \$20,000,000

Description of Technology and Application:

The objective of this proposed program is to support development and certification of near commercial prototype low emission heavy-duty alternative fuel engine technologies and demonstration of these technologies in on-road vehicles. The NO_x emissions target for this program area is 0.2 g/bhp-hr and lower and the PM emissions target is below 0.01 g/bhp-hr. To achieve these targets, an effective emission control strategy must employ advance fuel or alternative fuels, engine design features, improved exhaust or recirculation systems, and aftertreatment devices that are optimized using a system approach. This program is expected to result in several projects, including:

- demonstration of advanced engines in medium- and heavy-duty vehicles and high horsepower applications;
- development of durable and reliable retrofit technologies to convert engines and vehicles from petroleum fuels to alternative fuels; and
- anticipated fuels for these projects include but are not limited to CNG, LNG, LPG, emulsified diesel and GTL fuels. The program proposes to expand field demonstration of these advanced technologies in various vehicle fleets operating with different classes of vehicles.

The use of alternative fuel in heavy-duty trucking applications has been demonstrated in certain local fleets within the Basin. These vehicles typically require 200-300 horsepower engines. Higher horsepower alternative fuel engines are beginning to be introduced. However, vehicle range, lack of experience with alternative fuel engine technologies and limited selection of appropriate alternative fuel engine products have made it difficult for more firms to consider significant use of alternative fuel vehicles. For example, in recent years, several large trucking fleets have expressed interest in using alternative fuels. However, at this time the choice of engines over 350 HP or more is limited. Continued development of cleaner dedicated natural gas or other alternative fuel engines such as natural gas-hydrogen blends over 350 HP would increase availability to end-users and provide additional emission reductions.

Potential Air Quality Benefits:

This program is intended to expedite the commercialization of low emission alternative fuel heavy-duty engine technology in California, both in the Basin and in intrastate operation. The emission reduction benefit of replacing one 4.0 g/bhp-hr heavy-duty engine with a 0.2 g/bhp-hr engine in a vehicle that consumes 10,000 gallons of fuel per year is about 1400 lb/yr of NO_x. Clean alternative fuels, such as natural gas, or natural gas blends with hydrogen can also reduce heavy-duty engine particulate emissions by over 90 percent compared to current diesel technology. This program is expected to lead to increased availability of low emission alternative fuel heavy-duty engines. Fleets can use the engines and vehicles emerging from this program to comply with SCAQMD fleet regulations.

Proposed Project: Develop and Demonstrate Alternative Fuel and Clean Conventional Fueled Light-Duty Vehicles

Expected SCAQMD Cost: \$200,000

Expected Total Cost: \$1,500,000

Description of Technology and Application:

Although new conventional fueled vehicles are much cleaner than their predecessors, not all match the lowest emissions standards often achieved by alternative fuel vehicles. This project would assist in the development, demonstration and certification of both alternative-fueled and conventional-fueled vehicles to meet the strictest emissions requirements by the state, e.g., SULEV for light-duty vehicles. The candidate fuels include CNG, LPG, ethanol, GTL, clean diesel, bio-diesel and ultra low-sulfur diesel, and compressed air technologies. The potential vehicle projects may include:

- certification of CNG light-duty sedans and pickup trucks used in fleet services;
- resolution of higher concentration ethanol (E-85) affect on vehicle fueling system (“permeation issue”);
- certification of E85 vehicles to SULEV standards;
- assessment of “clean diesel” vehicles, including hybrids and their ability to attain SULEV standards; and
- assessment of compressed air technologies.

Other fuel and technology combinations may also be considered under this category.

Potential Air Quality Benefits:

The 2012 AQMP identifies the use of alternative clean fuels in mobile sources as a key attainment strategy. Pursuant to AQMP goals, the SCAQMD has in effect several fleet rules that require public and certain private fleets to purchase clean-burning alternative-fueled vehicles when adding or replacing vehicles to their vehicle fleets. This program is expected to lead to increased availability of low emission alternative-and conventional-fueled vehicles for fleets as well as consumer purchase.

Infrastructure and Deployment (NG)

Proposed Project: Deploy Natural Gas Vehicles in Various Applications

Expected SCAQMD Cost: \$500,000

Expected Total Cost: \$2,000,000

Description of Technology and Application:

Natural gas vehicles (NGVs) have been very successful in reducing emissions in the South Coast Air Basin due to the deployment of fleets and heavy-duty vehicles utilizing this clean fuel. In order to maintain the throughput, utility and commercial potential of the natural gas infrastructure and the corresponding clean air benefits, deploying additional models of NGVs in existing applications are needed. This technology category seeks to support the implementation of early-commercial vehicles in a wide variety of applications, such as taxis, law enforcement vehicles, shuttle buses, delivery vans, transit buses, waste haulers, class 8 tractors and off-road equipment such as construction vehicles and yard hostlers.

Potential Air Quality Benefits:

Natural gas vehicles have inherently lower engine criteria pollutant emissions than conventional vehicles, especially in the heavy-duty applications where older diesel engines are being replaced. Incentivizing these vehicles in city fleets, goods movement applications and transit bus routes help to reduce the local emissions and exposure to nearby residents. Natural gas vehicles also can have lower greenhouse gas emissions and increase energy diversity depending on the feedstock and vehicle class. Deployment of additional NGVs is in agreement with SCAQMD's AQMP as well as the state's Alternative Fuels Plan as part of AB 1007 (Pavley).

Proposed Project: Develop, Maintain & Expand Natural Gas Infrastructure

Expected SCAQMD Cost: \$300,000

Expected Total Cost: \$2,000,000

Description of Technology and Application:

This program would support the development, maintenance and expansion of natural gas fueling station technologies and incorporate advancing concepts to increase the overall number of such fueling stations in strategic locations throughout the Basin including the Ports, reduce the cost of natural gas equipment, standardize fueling station design and construction and help with the implementation of SCAQMD's fleet rules. As natural gas fueling equipment begins to age or has been placed in demanding usage, components begin to age and deteriorate. This program offers an incentive to facilities to replace worn-out equipment or to upgrade existing fueling and/or garage and maintenance equipment to offer increased fueling capacity to public agencies, private fleets and school districts.

Potential Air Quality Benefits:

The AQMP identifies the use of alternative clean fuels in mobile sources as a key attainment strategy. NGVs have significantly lower emissions than gasoline vehicles and represent the cleanest internal combustion engine powered vehicles available today. The project has the potential to significantly reduce the installation and operating costs of NGV refueling stations, besides improving the refueling time. While new or improved NGV stations have an indirect emissions reduction benefit, they help facilitate the introduction of low emission, NGVs in private and public fleets in the area, which have a direct emissions reduction benefit. The increased exposure and fleet and consumer acceptance of NGVs would lead to significant and direct reductions in NO_x, VOC, CO, PM and toxic compound emissions from mobile sources. Such increased penetration of NGVs will provide direct emissions reductions of NO_x, VOC, CO, PM and air toxic compounds throughout the Basin.

Proposed Project: Demonstrate Natural Gas Manufacturing and Distribution Technologies Including Renewables

Expected SCAQMD Cost: \$500,000

Expected Total Cost: \$7,000,000

Description of Technology and Application:

Lack of sufficient statewide LNG production results in increased fuel costs and supply constraints. The cost of transporting LNG from production facilities out-of-state increases the fuel cost anywhere from 15 to 20 cents per gallon of LNG and subjects users to the reliability of a single supply source. High capital costs prevent construction of closer, large scale liquefaction facilities. Small-scale, distributed LNG liquefaction systems may provide 25 percent lower capital costs than conventional technology per gallon of LNG produced. Because these smaller plants can be sited near fleet customers, costs for transporting the LNG to end users are much lower than those for remote larger plants. Beyond these cost reductions, the smaller plants offer key benefits of much smaller initial capital investment and wider network of supply than the larger plant model. Renewable feed stocks including landfill gas, green waste and waste gases can be processed to yield LNG or CNG.

Industry and government agree that LNG promises to capture a significant share of the heavy-duty vehicle and engine market. LNG is preferred for long distance trucking as it provides twice the energy per unit volume as CNG. This translates to longer driving ranges and lower-weight vehicle fuel storage.

The main objectives of this project are to investigate, develop and demonstrate:

- commercially viable methods for converting renewable feed stocks into CNG or LNG (e.g., production from biomass);
- economic small-scale natural gas liquefaction technologies;
- utilization of various gaseous feed stocks locally available;
- commercialize incentives for fleets to site, install and use LNG and L/CNG refueling facilities; and
- strategic placement of LNG storage capacity sufficient to provide supply to users in the event of a production outage.

Potential Air Quality Benefits:

The SCAQMD relies on a significant increase in the penetration of zero- and low emission vehicles in the South Coast Basin to attain federal clean air standards by 2014, 2023 and 2032. This project would help develop a number of small-scale liquefaction technologies that can reduce LNG costs to be competitive with diesel fuel. Such advances are expected to lead to greater infrastructure development. This would make LNG fueled heavy-duty vehicles more available to the commercial market leading to direct reductions in NO_x, PM and toxic compound emissions.

Fuels/Emission Studies

Proposed Project: In-Use Emissions Studies for Advanced Technology Vehicle Demonstrations

Expected SCAQMD Cost: \$500,000

Expected Total Cost: \$1,000,000

Description of Technology and Application:

Hybrid electric, hybrid hydraulic, plug-in electric hybrid and pure EVs will all play a unique role in the future of transportation. Each of these transportation technologies has attributes that could provide unique benefits to different transportation sectors. Identifying the optimal placement of each transportation technology will provide the co-benefits of maximizing the environmental benefit and return on investment for the operator.

The environmental benefit for each technology class will be highly duty-cycle and application specific. Identifying the attributes of a specific application or drive cycle that would take best advantage of a specific transportation technology would speed the adoption and make optimal use of financial resources in the demonstration and deployment of a technology. The adoption rates would be accelerated since the intelligent deployment of a certain technology would ensure that a high percentage of the demonstration vehicles showed positive results. These positive results would spur the adoption of this technology in similar applications, as opposed to negative results derailing the further development or deployment of a certain technology.

The proposed project would conduct a characterization of application specific drive cycles to best match different transportation technologies to specific applications. The potential emissions reductions and fossil fuel displacement for each technology in a specific application would be quantified on a full-cycle basis. This information could be used to develop a theoretical database of potential environmental benefits of different transportation technologies when deployed in specific applications.

Potential Air Quality Benefits:

The development of an emissions reduction database, for various application specific transportation technologies, would assist in the targeted deployment of new transportation technologies. This database coupled with application specific vehicle miles traveled and population data would assist in intelligently deploying advanced technology vehicles to attain the maximum environmental benefit. These two data streams would allow vehicle technologies to be matched to an application that is best suited to the specific technology, as well as selecting applications that are substantial enough to provide a significant environmental benefit. The demonstration of a quantifiable reduction in operating cost through the intelligent deployment of vehicles will also accelerate the commercial adoption of the various technologies. The accelerated adoption of lower emitting vehicles will further assist in attaining SCAQMD's air quality goals.

Proposed Project: Conduct Emissions Studies on Biofuels and Alternative Fuels

Expected SCAQMD Cost: \$500,000

Expected Total Cost: \$1,300,000

Description of Technology and Application:

The use of biofuels can be an important strategy to reduce petroleum dependency, air pollution and greenhouse gas emissions. Biofuels are in fact receiving increased attention due to national support and state activities resulting from AB 32, AB 1007 and the Low-Carbon Fuel Standard. It's noteworthy to mention that last year the Low-Carbon Fuel Standard was upheld by the U.S. Court of Appeals for the Ninth Circuit last year and more recently opponents were denied further appeal by the Supreme Court. With an anticipated increase in biofuel use, it is the objective of this project to further analyze these fuels to better understand their benefits and impacts not only on greenhouse gases but also on air pollution and associated health effects.

In various diesel engine studies, replacement of petroleum diesel fuel with biodiesel fuel has demonstrated reduced PM, CO and air toxics emissions. Biodiesel also has the potential to reduce greenhouse gas emissions because it can be made from renewable feedstocks, such as soy and canola. However, certain blends of biodiesel have a tendency to increase NO_x emissions, which exacerbates the ozone and PM_{2.5} challenges faced in the Basin. In addition, despite recent advancements in toxicological research in the air pollution field, the relationship between biodiesel particle composition and associated health effects is still not completely understood.

Ethanol is another biofuel that is gaining increased national media and state regulatory attention. CARB has recently amended the reformulated gasoline regulation to further increase the ethanol content to 10% as a means to increase the amount of renewable fuels in the state. It is projected that the state's ethanol use will increase from 900 million gallons in 2007 to 1.5 billion gallons by 2012 as a result. As in the case of biodiesel, ethanol has demonstrated in various emission studies to reduce PM, CO and toxic emissions; however, the relationship between particle composition and associated health effects from the combustion of ethanol is not well understood either.

DME is another fuel which requires evaluation of in-use emissions, especially NO_x, in light of Volvo's announcement that they will commercialize class 8 trucks using DME in 2015. The impact of natural gas fuel composition on emissions from heavy-duty trucks and transit buses is also being studied.

In order to address these concerns on potential health effects associated with biofuels, namely biodiesel and ethanol blends, this program will investigate the physical and chemical composition and associated health effects of tailpipe PM emissions from light- to heavy-duty vehicles burning biofuels in order to ensure public health is not adversely impacted by broader use of these fuels. This program also supports future studies to identify mitigation measures to reduce NO_x emissions for biofuels. Additionally, a study of emissions from well-to-wheel for the extraction and use of shale gas might be considered.

Potential Air Quality Benefits:

If biodiesel and biodiesel blends can be demonstrated to reduce air pollutant emissions with the ability to mitigate any NO_x impact, this technology will become a viable strategy to assist in meeting air pollutant standards as well as the goals of AB 32 and the Low-Carbon Fuel Standard. The use of biodiesel is an important effort for a sustainable energy future. Emission studies are critical to understanding the emission benefits and any tradeoffs (NO_x impact) that may result from using this alternative fuel. With reliable information on the emissions from using biodiesel and biodiesel blends, the SCAQMD can take actions to ensure the use of biodiesel will obtain air

pollutant reductions without creating additional NO_x emissions that may exacerbate the Basin's ozone problem.

Proposed Project: Identify and Demonstrate In-Use Fleet Emissions Reduction Technologies and Opportunities

Expected SCAQMD Cost: \$250,000

Expected Total Cost: \$2,000,000

Description of Technology and Application:

New technologies, such as alternative fueled heavy-duty engines, are extremely effective at reducing emissions because they are designed to meet the most stringent emissions standards while maintaining vehicle performance. In addition, many new vehicles are now equipped with telematics enabling motorists to obtain transportation information such as road conditions to avoid excessive idling and track information about the vehicle maintenance needs, repair history, tire pressure and fuel economy. Telematics have been shown to reduce emissions from new vehicles. Unfortunately, the in-use fleet lacks telematic systems--particularly heavy-duty engines in trucks, buses, construction equipment, locomotives, marine vessels and cargo handling equipment--have fairly long working lifetimes (up to 20 years due to remanufacturing in some cases). Even light-duty vehicles routinely have lifetimes exceeding 200,000 miles and 10 years. And it is the in-use fleet, especially the oldest vehicles, which are responsible for the majority of emissions.

This project category is to investigate near-term emissions control technologies which can be economically applied to reduce emissions from the in-use fleet. The first part of the project is to identify and conduct proof-of-concept demonstrations of feasible candidate technologies, such as:

- remote sensing for heavy-duty vehicles;
- annual testing for high mileage vehicles (>100,000 miles);
- replace or upgrade emissions control systems at 100,000 mile intervals;
- on-board emission diagnostics with remote notification;
- low-cost test equipment for monitoring and identifying high emitters;
- test cycle development for different class vehicles (e.g. four wheel drive SUVs);
- electrical auxiliary power unit replacements; and
- development, deployment and demonstration of smart vehicle telematic systems

The second phase of the project is to validate the technology or strategy on a larger demonstration project over a longer period of time.

Potential Air Quality Benefits:

Many of the technologies identified can be applied to light-duty and heavy-duty vehicles to identify and subsequently remedy high-emitting vehicles in the current fleet inventory. Estimates suggest that 5 percent of existing fleets account for up to 80 percent of the emissions. Identification of higher emitting vehicles would assist with demand-side strategies, where higher emitting vehicles have correspondingly higher registration charges.

Health Impacts Studies

Proposed Project: Evaluate Ultrafine Particle Health Effects

Expected SCAQMD Cost: \$250,000

Expected Total Cost: \$3,000,000

Description of Technology and Application:

Reducing diesel exhaust from vehicles has become a high priority in the South Coast Air Basin since CARB identified the particulate phase of diesel exhaust as a surrogate for all of the toxic air contaminant emitted from diesel exhaust. Additionally, recent health studies indicate that the ultrafine portion of particulate matter may be more toxic on a per-mass basis than other fractions. Several technologies have been introduced and others are under development to reduce diesel emissions. These include among others low-sulfur diesel fuel, particulate matter traps and heavy-duty engines operating on alternative fuel such as CNG and LNG. Recent studies have shown that control technologies applied to mobile sources have been effective in reducing the mass of particulates emitted. However, there is also evidence that the number of ultrafine particles on and near roadways has increased, even while the mass of particulates has decreased. To have a better understanding of changes in ultrafine particulate emissions from the application of the new technologies and the health effects of these emissions, an evaluation and comparison of ultrafine particulate matter and the potential impacts on community exposures are necessary.

In this project, measurements and chemical composition of ultrafine particulates will be done, as well as studies conducted to characterize their toxicity. The composition of the particulates can further be used to determine the contribution from specific combustion sources. Additionally, engine or chassis dynamometer testing may be conducted on heavy-duty vehicles to measure, evaluate and compare ultrafine particulate matter, PAH and other relevant toxic emissions from different types of fuels such as CNG, low-sulfur diesel, biofuels and others. This project needs to be closely coordinated with the development of technologies for alternative fuels, aftertreatment and new engines in order to determine the health benefits of such technologies.

Potential Air Quality Benefits:

The AQMP for the South Coast Basin relies on significant penetration of low emission vehicles to attain federal clean air standards. Reduction of particulate emissions from the combustion of diesel and other fuels is a major priority in achieving these standards. This project would help to better understand the nature and amount of ultrafine particulates generated by different types of fuels and advanced control technologies as well as provide information on potential health effects of ultrafine particles. Such an understanding is important to assess the emission reduction potentials and health benefits of these technologies. In turn, this will have a direct effect on the policy and regulatory actions for commercial implementation of alternative fuel vehicles in the Basin.

Proposed Project: Conduct Monitoring to Assess Environmental Impacts

Expected SCAQMD Cost: \$250,000

Expected Total Cost: \$1,000,000

Description of Technology and Application:

Facilities, buildings, structures, or highways which attract mobile sources of pollution are considered “indirect” sources. Ambient and saturation air monitoring near sources such as ports, airports, rail yards, distribution centers and freeways is important to identify the emissions exposure to the surrounding communities and provide the data to then conduct the health impacts due to these sources. This project category would identify areas of interest and conduct ambient air monitoring, conduct emissions monitoring, analyze the data and assess the potential health impacts from mobile sources. The projects would need to be at least one year in duration in order to properly assess the air quality impacts in the area.

Potential Air Quality Benefits:

The proposed project will assist in the evaluation of adverse public health impacts associated with mobile sources. The information will be useful in (a) determining whether indirect sources have a relatively higher impact on residents living in close proximity; and (b) providing guidance to develop some area-specific control strategies in the future should it be necessary.

Proposed Project: Assess Sources and Health Impacts of Particulate Matter

Expected SCAQMD Cost: \$250,000

Expected Total Cost: \$300,000

Description of Technology and Application:

Previous studies of ambient levels of toxic air contaminants, such as the MATES series of studies, have found that diesel exhaust is the major contributor to health risk from air toxics. Analyses of diesel particulate matter in ambient samples have been based on measurements of elemental carbon. While the bulk of particulate elemental carbon in the South Coast Air Basin is thought to be from combustion of diesel fuels, it is not a unique tracer for diesel exhaust.

The MATES III study collected particulate samples at ten locations in the South Coast Air Basin. Analysis of particulate bound organic compounds was utilized as tracers to estimate levels of ambient diesel particulate matter as well as estimate levels of particulate matter from other major sources. Other major sources that were taken into consideration include automobile exhaust, meat charbroiling, road dust, wood smoke and fuel oil combustion. Analyzing for organic compounds and metals in conjunction with elemental carbon upon collected particulate samples was used to determine contributing sources.

MATES IV was initiated in mid-2012 and includes an air monitoring program, an updated emissions inventory of toxic air contaminants and a regional modeling effort to characterize risk across the Basin. The draft report was released for public review in October 2014. In addition to air toxics, MATES IV also measured ultrafine particle concentrations and black carbon at the monitoring sites as well as near sources such as airports, freeways, rail yards, busy intersections and warehouse operations.

This project category would include other related studies, such as toxicity assessment based on age, source (heavy-duty, light-duty engines) and composition (semi-volatile or non-volatile fractions) to better understand the health effects and potential community exposures.

Potential Air Quality Benefits:

Results of this work will provide a more robust, scientifically sound estimate of ambient levels of diesel particulate matter as well as levels of particulate matter from other significant combustion sources. This will allow a better estimation of potential exposures to and health effects from toxic air contaminants from diesel exhaust in the South Coast Air Basin. This information in turn can be used to determine the health benefits of promoting clean fuel technologies.

Stationary Clean Fuel Technologies

Proposed Project: Develop and Demonstrate Reliable, Low Emission Monitoring Systems and Test Methods

Expected SCAQMD Cost: \$250,000

Expected Total Cost: \$500,000

Description of Technology and Application:

Currently, the inability of air/fuel ratio control (AFRC) systems to keep rich-burn engines in compliance contributes significantly to air pollution in the basin. Reliable, low-cost emission monitoring systems are needed for small-to-intermediate size combustion devices, including stationary engines, boilers, heaters, furnaces and ovens that are not large enough to justify a continuous emission monitoring system (CEMS). This class of combustion device is often permitted on the basis of a single demonstration or periodic demonstrations of NO_x and CO emissions meeting SCAQMD rule requirements or a RECLAIM concentration limit. However, SCAQMD-unannounced tests on engines and boilers have found that in many cases NO_x and/or CO levels have increased significantly above levels that have been initially or periodically demonstrated due to equipment malfunction and/or inadequate operator attention. It is suspected that the same may be true of heaters, furnaces and ovens.

Demonstrations of newer technologies in recent years could result in a commercially viable alternative to CEMs that is both reliable and feasible in terms of lower costs. For example, manufacturers of flue gas analyzers have, in recent years, developed low-cost multi-gas analyzers suitable for portable or stack-mounted use. Some preliminary testing of a new type of AFRC, which uses a different type of O₂ sensor known as a wide-band O₂ sensor, is another alternative that can be analyzed. Another technical approach might be to deploy technology utilizing the O₂ signature of a post-catalyst O₂ sensor and additional control concepts being developed by manufacturers. Since an underlying problem has been that engine, catalyst and AFRC manufacturers have developed systems independently, a system being co-developed to perform continuous diagnostics to assist operators in keeping rich-burn engines in compliance is possibly another alternative for demonstration.

Potential Air Quality Benefits:

Stationary engines, boilers, heaters, furnaces and ovens account for approximately 11 percent of total NO_x emissions and about 6 percent of total CO emissions. There has been a long-standing compliance problem with rich-burn IC engines in the basin and evidence indicates that many of these devices are operating with NO_x and/or CO emissions above levels required in their permits. Projects could potentially reduce a significant class of NO_x and CO emissions that are in excess of the assumptions in the AQMP and further enhance SCAQMD's ability to enforce full-time compliance.

Proposed Project: Develop and Demonstrate Clean Stationary Technologies

Expected SCAQMD Cost: \$250,000

Expected Total Cost: \$750,000

Description of Technology and Application:

Stationary sources, including VOC sources such as large printing facilities and furniture manufacturers, have become cleaner and cleaner due to the regulatory requirements for low emissions and the advancements in technology to meet those requirements. Best Available Control Technology (BACT) regulations, however, are only required for new, modified, or relocated sources. This project category is to develop and demonstrate new technologies that can provide emissions reductions in new installations or as retrofit modifications. Possible technology examples include:

- low NO_x technologies (burners and ICEs);
- low-Btu gas technologies (e.g., digester, landfill, or dairy gases);
- alternative fuels and hydrogen blends;
- alternative diesel fuels (emulsified, gas-to-liquids, biodiesel with aftertreatment);
- low emission refinery flares;
- catalytic combustion;
- cost-effective fuel cell and fuel cell hybrid distributed generation;
- fumes-to-fuel technology to replace thermal oxidizers and capture VOC emissions for electricity generation while ensuring no emission of air toxics; and
- boiler optimization design and strategies to improve efficiencies.

Depending on the technology, a proof-of-concept project, demonstration, or pre-commercial deployment would be considered to garner further information on the technology. Issues to investigate include viability (reliability, maintainability and durability) of the technology, cost-effectiveness and operator ease-of-use in order to assess commercialization.

Potential Air Quality Benefits:

The SCAQMD has a substantial number of older, small, stationary source technologies within its jurisdiction. Since these devices are not subject to continuous emissions monitoring system requirements, evidence suggests that these devices may not be operating at their permitted NO_x, CO, hydrocarbon and PM emissions levels. Replacing these devices with cleaner and more reliable technologies or technology/fuel combinations can have dramatic reductions in all of these criteria pollutants. VOC emission reductions may also be achieved at larger stationary VOC sources to achieve the new federal ozone and PM_{2.5} standards.

Proposed Project: Develop and Demonstrate Renewables-Based Energy Generation Alternatives

Expected SCAQMD Cost: \$200,000

Expected Total Cost: \$1,000,000

Description of Technology and Application:

The objective of this proposed program is to support the development and demonstration of clean energy, renewable alternatives in stationary and mobile applications. The technologies to be considered include thermal, photovoltaic and other solar energy technologies; wind energy systems; energy storage and conservation potentially including vehicle to grid or vehicle to building functionalities for alternative energy storage; biomass conversion; and other renewable energy and recycling technologies. Innovative solar technologies, such as solar thermal air conditioning and photovoltaic-integrated roof shingles, are of particular interest. Also, in the agricultural sections of the Basin, wind technologies could potentially be applied to drive large electric motor-driven pumps to replace highly polluting diesel-fired pumps. Besides renewable technologies, electrolyzer technology could be used to generate hydrogen, a clean fuel. Hydrogen, when used in regular engines, can substantially reduce tail-pipe emissions, while in fuel cells the emissions are reduced to zero.

The project is expected to result in pilot-scale production demonstrations, scale-up process design and cost analysis, overall environmental impact analysis and projections for ultimate clean fuel costs and availability. This program is expected to result in several projects addressing technological advancements in these technologies that may improve performance and efficiency, potentially reduce capital and operating costs, enhance the quality of natural gas generated from renewable sources for injection into natural gas pipelines, improve reliability and user friendliness and identify markets that could expedite the implementation of successful technologies.

Potential Air Quality Benefits:

The 2012 AQMP identifies the development and ultimately the implementation of non-polluting power generation. To gain the maximum air quality benefit, polluting fossil fuel-fired electric power generation needs to be replaced with clean renewable energy resources or other advanced zero emission technologies, such as hydrogen fuel cells, particularly in a distributed generation context.

The proposed program is expected to accelerate the implementation of advanced zero emission energy sources. Expected benefits include directly reducing the emissions by the displacement of fossil generation; proof-of-concept and potential viability for such zero emission power generation systems; increased exposure and user acceptance of the new technology; reduced fossil fuel usage; and the potential for increased use, once successfully demonstrated, with resulting emission benefits, through expedited implementation. These technologies would also have a substantial influence in reducing global warming emissions.

Emission Control Technologies

Proposed Project: Develop and Demonstrate Advanced Aftertreatment Technologies

Expected SCAQMD Cost: \$300,000

Expected Total Cost: \$5,000,000

Description of Technology and Application:

There are a number of aftertreatment technologies which have shown substantial emission reductions in diesel engines. These technologies include diesel particulate filters (DPFs), oxidation catalysts, selective catalytic reduction (SCR) systems and NO_x adsorbers. This project category is to develop and demonstrate these aftertreatment technologies alone or in tandem with an alternative fuel to produce the lowest possible PM, ultrafine particles, nanoparticles, NO_x, CO, carbonyl and hydrocarbon emissions in retrofit and new applications. With the increasing focus on zero- and near-zero emission goods movement technologies, this category should examine idle reduction concepts and technologies that can be employed at ports and airports.

Possible projects include advancing the technologies for on-road retrofit applications such as heavy-duty line-haul diesel engines, street sweepers, waste haulers and transit buses. Applications for non-road may include construction equipment, yard hostlers, gantry cranes, locomotives, marine vessels, ground support equipment and other similar industrial applications. Potential fuels to be considered in tandem are low-sulfur diesel, emulsified diesel, biodiesel, gas-to-liquids, hydrogen and natural gas. This project category will also explore the performance, economic feasibility, viability (reliability, maintainability and durability) and ease-of-use to ensure a pathway to commercialization.

Potential Air Quality Benefits:

The transfer of mature emission control technologies, such as DPFs and oxidation catalysts, to the off-road sector is a potentially low-risk endeavor that can have immediate emissions reductions. Further development and demonstration of other technologies, such SCR and NO_x adsorbers, could also have NO_x reductions of up to 90%.

Proposed Project: Demonstrate On-Road Technologies in Off-Road and Retrofit Applications

Expected SCAQMD Cost: \$250,000

Expected Total Cost: \$1,000,000

Description of Technology and Application:

Heavy-duty on-road engines have demonstrated progress in meeting increasingly stringent Federal and state requirements. New heavy-duty engines have progressed from 2 g/bhp-hr NO_x in 2004 to 0.2 g/bhp-hr NO_x in 2010, which is an order of magnitude decrease in just six years. Off-road engines, however, have considerably higher emissions limits depending on the engine size. For example, Tier-3 standards for heavy-duty engines require only 3 g/bhp-hr NO_x. There are apparent opportunities to implement cleaner on-road technologies in off-road applications. There is also an opportunity to replace existing engines in both on-road and off-road applications with the cleanest available technology. Current regulations require a repower (engine exchange) to only meet the same emissions standards as the engine being retired. Unfortunately, this does not take advantage of recently developed clean technologies.

Exhaust gas cleanup strategies, such as SCR, electrostatic precipitators, baghouses and scrubbers, have been used successfully for many years on stationary sources. The exhaust from the combustion source is routed to the cleaning technology, which typically requires a large footprint for implementation. This large footprint has made installation of such technologies on some mobile sources prohibitive. However, in cases where the mobile source is required to idle for long periods of time, it may be more effective to route the emissions from the mobile source to a stationary device to clean the exhaust stream.

Projects in this category will include utilizing proven clean technologies in novel applications, such as:

- demonstrating certified LNG and CNG on-road engines in off-road applications including yard hostlers, switcher locomotives, gantry cranes, waste haulers and construction equipment;
- implementing lower emission engines in repower applications for both on-road and off-road applications; and
- application of stationary best available control technologies, such as SCR, scrubbers, baghouses and electrostatic precipitators, to appropriate on- and off-road applications, such as idling locomotives, marine vessels at dock and heavy-duty line-haul trucks at weigh stations.

Potential Air Quality Benefits:

The transfer of mature emission control technologies, such as certified engines and SCR, to the non-road and retrofit sectors offers high potential for immediate emissions reductions. Further development and demonstration of these technologies will assist in the regulatory efforts which could require such technologies and retrofits.

Outreach and Technology Transfer

Proposed Project: Assessment and Technical Support of Advanced Technologies and Information Dissemination

Expected SCAQMD Cost: \$500,000

Expected Total Cost: \$800,000

Description of Project:

This program supports the assessment of clean fuels and advanced technologies, their progress towards commercialization and the dissemination of information on demonstrated technologies. The objective of this program is to expedite the transfer of technology developed as a result of Technology Advancement Office projects to the public domain, industry, regulatory agencies and the scientific community. This program is a fundamental element in the SCAQMD's outreach efforts to expedite the implementation of low emission and clean fuels technologies and to coordinate these activities with other organizations.

This program may include the following:

- technical review and assessment of technologies, projects and proposals;
- support for alternative fuel refueling and infrastructure;
- advanced technology curriculum development, mentoring and outreach to local schools;
- emissions studies and assessments of zero emission alternatives;
- advanced technology vehicle demonstrations;
- preparation of reports, presentations at conferences, improved public relations and public communications of successful demonstrations of clean technologies;
- participation in and coordination of workshops and various meetings;
- support for training programs related to fleet operation, maintenance and refueling of alternative fuel vehicles;
- publication of technical papers, reports and bulletins; and
- production and dissemination of information, including web sites.

These objectives will be achieved by consulting with industry, scientific, health, medical and regulatory experts and co-sponsoring related conferences and organizations, resulting in multiple contracts. In addition, an ongoing outreach campaign will be conducted to encourage decision-makers to voluntarily switch to alternatively fueled vehicles and train operators to purchase, operate and maintain these vehicles and associated infrastructure.

Potential Air Quality Benefits:

SCAQMD adopted fleet regulations requiring public and private fleets within the Basin to acquire alternatively fueled vehicles when making new purchases. Expected benefits of highlighting success stories in the use of advanced alternatively fueled vehicles could potentially expedite the acceptance and commercialization of advanced technologies by operators seeking to comply with the provisions of the recently adopted SCAQMD fleet rules. The resulting future emissions benefits will contribute to the goals of the AQMP.

Proposed Project: Support for Implementation of Various Clean Fuels Vehicle Incentive Programs

Expected SCAQMD Cost: \$400,000

Expected Total Cost: \$400,000

Description of Project:

This program supports the implementation of zero emission vehicle incentive programs, the Carl Moyer incentives program and the school bus incentives program. Implementation support includes application approval, grant allocation, documentation to the CARB, verification of vehicle registration and other support as needed. Information dissemination is critical to successful implementation of a coordinated and comprehensive package of incentives. Outreach will be directed to vehicle dealers, individuals and fleets.

Potential Air Quality Benefits:

As described earlier, the SCAQMD will provide matching funds to implement several key incentives programs to reduce diesel emissions in the Basin. Furthermore, the SCAQMD recently adopted fleet regulations requiring public and private fleets within the Basin to acquire alternatively fueled vehicles when making new purchases. Expected benefits of highlighting zero emission vehicle incentives could potentially expedite the acceptance and commercialization of advanced technologies by operators seeking to comply with the provisions of the recently adopted SCAQMD fleet rules. The resulting future emissions benefits will contribute to the goals of the AQMP. The school bus program and the Carl Moyer incentives program will also reduce large amounts of NO_x and PM emissions in the basin in addition to reducing toxic air contaminants.

Appendix A
SCAQMD Advisory Groups

Technology Advancement Advisory Group

Dr. Matt Miyasato, Chair	SCAQMD
*Fabiola P. Lao	Coalition for Clean Air
Alberto Ayala.....	California Air Resources Board
Patrick Davis.....	U.S. Department of Energy
Dr. John Froines.....	Professor Emeritus University of California, Los Angeles
Gretchen Hardison	Los Angeles Department of Water and Power; Chair of Technical Advisory Committee of the Mobile Source Air Pollution Reduction Review Committee
Ed Kjaer	Southern California Edison
Philip J. Hodgetts	Clean Air Now
Randall Lewis	Lewis Group of Companies
Tim Olson	California Energy Commission
*Pending	Western States Petroleum Association
Cherif Youssef	Southern California Gas Company

*Newly appointed members

SB 98 Clean Fuels Advisory Group

Dr. Matt Miyasato, Chair SCAQMD

Robert Bienenfeld American Honda Motor Company Inc

Dr. Blair Folsom Independent Consultant in Combustion Technology

Dr. Mridul Gautam..... West Virginia University, Adjunct Professor, &
University of Nevada-Reno

Dr. Fritz Kalhammer Independent Consultant in Energy and Process
Technology

Dr. Melanie Marty California Environmental Protection Agency,
Office of Environmental Health Hazard Assessment

Dr. Wayne Miller University of California, Riverside,
College of Engineering, Center for Environmental
Research and Technology

Dr. Vernon Roan..... University of Florida, Professor Emeritus

Dr. Scott Samuelson..... University of California, Irvine,
Combustion Laboratory/National Fuel Cell
Research Center

Dr. Robert Sawyer Sawyer Associates

Kevin Walkowicz..... National Renewable Energy Laboratory

Dr. Nicholas Vanderborgh Independent Consultant in Fuel Cell Technologies

Michael Walsh Independent Consultant in Motor Vehicle Pollution
Control

*Newly appointed members

Appendix B

Open Clean Fuels Contracts as of January 1, 2015

Contract	Contractor	Project Title	Start Term	End Term	SCAQMD \$	Project Total \$
Infrastructure and Deployment						
05250	Downs Commercial Fueling, Inc.	Purchase & Install New L/CNG Fueling System at Commercial Fueling Station in Temecula	11/04/05	04/30/16	\$203,137	\$833,333
06042	University of California Los Angeles	Upgrade Existing CNG Public Access Station with Dispenser & Card Reader	09/05/06	12/31/16	15,921	31,842
06084	Clean Energy	Upgrade Existing LNG Facility to L/CNG at Riverside County Waste Management Dept's Aqua Mansa Facility in Riverside	04/13/06	02/28/16	120,000	400,000
06091	City of Whittier	Purchase & Install New Public Access CNG Fueling Station at City Yard	03/18/06	12/31/16	150,000	450,000
07153	Foothill Transit	Purchase & Install New Public Access CNG Refueling Station in Irwindale	11/02/09	06/30/16	250,000	3,350,000
07243	City of Commerce	Purchase & Install New Public Access L/CNG Station	05/16/07	12/31/15	250,000	1,300,000
07246	USA Waste of California, Inc., dba L.A. Metro	Purchase & Install New LNG Storage Tank at Long Beach LNG Refueling Station	12/24/08	06/30/17	200,000	440,000
07320	Orange County Transportation Authority	Install New CNG Station in the City of Santa Ana	12/21/07	03/31/16	350,000	5,841,729
08043	University of California Los Angeles	Public Access CNG Refueling Station Upgrade for UCLA Transportation	05/02/08	12/31/16	140,000	350,000
08044	Beaumont Unified School District	Install Limited Access CNG Refueling Station	03/05/09	12/31/16	288,000	615,994
08098	Redlands Unified School District	Purchase & Install New CNG Refueling Station	01/25/08	12/31/17	525,000	700,000
09165	California Cartage Company	Deployment of 2010 Emissions Standards Compliant LNG Trucks	10/31/08	07/31/16	358,000	11,880,000
09218	Rim of the World Unified School District	Install Mountain Safety Equipment on Five New CNG School Buses	01/05/10	12/31/16	65,850	65,850
09364	Rim of the World Unified School District	Construct & Install a CNG Fueling Station	12/30/10	03/31/15	257,000	425,000
10067	Rim of the World Unified School District	Install Mountain Safety Equipment on Seven New CNG School Buses	12/21/09	12/31/16	92,190	92,190
11548	Clean Energy (novated from Mansfield Gas Equipment Systems)	Buydown Incentive Program for CNG Home Refueling Appliance "Phill"	09/07/12	06/30/15	60,000	356,000
12135	Placentia-Yorba Linda Unified School District	Upgrade CNG Fueling Station	11/18/11	11/30/17	60,000	60,000
12267	West Covina Unified School District	Upgrade CNG Fueling Facility	10/12/12	12/31/17	60,000	60,000
12851	Clean Energy	Install, Operate and Maintain Three LNG Fueling Stations (Fontana, Coachella and Perris)	10/05/12	12/31/18	1,400,000	4,277,323
12852	City of Covina	Construct Public Access CNG Fueling Stations	10/12/12	12/31/18	200,000	618,429
12853	Rainbow Disposal Co. Inc.	Upgrade CNG Fueling Station	03/08/13	12/31/18	200,000	400,000

Contract	Contractor	Project Title	Start Term	End Term	SCAQMD \$	Project Total \$
----------	------------	---------------	------------	----------	-----------	------------------

Infrastructure and Deployment

12854	Waste Management, Inc.	Upgrade LNG Fueling Station at Baldwin Park Facility	08/17/12	12/31/18	300,000	1,588,100
13401	Nite-Hawk Sweepers LLC	Demonstrate Natural Gas-Powered Parking Lot Sweepers	08/28/13	12/31/15	90,000	200,000
14219	City of West Covina	Upgrade CNG Station at City Yard	05/15/14	06/15/17	200,000	618,429
14311	Southern California Gas Company	Install and Maintain CNG Fueling Station in Murrieta for SoCalGas	07/11/14	12/31/17	217,000	1,385,000
15438	United Parcel Service, Inc.	Refurbish/Upgrade Ontario UPS LCNG Infrastructure	12/31/14	06/30/18	246,707	484,535

Fuels/Emission Studies

07236	National Renewable Energy Laboratory	Investigate the Role of Lubricating Oil on PM Emissions from Vehicles	03/23/07	12/30/15	200,000	446,887
10066	National Renewable Energy Laboratory	CRADA – Loan of 70 MPa Hydrogen Quality Sampling Apparatus to AQMD	11/02/09	12/30/15	0	0
10722	University of California Riverside/CE-CERT	Re-Establish Testing Facility & Quantify PM Emission Reductions from Charbroiling Operations	08/06/10	06/30/15	60,000	60,000
13402	University of California Davis-Office of Research	Next Sustainable Transportation Energy Pathways (STEPS) Program	05/02/14	07/01/16	120,000	2,760,000
14162	National Renewable Energy Laboratory	Utilization of Fleet DNA Approach and Capabilities to Provide Vehicle Vocational Analysis in SCAQMD	02/26/14	12/30/15	174,985	199,985

Electric/Hybrid Technologies

08063	Quantum Fuel Systems Technologies Worldwide, Inc.	Develop & Demonstrate 20 Plug-In Hybrid Electric Vehicles	01/22/08	12/31/15	2,165,613	2,885,266
08219	A123Systems Inc.	Develop & Demonstrate Ten Plug-In Hybrid Electric Vehicles	06/05/09	06/04/15	622,667	962,667
11204	AC Propulsion	Develop & Demonstrate Electric Drive Conversion for Fleet Vehicles	12/24/10	11/30/15	300,000	755,767
11606	Odyne Systems, LLC	Develop and Demonstrate Plug-In Hybrid Electric Drive System for Medium- and Heavy-Duty Vehicles	07/08/11	09/30/15	494,000	2,599,000
11615	Parker Hannifin Corporation	Develop & Demonstrate Up to Four Heavy-Duty Hydraulic Hybrid Vehicles	01/18/13	12/13/16	250,000	2,000,000
12028	Electric Vehicle International, Inc.	Demonstrate and Replace UPS Diesel Delivery Trucks with Zero-Emission Medium-Duty Trucks	09/09/11	09/08/17	1,400,000	4,872,000
12862	Volvo Technology of America, Inc.	Develop Class 8 Plug-In Hybrid Heavy-Duty Vehicle	12/07/12	07/31/15	1,200,000	2,400,000
13042	South Bay City Council of Governments	Demonstrate Medium-Speed Electric Vehicles	11/02/12	05/01/15	320,000	528,078
13058	Capstone Turbine Corporation	Develop Microturbine Series Hybrid System for Class 7 Heavy-Duty Vehicle Applications	08/12/13	03/30/16	360,000	1,210,000

Contract	Contractor	Project Title	Start Term	End Term	SCAQMD \$	Project Total \$
Electric/Hybrid Technologies & Infrastructure (cont'd)						
13251	Selman Chevrolet Company	Lease Two 2012 or Newer Chevrolet Volt Extended-Range Electric Vehicles for Three Years	11/28/12	05/01/15	31,375	31,375
13396	Transportation Power Inc.	Develop and Demonstrate Seven Class 8 Zero Emission Electric Trucks	04/19/13	12/31/16	375,000	2,285,368
13404	Penske Honda of Ontario	Lease Two Honda Fit Electric Vehicles for Three Years	05/02/13	05/01/16	31,307	31,307
13410	Selman Chevrolet Company	Lease Three 2013 Chevrolet Volt Extended-Range Electric Vehicles for Three Years	04/03/13	04/02/16	41,084	41,084
13418	City of Claremont	SoCalEV Infrastructure MOA to Install & Upgrade EV Charging Infrastructure	08/29/13	12/30/15	0	0
13419	California State University, Los Angeles	SoCalEV Infrastructure MOA to Install & Upgrade EV Charging Infrastructure	08/05/13	12/30/15	0	0
13420	University of California Irvine	SoCalEV Infrastructure MOA to Install & Upgrade EV Charging Infrastructure	08/28/13	12/30/15	0	0
13421	County of Los Angeles	SoCalEV Infrastructure MOA to Install & Upgrade EV Charging Infrastructure	09/06/13	12/15/14	0	0
13426	Transportation Power, Inc.	Develop & Demonstrate Catenary Class 8 Trucks (1 Electric & 1 CNG Platform)	06/07/13	06/06/16	2,617,887	3,182,795
13429	Longo Toyota	Lease One Toyota RAV4 Electric Vehicle for Three Years	04/19/13	04/18/16	19,618	19,618
13439	City of Carson	MOU for Catenary Zero Emission Goods Movement Project	10/01/13	09/30/16	0	0
14053	Electric Power Research Institute	PHEV Fleet Participation Agreement	10/01/13	07/31/15	0	0
14062	Siemens Industry Inc.	Develop and Demonstrate Catenary Zero Emissions Goods Movement System and Develop and Demonstrate Diesel Catenary Hybrid Electric Trucks	07/14/14	07/13/18	5,500,000	14,780,000
14074	City of Santa Monica	SoCalEV Infrastructure MOA to Install & Upgrade EV Charging Infrastructure	12/04/13	06/30/15	0	0
14095	City of Covina	SoCalEV Infrastructure MOA to Install & Upgrade EV Charging Infrastructure	01/22/14	06/30/15	0	0
14153	University of California, Santa Babara	SoCalEV Infrastructure MOA to Install & Upgrade EV Charging Infrastructure	02/04/14	06/30/15	0	0
14156	Galpin Motors Inc. (Galpin Ford)	Lease of Two Fusion Energi and One C-Max Energi PHEVs for a Three-Year Period	01/28/14	01/27/17	49,298	49,298
14184	Clean Fuel Connection Inc.	DC Fast Charging Network Provider	04/04/14	06/30/20	250,000	1,318,000
14199	Clean Fuel Connection Inc.	SoCalEV Infrastructure MOA to Install & Upgrade EV Charging Infrastructure	04/14/14	12/30/15	0	0

Contract	Contractor	Project Title	Start Term	End Term	SCAQMD \$	Project Total \$
Electric/Hybrid Technologies & Infrastructure (cont'd)						
14201	California State University San Bernardino	SoCalEV Infrastructure MOA to Install & Upgrade EV Charging Infrastructure	04/04/14	06/30/15	0	0
14202	Adopt-A-Charger	SoCalEV Infrastructure MOA to Install & Upgrade EV Charging Infrastructure	04/14/14	12/30/15	0	0
14204	Associated of Los Angeles	SoCalEV Infrastructure MOA to Install & Upgrade EV Charging Infrastructure	10/10/14	06/30/15	0	0
14207	City of Palmdale	SoCalEV Infrastructure MOA to Install & Upgrade EV Charging Infrastructure	07/11/14	06/30/15	0	0
14208	City of Lake Elsinore	SoCalEV Infrastructure MOA to Install & Upgrade EV Charging Infrastructure	10/15/14	06/30/15	0	0
14209	California State Polytechnic University Pomona	SoCalEV Infrastructure MOA to Install & Upgrade EV Charging Infrastructure	06/06/14	06/30/15	0	0
14210	California State University Long Beach Office of Research Programs and Sponsored Programs	SoCalEV Infrastructure MOA to Install & Upgrade EV Charging Infrastructure	07/11/14	06/30/15	0	0
14222	Odyne Systems, LLC	Develop and Demonstrate Plug-In Hybrid Electric Retrofit System for Class 6 to 78 Trucks	04/24/14	04/23/16	389,000	2,226,571
14224	Complete Coach Works	Develop and Test Retrofit All Electric Transit Bus	04/24/14	07/30/15	395,000	867,182
14236	California State University Fullerton	SoCalEV Infrastructure MOA to Install & Upgrade EV Charging Infrastructure	05/02/14	06/30/15	0	0
14256	National Strategies LLC	Develop and Demonstrate Vehicle-2-Grid Technology	09/05/14	03/04/18	250,000	3,377,689
14323	Selman Chevrolet Company	Lease Two 2014 Chevrolet Volt Extended-Range Electric Vehicles for Three Years	03/28/14	03/27/17	30,932	30,932
15021	Transportation Power Inc.	Upgrade and Demonstrate Two Electric Yard Tractors	07/14/14	12/31/15	75,000	405,000

Engine Systems

13168	National Renewable Energy Laboratory	Develop, Integrate and Demonstrate Heavy-Duty Natural Gas Engines and Vehicles	05/22/13	12/31/15	1,300,000	1,300,000
14364	Cummins Inc.	Develop, Integrate and Demonstrate Ultra-Low Emission Natural Gas Engines for On-Road Heavy-Duty Vehicles	07/14/14	08/20/16	2,061,000	5,308,000

Mobile Fuel Cell Technologies

12155	University of California Irvine	Toyota Fuel Cell Hybrid Vehicle Lease	09/27/13	12/31/15	0	0
13155	Fletcher Jones Motor Cars (Mercedes-Benz)	Lease Two F-Cell Fuel Cell Vehicles for Two Years	02/08/13	02/08/15	30,397	30,397
14139	Hyundai America Technical Center Inc.	No-Cost Lease of Fuel Cell Vehicle for Two Years	12/13/13	12/12/15	0	0

Contract	Contractor	Project Title	Start Term	End Term	SCAQMD \$	Project Total \$
----------	------------	---------------	------------	----------	-----------	------------------

Mobile Fuel Cell Technologies (cont'd)

14622	California State University Long Beach Foundation	CSULB CEERS Student Educational Project to Demonstrate Graphene Fuel Cell Catalyst	08/05/14	05/31/15	28,000	28,000
15388	Bevilacqua-Knight Inc.	Participate in California Fuel Cell Partnership for Calendar Year 2014 and Provide Support for Regional Coordinator	01/01/14	12/31/14	137,800	1,676,800

Hydrogen Technologies and Infrastructure

10046	Air Products and Chemicals Inc.	Develop & Demonstrate Renewable Hydrogen Energy and Refueling Station	12/21/09	04/30/15	750,000	8,436,735
10061	Hydrogenics Corporation	Maintenance & Data Management for the AQMD Hydrogen Refueling Station	10/30/09	12/30/13	368,000	368,000
11150	Hydrogen Frontier, Inc.	Maintenance & Operation of City of Burbank Hydrogen Fueling Station	11/24/10	01/23/16	475,000	1,635,000
10482	California State University Los Angeles	Install and Demonstrate PEM Electrolyzer, Providing Hydrogen Fueling for Vehicles and Utilizing the Technology in the Engineering Technology Curriculum at the University	03/04/11	10/03/17	250,000	1,662,000
11555	University of California Los Angeles	Construct Hydrogen Fueling Infrastructure	12/07/12	12/31/19	400,000	2,589,990
12075	Linde, LLC	Expand Hydrogen Fueling Infrastructure	11/02/12	11/02/18	250,000	2,732,177
13259	Air Products and Chemicals Inc.	Hydrogen Station Operation and Maintenance for Five Cities Hydrogen Program	03/26/13	03/31/15	390,000	390,000
13400	Energy Independence Now	Develop Hydrogen Station Investment Plan	04/05/13	01/04/15	50,000	130,000
14067	University of California Irvine	Develop Hydrogen Storage Capability for the Gas Blending Facility	12/31/13	07/16/15	200,000	688,000
15020	University of California Irvine	Develop Sampling and Testing Protocols for Analyzing Impurities in Hydrogen	08/31/14	04/12/15	114,500	114,500
15150	Air Products and Chemicals Inc.	Install and Upgrade Eight Hydrogen Fueling Stations Throughout SCAB (including SCAQMD's Diamond Bar Hydrogen Station)	10/10/14	04/09/19	1,000,000	17,335,439
15366	EPC LLC	Operate and Maintain Publicly Accessible Hydrogen Fueling Station at SCAQMD's Headquarters	10/10/14	09/14/17	0	0
15419	SunLine Transit Agency	Disposition of Dispenser from Electrolyzer Hydrogen Station Demonstration at SCAQMD's Headquarters	12/24/12	12/23/15	0	0

Contract	Contractor	Project Title	Start Term	End Term	SCAQMD \$	Project Total \$
----------	------------	---------------	------------	----------	-----------	------------------

Health Impacts Studies

12208	University of California Riverside/CE-CERT	Determine the Physical and Chemical Composition and Associated Health Effects of Tailpipe PM Emissions	01/21/12	01/31/16	175,000	1,375,000
12865	University of California Los Angeles	Develop Quantitative Cellular Assays for Use in Understanding the Chemical Basis of Air Pollutant Toxicity	06/08/12	07/31/15	368,457	368,457
14171	Southern California Research Center/Allergy & Asthma Associates of Southern California	Risk of Incident Asthma Among Children from In-Utero Exposures to Traffic Related Pollutants	09/22/14	03/21/16	99,670	317,119
14172	University of California Irvine	The Relation of Airway and Systemic Oxidative Stress to Particulate Air Pollution Exposures in an Elderly Cohort	02/17/14	08/16/15	159,974	376,368

Stationary Clean Fuels Technology

09303	Permacity Solar	Install 40kW (AC) Crystalline Silicon System at AQMD HQs	01/30/09	01/29/15	387,162	387,162
10723	Eastern Municipal Water District	Retrofit Digester Gas Engine with NO _x Tech Aftertreatment Emission Control Technology	03/16/12	06/15/15	85,000	889,000
13030	University of California Irvine	Demonstrate 300 kW Molten Fuel Cell with Exhaust-Fired Absorption Chiller	10/12/12	04/11/15	257,500	257,500
13045	ClearEdge (novated from UTC Power Corp.)	Energy Supply and Services Agreement to Install One 400 kW Phosphoric Acid Fuel Cell at SCAQMD Headquarters	09/28/12	09/27/22	450,000	4,252,680

Outreach and Technology Transfer

00069	Walsh Consulting	Technical Assistance Relating to the Use of Alternative Fuels in Mobile Sources	02/17/00	02/28/16	35,000	35,000
05128	Mid-Atlantic Research Institute LLC	Development, Outreach & Commercialization of Advanced Heavy-Duty and Off-Road Technologies	08/08/05	03/31/15	40,000	40,000
07062	The Tioga Group, Inc.	Technical Assistance Related to Air Quality Impacts of Regional Goods	12/19/06	11/30/16	58,000	58,000
08210	Sawyer Associates	Technical Assistance on Mobile Source Control Measures and Future Consultation on TAO Activities	02/22/08	02/28/16	25,000	25,000
09252	JWM Consulting Services	Technical Assistance with Review & Assessment of Advanced Technologies, Heavy-Duty Engines, and Conventional & Alternative Fuels	12/20/08	06/30/16	30,000	30,000
09337	Mark Weekly, CPA	Follow-Up Assessment of AQMD's Compliance with Special Revenue Funds	03/03/09	01/31/15	35,000	35,000

Contract	Contractor	Project Title	Start Term	End Term	SCAQMD \$	Project Total \$
Outreach and Technology Transfer (cont'd)						
11028	Martin Kay	Technical Assistance on Stationary Source Control Measures & Future Consultation on TAO Activities	08/04/10	12/31/15	40,000	40,000
11484	Gladstein, Neandross & Associates, LLC	Develop and Implement Two Customer Centers to Provide Education and Outreach to Truck Owners and Operators	01/27/11	01/31/15	150,000	150,000
12376	University of California Riverside	Technical Assistance with Alternative Fuels, Biofuels, Emissions Testing and Zero-Emission Transportation Technology	06/13/14	05/31/16	75,000	75,000
12380	The Tioga Group	Technical Assistance Related to Emissions, Advanced Technologies and Goods Movement	04/13/12	04/30/16	25,000	25,000
12381	Integra Environmental Consulting Inc.	Technical Assistance Related to Emission Inventories, Goods Movement and Off-Road Sources	04/06/12	04/30/16	110,000	110,000
12453	Tech Compass	Technical Assistance with Alternative Fuels, Fuel Cells, Emissions Analysis and Aftertreatment Technologies	06/21/12	05/30/16	75,000	75,000
12486	ICF Resources LLC	Technical Assistance with Goods Movement and Zero Emission Transportation Technologies	09/24/13	09/23/15	50,000	50,000
13194	Clean Fuel Connection Inc.	Technical Assistance with Alternative Fuels, Renewable Energy and Electric Vehicles	12/07/12	06/15/15	80,000	80,000
13198	Gladstein, Neandross & Associates, LLC	Technical Assistance with Alternative Fuels, Emissions Analysis and On-Road Sources	12/14/12	12/13/15	75,000	75,000
13408	University of California Irvine	Demonstrate Building Integration of Electric Vehicles, Photovoltaics and Stationary Fuel Cells	09/30/13	09/29/15	150,000	270,000
14185	Three Squares Inc.	Conduct Education Outreach for the Basin DC Fast Charging Network Project	04/11/15	06/30/15	49,183	49,183
15344	Clean Fuel Connection, Inc.	Technical Assistance with Alternative Fuels, Electric Vehicles, Charging and Fueling Infrastructure and Renewable Energy	09/22/14	09/22/16	60,000	60,000
15369	Breakthrough Technologies Institute, Inc.	Technical Assistance with Low- and Zero-Emission Vehicles, Fuel Cells, Stationary Applications and Emissions Analysis	11/07/14	11/06/16	30,000	30,000
15380	ICF Resources LLC	Technical Assistance with Goods Movement, Alternative Fuels and Zero-Emission Transportation Technologies	12/12/14	12/11/16	30,000	30,000
15415	Gladstein, Neandross & Associates, LLC	Technical Assistance with Alternative Fuels and Fueling Infrastructure, Emissions Analysis and On-Road Sources	11/07/14	11/06/16	60,000	60,000

Appendix C

Final Reports for 2014

Purchase & Install CNG Fueling System at Long Beach Waste Transfer Station

Contractor

Consolidated Disposal Service, LLC

Cosponsors

CDS

MSRC/AB2766 Discretionary Fund

SCAQMD

Project Officer

Larry Watkins

- 20,000 Gallon Vertical Storage Tank -12 Foot Diameter X 55 Foot High
- 10,000 scf Vaporizer
- Tanker Offload Pump Skid
- 2 Each LNG Fill Pump Skids
- 2 Each – 10 Gpm LNG Dispensers
- Universal card reader
- 28' X 28' X 3.5' High CMU Containment Wall
- LNG Control Panel
- LNG Electrical Panel (Power In Existing Building)
- Safety, Alarms Detection Systems

Background

Consolidated Disposal Service (CDS), a subsidiary of Republic Services, is a solid waste collection and transfer business that operates from a 7 acre facility located on 67th and 68th Streets near Paramount Avenue in Long Beach, CA. The company has over 220 heavy duty vehicles that are used to support many local public and private customers in southern California. The facility has an existing gasoline/diesel fueling station and a maintenance repair garage originally designed for repairing heavy-duty diesel vehicles.

The SCAQMD adopted and later amended in April 2004 Rule 1193- for Clean On-Road Residential and Commercial Refuse Collection Vehicles that required any new heavy duty vehicles purchased by CDS be alternative fuel. CDS decided to purchase new LNG vehicles and consequently, to upgrade its existing repair garage to comply with California Fire Code requirements for LNG vehicles. Therefore, a new onsite LNG station must be constructed and the repair garage must be upgraded with mechanical ventilation/gas detection for LNG vehicle repair.

Project Objective

The objective was to design, permit, install, maintain and operate a new, publicly accessible LNG fueling station at CDS's facility located at 67th Street, Long Beach, California, in order to support CDS's existing LNG fleet of 42 heavy-duty vehicles.

Technology Description

The station features include the following:

Status

The following tasks were completed:

1. Obtain City environmental and planning permits via city agencies and Boards
2. Provide calculations and conduct water pressure tests for the Fire Department
3. Identify all equipment components
4. Complete all engineering designs, drawings and specifications for the project using Weaver Electric as a sub-contractor
5. Obtain all City permits including electrical, mechanical, civil and fire permits
6. Fabricate the LNG tank, vaporizer and all other LNG specific equipment
7. Construct the LNG station and install equipment
8. Supervise the construction sub-contractor, General Physics, during the construction phase.
9. Connect the new LNG station to the existing CDS electric power supply system
10. Obtain approval from the City of Long Beach for a "Permit To Operate"
11. Fill the LNG tank and piping system with nitrogen and test for leaks
12. Fill the LNG tank, pumps and piping system with LNG and test the system for proper operation
13. Safety test all alarms, horns and shutdown systems

The station was completed on July 17, 2009. The 42 LNG refuse trucks in CDS's LNG fleet are now

fueling at the facility on a daily basis and public access is open.

Results

The new CDS LNG station has been fueling LNG vehicles since December 2009. The first month throughput was 86,000 gallons. The staff has been trained to use the new facility and CDS has negotiated competitive LNG fuel purchase contracts with local suppliers.

CDS was also responsible for the operation of the station for at least five years after commissioning, including providing annual reports and throughput data to SCAQMD through the life of this Contract.

Table 1: Actual & Projected LNG Fuel Throughput

Category	Current	2010	2014	2016 (Projected)
Number of CDS LNG Trucks	42	61	100	140
CDS Trucks*	655,200	951,600	1,560,000	2,184,000
Public Access Station**	50,000	50,000	100,000	100,000
Total Annual Throughput	705,000	1,001,600	1,660,000	2,284,000

CDS expects the emission reductions below from the LNG truck fleet:

BY END OF 2010 WITH 61 TRUCKS

(NOx) - 0.2 tons/year per truck = 12.2 T/yr

(PM10) - 0.01 tons/yr/ truck = 0.61 T/yr

BY END OF 2016 WITH 140 TRUCKS

(NOx)- = 28.0 T/yr

(PM10)- = 1.40 T/yr

There were many complex administrative, budget, permitting, design and construction obstacles during the 4 ½ year project cycle that were addressed and resolved.



Figure 1: Original Site Layout



Figure 2: New LNG Facility

Benefits

CDS trucks will no longer have to be driven over 15 miles roundtrip to a public LNG station for refueling nor repaired outside the garage. The new LNG station at CDS will provide LNG fuel for the CDS heavy-duty vehicle fleet, reducing both NOx and PM emissions. CDS can now purchase more LNG trucks with the goal of reaching a full LNG fleet by 2016.



Figure 3: Modified 12 Bay Truck Repair Garage with Gas Detection, Mechanical Ventilation and Alarms

Project Costs

The original projected costs were \$880,000. CDS incurred a cost increase of approximately \$370,000. Of this amount, \$270,000 is attributable to Chart’s construction costs from its subcontractors, additional technical consulting due to the complexities of the permitting process, and from additional work required by the City of Long Beach during extended permit negotiations. CDS also spent an additional \$100,000 on consulting and additional permit-required work. Final actual project costs totaled \$1,250,000. Co-funding was as follows: MSRC - \$297,981, SCAQMD - \$222,038, and CDS - \$729,981.

SCAQMD Contract #07051

March 2014

Purchase & Install New Public Access CNG Fueling Station

Contractor

City of Pasadena

Cosponsors

MSRC/AB2766 Discretionary Fund
SCAQMD

Project Officer

Larry Watkins

Technology Description

When the City of Pasadena began to explore the alternative fuel market, natural gas was recognized as the most popular and economical alternative fuel in this region. Utilizing natural gas powered vehicles, the City is able to significantly lower its vehicle emission levels while maintaining public service levels, lower overall fuel costs, and lower our dependence on imported oil.

Background

In 2001, the South Coast Air Quality Management District (SCAQMD) and the California Air Resources Board (CARB) began to adopt regulations that mandate public agencies to embark on effectively reducing vehicle Particulate Matter (PM) and Oxides of Nitrogen (NO_x) emissions. These regulations pertain to On-Road medium and heavy-duty trucks; refuse collection vehicles, street sweepers, and transit buses.

In 2004, the City of Pasadena began an aggressive campaign to replace its heavy duty diesel fleet with clean CNG fueled vehicles. Since that time, the City of Pasadena has replaced 10 refuse trucks, and converted eight heavy duty diesel refuse trucks to dual fuel CNG/ diesel (a total of 60% of the refuse fleet). Also, the City has replaced two street sweepers, three sewer trucks and one aerial bucket truck with CNG powered vehicles.

Project Objective

The objective of this project was to construct a CNG fueling facility to support the City of Pasadena natural gas powered vehicles and equipment, comply with all rules and regulations issued by CARB and the SCAQMD, while maintaining full services for the general public and to promote the use of alternative fuel. The limited access facility is also available on an emergency basis to the general public.

Status

On June 25, 2007, City Council authorized a contract to Gas Equipment Systems, Inc. in an amount not to exceed \$886,695 for the construction of a CNG Fueling Station. The total estimated cost for this project, including future expansion, increased from the engineers' original estimate of \$850,000 to \$1,230,520. This increase was due to rising costs of specialized equipment and services necessary for completion. To offset this overage, funds were appropriated and approved by the City Council to complete project construction. Station construction began on November 10, 2008 and passed building permit and Fire Department Compliance inspection on April 30, 2009. The station is now complete and the City has been fueling vehicles since March 12, 2009. The Final Report is being submitted at the same time of this report.



Figure 1: CNG Station Filter Dryer & Compressor at City Yard



Figure 2: City CNG Refuse Trucks at Slow-fill Filling Posts

Results/ Benefits

The City of Pasadena has replaced 16 and converted eight heavy-duty trucks. We also have three heavy-duty refuse collection trucks in line for replacement and are preparing to advertise a notice inviting bids in the upcoming months. By replacing these diesel vehicles with CNG powered vehicles, the City of Pasadena has reduced Nitrous Oxide emissions by more than 1.8 tons while diesel particulate matter is also being reduced.

CNG Use by Therms

March Therms Used	4,152
April Therms Used	8,806
May Therms Used	8,658
June Therms Used	10,130
July Therms Used	9,606
Total Therms to Date	41,352

Funding Sources

City of Pasadena	\$870,520
SCAQMD	\$165,000
MSRC	\$195,000
TOTAL	\$1,230,520

Commercialization and Applications

The City of Pasadena has been replacing its heavy-duty diesel engine fleet to vehicles powered by cleaner Compressed Natural Gas (CNG) engines. We also experienced a longer than expected construction time. We presented the contractor with the “Notice to Proceed” on September 21, 2007 with final permits signed off April 30, 2009 one year and seven months later. The initial fuel station design was based upon the 2001 California

Building Code. In January 2008, the City adopted the 2007 California Building Code. To reflect changes in the 2007 California Building Code and receive Plan Check approval, the station’s engineering design needed revisions, thus requiring additional labor and material to comply with this regulation. Additionally, data lines and conduits required an upgrade in order to transmit station data to the existing Fuel Management Database and Software System. Repairs to asphalt areas were needed due to damage caused by open trenches and normal traffic patterns at the station location. Also the installation of additional safety measures to protect the gas line necessitated additional change orders.

The City plans to operate this facility for many years while continuing to convert its heavy duty diesel fleet to CNG where available, and expand the station capacity when needed.

The City’s largest obstacle currently, is vehicle and engine manufacturers not producing an OEM product. Currently refuse chassis are available in a 50,000 – 60,000 pound Gross Vehicle Weight Rating (gvwr) chassis. Smaller 25,000 – 40,000 pound gvwr chassis are not available in an OEM CNG powered configuration such as dump trucks. Additionally, heavy duty engine manufacturers such as Detroit Diesel and John Deere have stopped producing CNG engines. The only company currently manufacturing the heavy duty CNG engine is Cummins. As the use of natural gas has become more popular and if manufacturers could produce more vehicles, state governments, municipalities, and the general public would be more likely to purchase them. This would lower emission levels and we could lower our dependence on imported oil.

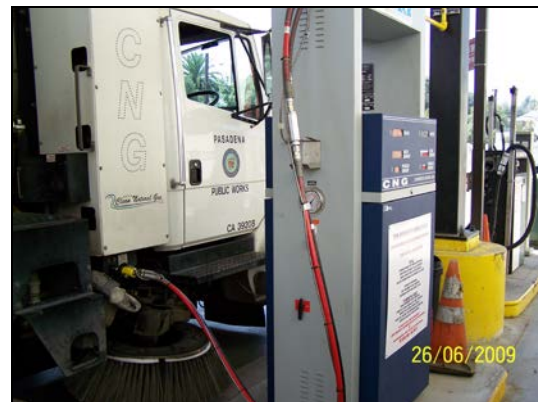

Figure 3: City CNG Street Sweeper at Fast-fill Dispenser

Upgrade Existing Public Access CNG Fueling Stations in Thousand Palms & Indio

Contractor

SunLine Transit Agency

Cosponsors

SunLine Transit Agency
SCAQMD

Project Officer

Larry Watkins

Background

Over the last four years, SunLine has had complaints with 3600 psig vehicle customers because the CNG public fueling stations could not fully fill these vehicles to about 4200 psig temperature compensated during the summer months. Currently, all new CNG vehicles are designed with the 3600 psig option and 100% of all CNG vehicles in the Coachella Valley are designed with 3600 psig.

Project Objective

The main objective was to upgrade the CNG stations and incorporate new transit 3600/3000 psig dispensers, upgrade the priority panel, install new 4500 psig storage and upgrade the public fuel island dispenser.

A facility performance specification was developed for the station that met SunLine's short- and long-term fueling requirements for a fast-fill and time-fill CNG fueling station. This included detailed plot plans, P&IDs, electrical 1 line drawing, a ROM schedule, and a 10% accuracy project estimate. SunLine and the construction contractor provided generic equipment specifications for major equipment such as the CNG compressors, CNG dispensers, CNG storage vessels/tanks, and etc. for either purchase. There were two (2) projects at the Thousand Palms facility to resolve the low pressure issues and problems and there were also two (2) projects at

the Indio facility to resolve these same issues and problems.

Technology Description

There were many changes done to both stations with this project. Upgrades to the Thousand Palms transit island consisted of a new dispenser, adding additional storage and modification to the public access dispenser program to the dispenser EPROM with no additional modification to the dispenser. The Indio station had similar changes to the transit island along with an identical new dispenser, new card reader; and the public access island was widened to accommodate larger vehicles.

Status

This project has been in operation at various stages since November 2008. With the upgrades completed, both stations are now able to provide adequate fills to the 3600 vehicles at the transit and public fuel islands. As of April 2009 the station upgrades have been completed and are in full operation.



Figure 1: Public Fuel Island

Once commissioned SunLine was required to provide the SCAQMD five years of annual reporting including throughput through 2013-14 under this Contract.

Results

After completion of the project no further complaints have been documented. Transit buses can now be filled to the required 3,600 psig. The transit buses have not been towed in and are not being exchanged for low fuel. The Thousand Palms public fuel island has been able to fast-fill medium size vehicles up to the temperature compensated amount of 4200 psig or more and no problems are expected during the summer months.

The Indio public access upgrade was accomplished with little impact to public fueling. Large vehicles are now able to get in and out of the fuel island with relative ease. The Transit Island now accepts fleet cards and is used for overflow traffic and emergencies when the public access is down for maintenance. This project-- even though it was initially delayed due to competitive bid approvals, personnel and contracts reviews and equipment delivery delays-- had immediate positive impact on the station operation and customer satisfaction.

Benefits

Efficiency in the transit and dial-a-ride service has been observed from the 3600 psig fills. Other medium-size fleet vehicles are now receiving full fills to 3600 psig which also increase their efficiency; less time refueling and less number of fill per day but an increase in volume.

With the additional buses it was anticipated the fleet would grow to 66 CNG buses with at least a 5% increase in throughput for both stations. The upgraded stations were anticipated to increase throughput by 60,000 to 70,000 GGE per year.

This contract required five years of annual reporting including throughput, which was reported as follows:

Throughput in GGEs	
2009-2010	1,244,978
2010-2011	1,262,315
2011-2012	1,417,419
2012-2013	1,548,619
2013-2014	1,664,929

This throughput met the projected throughput for this project.

Project Costs

The final cost of the project was higher than the original estimate of \$180,000 by 12%; final equipment and costs were \$200,792. The SCAQMD provided \$90,000 toward this project, with the remaining funds provided by SunLine. The card reader along with the internal cost to manage the project and support the contractors was an additional \$45,800, all of which was funded by SunLine, for overall project costs of \$246,834.

Commercialization and Applications

Overall, the improvements of the project were well received.

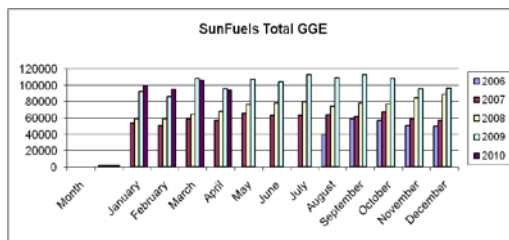

Figure 2: Throughput 2006 to April 2010

Purchase & Install New LNG Production Facility Using Landfill Gas from Altamont Landfill in Livermore

Contractors

USA Waste of California, Inc.

Cosponsors

SCAQMD

CARB

California Integrated Waste Management Board

Project Officer

Larry Watkins

Background

The project involves the construction and development of a landfill gas to liquefied natural gas (LNG) plant facility at the Altamont Landfill located near Livermore, California, which will be used to fuel WM's fleet of LNG vehicles in California and to supply other customers. A joint venture (High Mountain Fuels, LLC) between Waste Management (WM), the largest provider of solid waste collection, recycling and disposal services in North America, and Linde BOC, one of the largest industrial gas and cryogenics companies in the world.

Project Objective

The objective of the project was the design and installation of an LNG production facility at WM's Altamont Landfill in Livermore CA, through the development of an onsite purification and liquefaction facility for the recovery and conversion of renewable biomethane to LNG as a transportation grade fuel. It represents the largest demonstration of onsite purification and liquefaction of landfill gas recovery in North America and further exhibits the technical and economic viability of this renewable resource as a transportation fuel. By providing an additional LNG source for WM's LNG fleet and other California LNG fleets, the project helps expand the supply of lower carbon, renewable LNG and promotes

overall LNG consumption in the South Coast Air Basin and other areas in California.



LNG Facility at WM's Altamont Landfill

Technology Description

The process implemented at the project facility uses a multi-stage gas clean-up approach which targets the removal of chemical families of compounds rather than "key" species. The technology processes raw landfill gas by removing unwanted components such as carbon dioxide, nitrogen, hydrogen sulfide, moisture, and reactive compounds. Third party patented liquefaction technology is then used to liquefy the processed landfill gas into LNG. Additional methane recovery from the landfill co-produces all power requirements for the system (gas and refrigeration compressors, controls, transfer pumps, auxiliaries, etc.) through onsite electricity generation. The final product is stored on-site in an insulated cryogenic tank until it is trucked via 10,000 gallon capacity tanker truck to existing LNG dispensing locations within California.

Status

Construction of the plant facility was completed and in September 2009 it first began commercial operation successfully producing LNG. At that time the plant was still in start-up phase, with certain operational debugging activities ongoing.

It was anticipated the facility would operate at 60% of capacity during the first year.

Preliminary engineering for the site was completed in December 2007 and the site design and gas analysis were completed in August 2008. The majority of the equipment was delivered and installed in March and April of 2009. Commissioning of the facility began in May 2009. Feed gas was introduced in mid-July 2009 and the plant first began producing LNG in September 2009.

Once commissioned, USA Waste of California was required to provide the SCAQMD five years of annual reporting including throughput through CY 2013 as below:

Volume (gallons)	
2009	375,363
2010	1,951,448
2011	2,687,108
2012	2,739,365
2013	2,128,144

Results

At the commencement of the project, the primary goal was to construct an LNG production facility with an operational capacity to consume approximately 2,600 scfm of collected landfill gas and produce 13,000 gallons per day of LNG. The technical goals were to remove contaminants to purify the methane fraction, liquefy it by cooling to cryogenic temperatures, storing on-site, and supplying LNG to WM’s waste hauling fleet and other customers. These goals will all be met by the facility. The initial volume of LNG produced by the facility appears to yield a high quality transportation fuel, with methane content greater than 98%. The rated capacity of the plant should meet or exceed the performance specifications when running at full capacity. The facility will continually collect performance data for the systems operation.

Benefits

Use of this LNG as a transportation fuel will displace 2.8 million gallons of diesel fuel consumption and reduce CO2 emissions by 31,800 tons per year, while lowering NOx and particulate emissions and helping reduce reliance on foreign petroleum imports. WM plans to use the LNG from this facility to fuel a portion of its waste collection fleet, thereby offering a true

“closed loop” sustainability solution. Moreover, by expanding the supply of renewable LNG produced in California, this plant will help promote overall LNG consumption in the South Coast Air Basin and other areas of California, thereby helping to achieve California’s low carbon fuel standard and its desire to reduce greenhouse gas emissions.

Project Costs

The budget to construct and commission the facility was \$15.38M. Actual costs have been close to these budgeted amounts. Funding for the project was provided primarily by the High Mountain Fuels joint venture partners (WM and Linde BOC), with \$300,000 in funding being provided by the SCAQMD, and an additional \$1.15M provided by CARB and CIWMB collectively.

Commercialization and Applications

A brief examination of the population of landfills in California provided by the Landfill Methane Outreach Program indicates that there are between 17-36 landfills in the state that are sized to generate landfill gas quantities necessary to develop similar commercial-scale LNG facilities. Current estimates indicate that if all of the sites were developed, they would displace diesel fuel supply by approximately 250,000 gallons per day. Additionally, California’s total current biomethane resources (which also includes waste water treatment plants, and dairy and swine sources) are estimated at 125 bcf, which could displace over 900 million gallons of diesel fuel a year if converted to LNG and used as a transportation fuel. If only 10% of this biomethane is used for vehicle fueling, it could offset California’s need for imported diesel fuel by over 90 million gallons per year, which would avoid fossil fuel CO2 emissions of 1.9 million pounds on an annual basis.

This facility will hopefully serve as a model for similar facilities in California to utilize indigenous biogas resources and displace non-renewable fossil fuels.

Repower Four Off-Road Construction Vehicles

Contractor

TNT Blanchard (formerly TNT Grading, Inc.)

Cosponsors

SCAQMD
TNT Blanchard

Project Officer

Richard Carlson

Background

Based on the California Air Resources Board (CARB) OFFROAD 2006 emission model, there were approximately 68,600 diesel-powered off-road construction vehicles in the Basin in 2006, which together produced approximately 120 tons per day of NO_x and 7.5 tons per day of PM emissions. In order to reduce diesel emissions of NO_x and PM, the SCAQMD provided incentive funding to operators of diesel-powered off-road construction vehicles to upgrade and modernize their fleets.

On July 13, 2007, the SCAQMD Board awarded a contract to TNT Grading, Inc., to repower thirteen Tier 0 diesel-powered off-road construction vehicles with new Tier 3 diesel engines in an amount not to exceed of \$1,231,481 from the Clean Fuels Fund. This project was one of several funded as part of a required match for Carl Moyer Memorial Air Quality Standards Attainment Program (Carl Moyer Program) projects and was administered according to the 2007 Carl Moyer Program Guidelines.

Project Objective

The purpose of this contract was to reduce emissions from diesel-powered off-road construction vehicles by repowering them to meet CARB Tier 3 emission standards, the most stringent at that time.

Technology Description

A repower is the replacement of the existing engine with a new lower emission CARB certified-engine. The repower consisted of removing the existing engines and accessory components and installing new engines and associated accessory components. The repower was performed by an independent Caterpillar mechanic using Caterpillar factory engines and accessories along with specially fabricated components (brackets, wire harnesses, hoses, etc.) needed to fit the new engine into the old vehicle.

Repower is typically more cost effective in reducing emissions than replacing a vehicle, due to the higher cost of a new vehicle compared to just a new engine. The emission reduction from Tier 0 to Tier 3 is 78% for NO_x and PM and 90% for ROG (reactive organic gases). The following chart illustrates the difference in emissions between Tier 0 and Tier 3 engine emission factors.

Carl Moyer Program Emission Factors

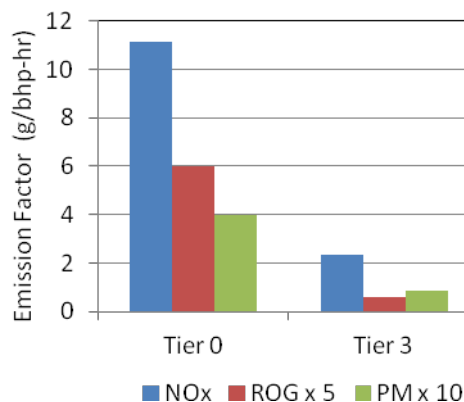

Status

Four scrapers of the type shown below were repowered in 2007 and 2008. Beginning in 2008, construction activity was substantially reduced in the Southern California region due to the severe economic recession. As a result, the contractor did not repower the remaining off-road construction vehicles. The unused contract funds

were returned to the Clean Fuels Fund for use on other projects.



Caterpillar 657B Scraper Repowered to Tier 3

Results

The repowered vehicles were inspected to confirm that the repower was completed properly, the old engines were functionally destroyed, and the repowered equipment was fully operational.

Benefits

The emission benefit of the repowers was calculated according to the Carl Moyer Program Guidelines. The Tier 3 engines in the four repowered scrapers were estimated to reduce emissions by 23 tons/year NOX+ROG and 0.81 tons/year PM compared to the original Tier 0 engines.

Project Costs

A total of \$377,801 from the Clean Fuels Fund was paid to the contractor. In addition, the contractor paid another \$124,336 for a total project cost of \$502,137. A total of \$853,680 was returned to the Clean Fuels Fund as a result of the reduced project scope.

Commercialization and Applications

Repower technologies using Tier 3 diesel engines for off-road construction vehicles are commercially available for a variety of off-road vehicles. However, the current emission standard is Tier 4, and repowers using Tier 4 engines are generally not technically feasible in older off-road vehicles. Incentive funds are now mainly used for new equipment replacement projects meeting Tier 4 standards.

Upgrade Existing Full Public Access CNG Fueling Station in Whittier

Contractor

Pupil Transportation Cooperative

Cosponsors

SCAQMD

Pupil Transportation Cooperative

Project Officer

Larry Watkins

Background

Pupil Transportation Cooperative (PTC) is a state sanctioned Joint Powers Authority serving seven area public school districts in the Whittier area. The agency serves over 4,000 students daily and operates 138 school buses, 25% of which are powered by compressed natural gas (CNG). PTC uses a time-fill system to fuel its alternative fuel buses and operates a public access CNG station first built with the help of SCAQMD funding in 1998.

PTC is committed to improving air quality and providing a safe and healthy environment for its student riders by expanding its fleet of alternative fuel school buses. PTC operates in a highly polluted region bounded by Interstate 5 on the south, State Highway 60 on the north, Interstate 605 on the west and the Orange County boundary on the east. The agency qualifies for funding based in part on the area's AB 1390-Environmental Justice designation due to its low-income status and disproportionate impact caused by air pollution in the area.

Project Objective

It was the goal of this project to upgrade the agency's CNG fueling infrastructure to support its growing fleet of clean-air school buses and offer a reliable CNG fueling station for public use.

The existing ten-year old fueling infrastructure had experienced numerous maintenance failures and operational problems dating back to May 2005. In addition to jeopardizing the efficiency of the daily school bus operation dependent on the time-fill system, the public access fueling station was routinely out of order, effectively discouraging its use by operators of CNG-powered vehicles.

The upgrade was to include installing a new compressor and relegating the existing

compressor system as backup; installing a new CNG fuel dispenser for the public access station; making safety modifications to the vehicle maintenance shop; and installing related electrical upgrades. Burnett & Burnette was enlisted for engineering, design and project management services for the project.

Technology Description

The new CNG public access fueling station upgrade includes a new ANGI two-hose dispenser for 3000 and 3600 psi fueling certified by the Los Angeles County Department of Weights & Measures; a new ANGI 75 scfm compressor as the primary with the existing twin 58 scfm compressors in stand-by; related electrical upgrades; and maintenance garage modifications that include removal of ignition sources and flame hazards and the installation of Scott mechanical ventilation fans in each of the three work bays and a Rel Tek gas detection and alarm system.

Status

PTC's consultant Burnett & Burnette issued a formal project completion notice based on a final inspection and acceptance on April 30, 2009, on schedule and slightly under budget. This contract was complete on June 2014 after five years of annual reporting was provided to the SCAQMD.

The capacity of the new compressor was changed from 100 scfm to 75 scfm to meet available site supply gas pressure and to conserve costs. No other significant problems with the procurement of equipment, installation and related construction activities were encountered. System upgrades have resolved the maintenance and operational problems that had plagued the system in past years. To help ensure continued trouble-free operation, PTC also switched station maintenance providers.



Figure 1: Public Access Fueling Station

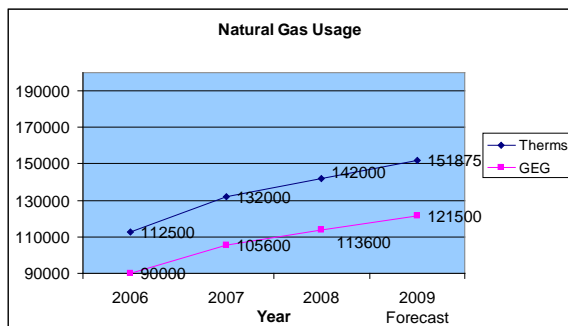

Figure 2: Time-fill Posts Refueling School Buses

Results

As depicted in the graph below, the increase in CNG usage has exceeded the projections contained in the October 2006 grant submittal by nearly 20%. The change in the station’s ownership and a renewed focus on the station’s operational readiness and reliability has resulted in increased fuel throughput at the public access station beyond projections. The addition of seven CNG school buses to the PTC fleet also contributed to increased CNG throughput overall.

The upgraded fueling infrastructure, with its primary and back-up compressors, will support increased usage of the public access station, the fueling needs of a significantly expanded fleet of CNG school buses, and will serve to reduce pollution and improve air quality overall by reducing diesel fuel consumption.



Benefits

Since the submittal of the grant application, the fleet of alternative fuel school buses at the agency has increased by 25% to a total of 35 CNG buses. There has been a reduction in CO, NOx and PM of 20% - 30% when compared to tailpipe emissions from diesel-powered buses. A new customer to the public access station operates a fleet of CNG-powered trash collection trucks which has resulted in a reduction of approximately 40% in CO, NOx and PM when compared to diesel-powered refuse trucks.

An added benefit of using CNG is fuel cost savings realized by operating CNG buses instead of buses powered by higher-priced diesel fuel.

Project Costs

Original Estimated Project Costs

Funding Source	Fueling Station	Garage	Total
Infrastructure Funds from School Bus Grant	\$42,846	0	\$42,846
Total PTC Contribution*	\$70,000	0	\$70,000
SCAQMD Contract	\$132,154	\$55,000	\$187,154
Total	\$245,000	\$55,000	\$300,000

* Note: Funds will be recovered by PTC from future Federal Excise Tax Rebate Program proceeds and projected fuel savings due to lower costs for CNG versus diesel.

The SCAQMD contract covered up to \$187,154 or 63% of project costs, whichever is less. Pupils’ funding share was estimated at \$112,846, or 37.6%.

Project Costs - Actual

Compressor/Fuel Dispenser	\$111,700
Panels/Controls	\$24,000
Electrical	\$24,300
Equipment-Garage	\$38,000
Construction-CNG	\$24,800
Construction-Garage	\$26,900
Training	\$3,000
Sub-total	\$252,700
Project Management	\$19,000

Total Project Costs \$271,700

PTC Contributions – Actual

Total PTC Contributions	100,529
-------------------------	---------

Because SCAQMD Contract #08101 could not exceed 63% of the project costs, PTC was only eligible for \$171,171. PTC’s final funding share was \$100,529 or 37%.

Commercialization and Applications

The primary applications for this project are the establishment of a reliable, on-site time-fill fueling system for the agency’s school bus fleet which currently comprises 35 CNG-powered buses and the provision of a CNG public access fueling station for public and private operators of CNG vehicles in the area. The updated fueling infrastructure will support current fueling needs and planned future expansion of the CNG school bus fleet. The updated public access station will provide reliable, 24-hour access to CNG fuel for commercial fleets and private vehicles. Fuel throughput has increased steadily for the last three years as the reliability and availability of the fueling station has improved. The public access station is situated on a busy thoroughfare and it is expected that directional signage on surrounding streets and freeways will help increase station usage. The redundant compressors on the upgraded system will support expanded public access station use and increased fuel throughput.

SCAQMD Contract #09308

November 2014

Maintain & Manage SCAQMD's Diamond Bar Headquarters' Fast-Fill CNG Refueling Station

Contractor

Trillium CNG (formerly Pinnacle)

Cosponsor

SCAQMD

Project Officer

Phil Barroca

Background

The SCAQMD has maintained a fast-fill CNG station at its Diamond Bar Headquarters (HQ) since January 2003. Since the station's opening, SCAQMD has contracted with Trillium CNG (formerly Pinnacle) to operate, maintain and manage the station. Since commissioning in 2003, average throughput has risen by 1,000 gasoline gallon equivalents (GGEs) per month each year. The current monthly throughput rate of CNG dispensed is 14,000 GGEs per month.

Given the demand and equipment age as well as evolving operating conditions, SCAQMD recognized the need to evaluate how to move forward with its station, which serves SCAQMD, visitors doing business with the SCAQMD and the general public.

In consultation with Trillium and evaluation of state-of-the-art natural gas stations, it was estimated that it would cost nearly \$900,000 to upgrade the station including replacement of compressors and dispensers. Consequently, the SCAQMD decided the optimal course would be to seek a qualified CNG fuel supplier to assume ownership of the existing CNG station by purchasing existing fueling station equipment from SCAQMD and upgrade the station with the latest state-of-the-art fueling system equipment.

Project Objective

The objective of this project was to ensure uninterrupted CNG refueling service at SCAQMD's publicly accessible CNG station in

Diamond Bar while deliberations were undertaken on how best to move forward given the aging station. This project provided additional funds to Trillium CNG to extend its contract for another six months.



Figure 1: Public Access CNG, SCAQMD Headquarters, Diamond Bar, CA

Technology Description

The SCAQMD public access station utilizes a Pinnacle Systems CNG three stage ariel compressor and a proprietary two-stage, non-lubricated hydraulic intensifier compressor that delivers 400 scfm of CNG through three (3) two-hose dispensers, each with a 3600 psi and a 3000 psi delivery. The station utilizes a single tower gas dryer to reduce moisture content. Three CNG tanks provide 30,000 scf of onsite storage. Each dispenser has a credit card reader system accepting Visa, MasterCard, and Discover cards.

Status

In late 2014, the SCAQMD Board approved the release of an RFP to solicit bids from contractors interested in assuming ownership and improving the SCAQMD CNG refueling facility. The Board also authorized execution of a consecutive contract with Trillium CNG to ensure continued operation of the station while the RFP process is undertaken. This contract, originally executed in 2009 with Pinnacle before their name change, was allowed to expire so a new interim contract could be negotiated with Trillium CNG. The CNG

station is currently operating without interruption and the RFP for a new owner/operator has closed and proposals are being evaluated.

Over the ten year life of this station there has been a steady increase in throughput, averaging 1,000 GGE/month year-to-year, with the average monthly throughput standing at nearly 14,000 GGE/month. The amount of fuel used by the SCAQMD vehicles has remained fairly consistent over the ten year operation of this facility at approximately 2,000 GGE/month. Fig 2. shows the steady increase in fuel throughput during this period, signifying a steady increase in public demand for CNG in this area.

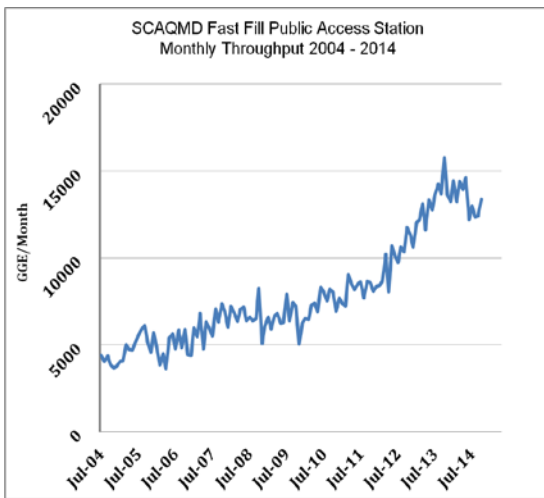

Figure 2: GGE/Month Dispensed 2004-2014

Results

Currently, there has been no disruption in the operation and service of the SCAQMD’s public access CNG station. Furthermore, within a few months a new contractor should be taking over ownership and upgrading the CNG station with state-of-the-art equipment to not only meet current needs but future growth in demand.

Benefits

The benefits associated with ensuring uninterrupted operation of SCAQMD’s public access CNG station is continued displacement of petroleum-based fuels and public support for natural gas vehicles. Figure 2 clearly demonstrates the continued and steadily increasing public demand for CNG in this region.

Project Costs

Funding for this project was \$54,000. Costs for this project are based on a \$0.60/GGE service charge by Trillium CNG; an estimated monthly throughput of 14,000 GGE/month, and up to six months of service. The current service and maintenance contract with Trillium CNG does not include electrical costs and revenue generated from this station is used to pay for the gas dispensed at this facility, the cost of the service contract, taxes and other costs directly associated with the operation and maintenance of this facility.

Commercialization and Applications

The growing demand at SCAQMD’s public access CNG station parallels on a smaller scale the growing demand for natural gas vehicles ranging from passenger class personal to commercial vehicles, e.g. taxis to heavy-duty vehicles such as school buses and refuse collection vehicles. Figures 3 and 4 provide a snapshot of the average amounts of CNG dispensed and the number of individual fueling events during a 24-hour period using a Sunday through Saturday from midnight to midnight in March 2014.

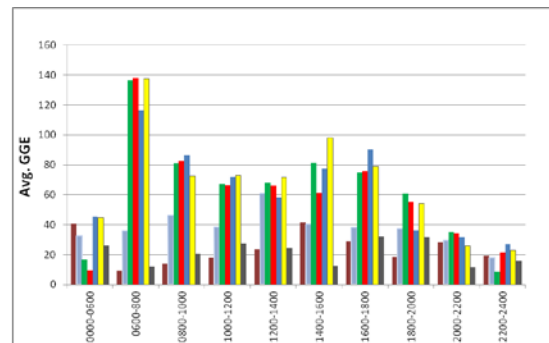

Figure 3: Avg. GGE Sun-Sat. (Mar.'14)

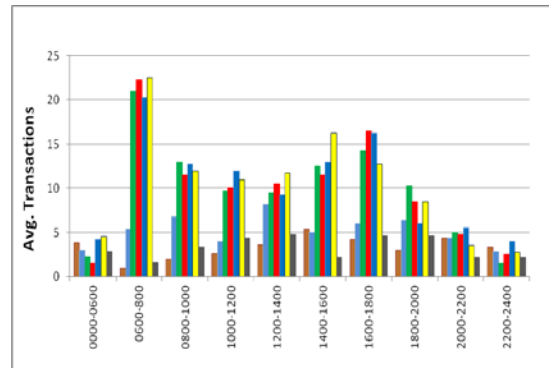

Figure 4: Avg. Fueling Episodes Sun.-Sat.(Mar.'14)

Install Two LNG Fueling Stations at the Ports

Contractor

California Cartage Company

Cosponsors

Port of Los Angeles
Port of Long Beach
SCAQMD

Project Officers

Dipankar Sarkar/Larry Watkins

Background

California Cartage Company (Cal Cartage) has facilitated the deployment of 320 LNG alternative fuel heavy duty class 8 drayage tractors for use in the Southern California Ports of Los Angeles and Long Beach. These trucks have gone into service over the last two years as part of the San Pedro Bay Clean Truck Program.

Since 50% of the Cal Cartage truck fleet operates on LNG with limited retail availability, the possibility of fuel supply disruption was of great concern, especially since at the time there was only one LNG dispensing facility in the entire port area. Consequently, Cal Cartage applied for and was awarded funding from the SCAQMD to install two 6,000 gallon LNG storage and dispenser units in separate truck yard facilities. It is notable to recognize that while Cal Cartage was undergoing its alternative fuel installations this capacity increased to four dispensing facilities in the port area.

Project Objective

The overall objective of this project was to increase the stability of the LNG supply to the overall port drayage fleet. This objective could be achieved by installing two LNG storage and dispenser units at two of Cal Cartage's truck yard facilities. The first dispenser would be installed at 6150 Paramount Blvd. in Long Beach; the second, at 1500 East Lomita in Wilmington.

Technology Description

The two LNG storage and dispensing units are built by Chart Industries. They are self-contained skid mounted tanks and dispensing systems with point of sale card readers to control inventory and record sales. In addition, these self-contained dispensers have all necessary methane and fire detection sensors. Refurbishment of these two units included new pumps, metering sensors, PLC and control cabinet, valves rebuilt and all controls rewired.



Figure 1: Completed Project Paramount Blvd.

Status

Cal Cartage contracted with Burnett & Burnett on April 27, 2010 to complete plans, drawings and permits for both Lomita and Paramount. Final permits were approved and construction started on the Paramount project on March 11, 2011. The Lomita Project was approved and started on July 7, 2011. General Physics was contracted to refurbish both QRS units on April 26, 2010. Work was completed on March 11, 2011.

Installation of the Long Beach unit was completed and signed off in February 2012; the Lomita unit was installed and signed off in early March 2012. Both systems are now up and running. The SCAQMD requires five years of annual reporting commencing one year after commissioning so this contract ends in April 2017.

Under the SCAQMD’s contract annual reporting on the station operation and throughput is required until early 2017.

Results

As a result of this project and the help from the SCAQMD and other partners, Cal Cartage has increased the use of natural gas vehicles over the last two and one-half years. The two LNG dispensers added to the local alternative fuel infrastructure are an important component to the continued successful operation and deployment of LNG trucks in the ports and surrounding operating environment. These two units bring added consistency and reliability to LNG availability in the Southern California Port area.

For the first six months of operation the two units have dispensed 912,982 gallons or 748,645 therms.

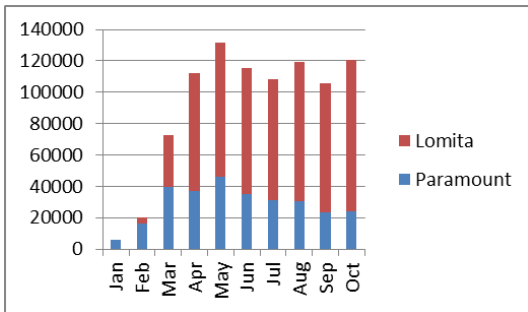

Figure 2: Volume Throughput Jan-Oct 2012

Benefits

At the time of this application there was only one LNG fueling facility available for port drayage trucks using LNG. Wait times for fuel at that location was up to two hours as LNG trucks must be fueled every day. Cal Cartage had 132 trucks and there were about 100 other LNG trucks in the port. There was real concern as to the future availability and stability of a consistent fuel supply. California Cartage Company decided to host two LNG dispensers at two of their truck yards to increase the infrastructure and availability of fuel. Since then the LNG fleet has grown to about 900 trucks total with Cal Cartage having over 300 in use today. Counting the two dispensers at these facilities there are now a total of six locations to get LNG for alternative fuel trucks.

The following chart demonstrates the increasing expansion of LNG fleets in the port area.

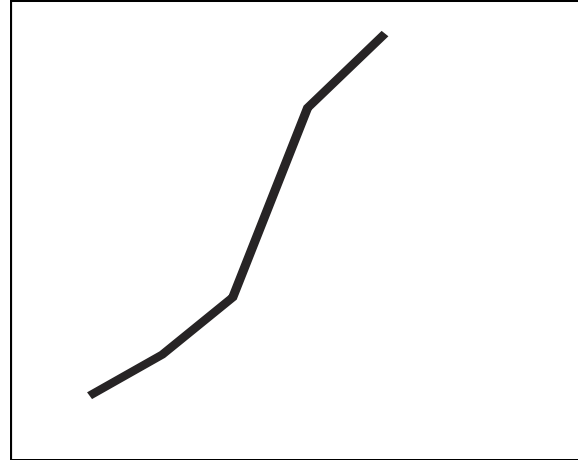

Figure 3: LNG Facilities vs Truck Service in Port Area

The additional LNG infrastructure afforded the industry the confidence to place additional LNG trucks into service at the two ports. As a result, the total LNG truck count is upwards of 900 LNG trucks. The air quality benefit of operating the LNG trucks versus diesel is as follows: 20% less GHG, 97% less carbon, and 1,000 tons per year in NO_x reduction.

Project Costs

Original project costs were estimated at \$1,193,391. Cal Cartage applied for and was granted \$1,065,000 from the SCAQMD toward this project. Actual costs of the completed project were \$1,207,601, funded as follows:

SCAQMD	\$532,500
Port of Los Angeles*	\$266,250
Port of Long Beach*	\$266,250
Cal Cartage	\$142,601
Project Total	\$1,207,601

*The Ports’ funds were pass-through via SCAQMD’s contract.

Commercialization & Applications

This project, although not new technology itself did support the growth of the LNG truck population in the port area. Additionally the project demonstrated to other potential LNG truck users that there is an opportunity to place fuel anywhere needed to support a fleet of low-emission alternative fuel trucks.

SCAQMD Contract #10055

December 2014

Install New Public Access CNG Refueling Station in Santa Ana

Contractor

Waste Management

Cosponsor

SCAQMD

Project Officer

Larry Watkins

Background

Waste Management owns and maintains a facility for waste hauling trucks located at 1800 S. Grand Avenue in Santa Ana, California. The company planned for the installation of a compressed natural gas (CNG) fueling station, and received emergency funding assistance from the SCAQMD to help defray the capital costs for installing a new fast-fill fueling island that would be made accessible to other public and private vehicles during normal business hours at that location.

Project Objective

Waste Management's objective was to install and operate a compressed natural gas fueling station at its location in Santa Ana, California.

The purpose of this project is to reduce emissions from heavy-duty refuse collection vehicles by installing the necessary infrastructure to fuel extremely low-emission natural gas vehicles. Waste Management will operate the compressed natural gas (CNG) station at its facility in Santa Ana, California.



Figure 1: Interior View of Completed Fast-Fill Fueling Island

Technology Description

This project involves construction of a CNG station with the following new equipment and components:

- Three compressors, skid mounted
- Natural gas storage vessels
- Two 2-hose fast-fill dispensers capable of providing 3,600 psig fill pressures and certified by the California Bureau of Weights and Measures
- Regenerative dryer capable of meeting SAE J1616 moisture requirements
- Development of a separate fueling island area requiring the construction of a "U" shaped access area, the fuel islands and associated lighting, canopy and security systems
- Relocate existing refuse vehicle entry, security gate and fencing to allow entrance and exit for public and private fleet vehicles.

All equipment meets API, ASME, ISA, AGA, NEC, ISA and NFPA requirements.

Status

Waste Management has completed construction of the fast-fill CNG station. The station has been operational since August 24, 2011.

Under the scope of this agreement with the SCAQMD, Waste Management constructed the CNG refueling station, including components to provide public and private fleet access with new equipment and components.

Waste Management was also responsible for the operation of the station for at least five years after installation and start of dispensing fuel, including providing annual reports and throughput data to SCAQMD through the life of this Contract. This administrative task was contracted to Gladstein, Neandross & Associates, Inc. (GNA).

Results

The station will be responsible for cost-savings due to the lower cost of natural gas as a fuel, as

well as for the reduction of emissions that are ordinarily caused by diesel.

After construction of the fast-fill CNG refueling station was completed, it was made accessible to all public and private fleets. Some examples of fleets currently using the station include: the City of Santa Ana, Orange Cab, Yellow Cab, Santa Ana Public Works, CEVA Logistics, and the Dollar Store. Waste Management shall operate the station for at least five (5) years.

Annual throughput was anticipated around 100,000 GGEs. Actual throughput for the first three years was as follows:

Throughput in GGEs	
9/1/11-8/31/12	817,471
9/1/12-8/31/13	910,389
9/1/13-8/31/14	836,575

Benefits

The successful installation of this fueling station will provide the necessary infrastructure to fuel natural gas vehicles operated by Waste Management and other public and private fleets. Natural gas is a clean, safe and abundant fuel that is domestically produced, with 99 percent used in the U.S. coming from North America.

Natural gas contains less carbon than any other fossil fuel and thus produces lower carbon dioxide (CO2) and greenhouse gas (GHG) emissions per year. In fact, natural gas vehicles produce 20-30 percent less greenhouse gas emissions than comparable diesel vehicles. Natural gas is less expensive than diesel, costing less per energy unit.

Waste Management is quite familiar with the many benefits of natural gas, and maintains the largest fleet of heavy-duty natural gas trucks in North America. The fleet is currently comprised of over 1,000 natural gas vehicles. Approximately 80 percent of these natural gas trucks operate in Southern California. Waste Management is dedicated to doing business in the most sustainable way possible, as well as offering its customers more ways to live green via the air quality benefits of CNG.

Project Costs

The total cost of the new CNG fueling station was \$1,665,514. Waste Management was awarded \$250,000 from the SCAQMD as cost-share for the fast-fill public access portion of the

CNG station project. All other costs were paid by Waste Management.

Commercialization and Applications

This project will provide the additional necessary infrastructure needed in order to make alternative fuels such as natural gas a commercially available and preferable fueling option. Commercial fleet drivers and owners of CNG-equipped vehicles can now fuel at Waste Management’s new Santa Ana station.



Figure 2: Front View of Fast-Fill Island

Additionally, public and private fleets will be encouraged to switch to natural gas as additional infrastructure is available due to both the environmental and cost-saving benefits. This project is also beneficial to those vehicles subject to Rule 1193, which requires public and private solid waste collection fleets having exclusive contracts with public entities and greater than 15 trucks to purchase or replace existing vehicles with alternative fuel vehicles when procuring vehicles.

Waste Management remains committed to reducing emissions and creating cleaner solutions, such as the construction of alternative fuel natural gas fueling stations for its fleet and others within the neighborhoods where Waste Management’s employees work and live.

SCAQMD Contract #11561

October 2014

Purchase & Deploy 34 CNG Shuttle Vans

Contractor

SuperShuttle International, Inc.

Cosponsors

SCAQMD
SuperShuttle
U.S. Dept. of Energy

Project Officer

Phil Barroca

Background

In 2009, the SCAQMD Board recognized funding from the U.S. Department of Energy (DOE) Clean Cities Petroleum Reduction Technologies for the Transportation Sector, and also provided match funds of \$750,000 from the Clean Fuels Fund for alternative fuel-powered airport ground transportation projects.

Project Objective

The project objective is to increase the use of alternative fuel and reduce petroleum dependency in the on-road transportation sector through the deployment of natural gas fueled airport ground transportation vehicles operating in the South Coast Air Basin. The project provided co-funding with SuperShuttle to purchase and deploy thirty-four (34) Ford E-350 passenger vans converted to operate exclusively on compressed natural gas (CNG) for a minimum of two years.

Technology Description

The project involves the purchase of thirty-four (34) new Ford E-350 Super-Duty XLT 12-person vans converted to operate on dedicated CNG. The base vehicle is equipped with an OEM installed gasoline-powered engine, specifically a Ford 5.4-liter V-8, Flex Fuel engine with 16 valves, electronic fuel injection, 255 rated h.p., 33 gallon gasoline fuel capacity, with a city / highway rated fuel economy of 12 and 16 miles per gallon, respectively. The vehicle is classified as medium-duty with a gross vehicle weight rating (GVWR)

of 8,000-lbs. The base, gasoline-powered vehicle is CARB-certified and emission categorized as an ULEV. Following conversion to dedicated CNG, the vehicle is CARB-certified and emission categorized as a SULEV. Each vehicle has 20 gasoline gallon equivalents (GGE) of on-board CNG fuel capacity and three Type 1 CNG tanks.

Status

All thirty-four (34) Ford E-350 Super Duty XLT vans were purchased and all 34 vehicles converted to dedicated CNG with a CARB-certified conversion system. All CNG conversion systems were manufactured by BAF Technologies and were installed at BAF in Dallas, TX. The purchase, conversion, and subsequent deployment of these vehicles occurred in two phases. The first phase included twenty (20) 2011 model year vehicles, and the second phase included the remaining fourteen (14), all 2012 model year vehicles. The first vehicle was deployed in the fourth quarter of 2011, with additional vehicles phased into service over a one-and-a-half year period. Full deployment of all 34 vehicles was achieved in the second quarter of 2013. All vehicles were used to provide ground transportation passenger shuttle service to and from Los Angeles International Airport (LAX), Long Beach Airport, Ontario International Airport, John Wayne Orange County Airport and various destinations extending as far as 140 miles from LAX. Per DOE requirements, the project requires quarterly reports on both fuel usage and mileage for each vehicle.



Ford E-350 Super Duty XLT Vans

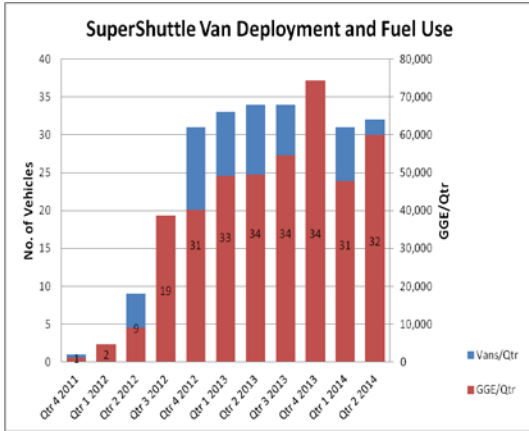

Table 1 – Van Deployment and Fuel Use

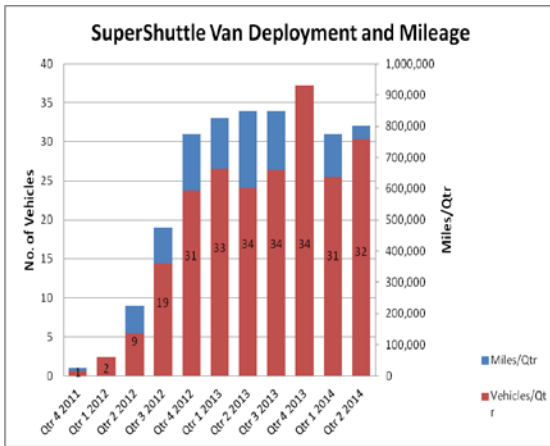

Table 2 – Van Deployment and Miles

Thirty-four vehicles were deployed over a two year period; and all 34 were in operation concurrently from the second quarter of 2013 through the fourth quarter of 2013. The last quarter of 2013 was also the highest quarter of miles accrued during this project.

Results

During the seven quarter period in which all or most of the vehicles were in continuous operation, the vehicles collectively amassed more than 4.6 million miles, and displaced more than 400,000 gallons of gasoline. Vehicle miles ranged from 66,000 to 230,000 miles over the project life; for the 34 vehicles the average vehicle miles travelled was 135,000 miles, and the average fuel consumed per vehicle over the project life was 9,750 GGE, resulting in a fuel consumption rate of 14 miles per gallon.

The 2012 Ford E-350 Super-Duty XLT van is classified as a medium-duty vehicle with a GVWR of 8,000-lbs. Based on CARB Executive Orders and the certified emissions for both the Ford OEM gasoline-powered version of this vehicle and the BAF CNG-powered version of this vehicle, the CNG-powered vehicle emits 47% less emissions in terms of hydrocarbon + NOx emissions. All 34 vehicles produced over 700 lbs per year less emissions than their gasoline counterparts.

Benefits

Relative to its gasoline-powered counterpart, the CNG version of this vehicle is 47% cleaner in hydrocarbon + NOx emissions. The vehicles are also helping to displace the use of petroleum based fuels. The full benefits of this program are yet to be determined as these vehicles are expected to produce increased benefits over their full life. Based on full-life projections of 200,000 to 300,000 miles per vehicle, these 34 vehicles collectively will displace the use of 480,000 to 720,000 gallons of gasoline over this projected lifetime/usage.

Project Costs

The total amount spent on vehicle purchase and conversion to dedicated CNG is calculated at \$1,431,894. The total funding award to this project was \$464,900 comprising \$123,000 from the DOE and \$341,900 from the SCAQMD. A Final Report on this project has been completed and is on file.

Commercialization and Applications

The technology utilized in this project has been successfully demonstrated. The expected outcome of this project is to increase awareness and viability of using alternative fuel vehicles and to promote the use of non-petroleum based fuel sources, and the concurrent displacement of petroleum based fuels.

Demonstrate Natural Gas-Powered Police Pursuit Vehicle

Contractor

A-1 Alternative Fuel Systems

Cosponsor

SCAQMD

Project Officer

Phil Barroca

Background

In November 2011, the SCAQMD Board approved \$65,000 from the Clean Fuels Fund to lease and demonstrate with local police jurisdictions a new 2011 dedicated compressed natural gas (CNG)-powered Ford Crown Victoria (FCV) Police Pursuit Vehicle (PPV). The Contractor on this project was A-1 Alternative Fuel Systems (A-1), based in Fresno, CA. A-1 performed the conversion of the vehicle to CNG, coordinated with Wondries (Alhambra, CA) on a two year lease and maintenance of the vehicle, and with 10-8 Retrofit (Ontario, CA) on the various vehicle up-fittings. At the outset of the program, fifteen (15) cities and police jurisdictions expressed an interest in demonstrating this vehicle.

Project Objective

The project objective was to provide local law enforcement agencies the opportunity to demonstrate a fully equipped police pursuit vehicle that is powered by dedicated CNG to both reduce emissions and to potentially reduce department operating costs. The demonstration vehicle was built on the same platform as the ubiquitous gasoline FCV used by law enforcement agencies for many years and prepared for regular deployment and routine police service. The police departments and officers demonstrating this vehicle were asked to subject the CNG vehicle to the same rigors as their regular PPV and to evaluate and assess the CNG vehicle's performance. Officers were provided with a prepared survey to score various parameters, and to provide comments. The survey was considered

critical to better assess the vehicle needs of police departments and their officers.

Status

The contract to demonstrate the CNG PPV was executed in April 2012. The FCV PPV was secured from Wondries Ford and the vehicle was converted to dedicated CNG by A-1 in June 2012. The vehicle was transferred to 10-8 Retrofit for up-fitting of the hard rear seat, light bar and siren, push bumper, prisoner screen, shotgun rack, and multijurisdictional radio. All up-fits were completed by October 2012. The first city to demonstrate the vehicle was Monterey Park, followed by Sierra Madre, Pomona, San Fernando, and Orange. The vehicle was also showcased at the Alt Fuel Expo in Santa Monica in September 2013. The demonstration program concluded in December 2014; the vehicle was returned to Wondries Ford with approximately 6,000 miles, for potential sale.

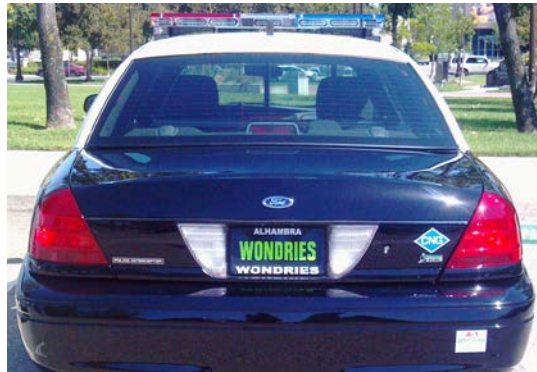

Figure 1: 2011 CNG FCV Police Pursuit Vehicle

The demonstration vehicle was a new 2011 gasoline-powered Ford Crown Victoria (FCV) that was converted to dedicated CNG-power using an EPA-certified Evotek (Impco Technologies) CNG conversion system with a CARB equivalent emission ranking of LEV2 SULEV. The 2011 FCV is equipped with a 4.6L V8 flex fuel engine with 250 h.p. and 297 lb-ft. torque. The gasoline vehicle is equipped with a 19 gallon fuel tank; an estimated city/highway fuel economy of 14/21 mpg, and is CARB certified LEV 2 ULEV. The CNG-powered vehicle's gasoline tank was

removed and initially replaced with two 3.4 GGE tanks in the trunk, and two 2.7 GGE tanks under body. An additional 2.7 GGE tank was added in the trunk to provide extra use and range bringing the total CNG fuel capacity to 14.9 GGE. The net added weight to the vehicle, primarily from the CNG tanks, was 450-lbs. The added weight and positioning of the fuel tanks in the trunk area prompted comments about “bottoming-out” of the rear of the vehicle and the subsequent installation of heavy-duty rear springs. Fuel economy estimates for the CNG version averaged 16 mpGGE.

Results

The dedicated CNG-powered police pursuit vehicle was successfully demonstrated to five police departments and at least nineteen police officers within the jurisdictional boundaries of the SCAQMD over a two-year and two-month period. The vehicle accumulated approximately 6,000 miles. Survey scoring ranged from 1 (poor) to 5 (excellent) for overall satisfaction, drivability and performance, fuel economy, and recommending the vehicle. The vehicle scored an overall 2.6 and a 2.95 for drivability and performance. Comments included lack of trunk space, frequency of refueling, lack of power relative to the gasoline version, stalling and rear suspension issues.

The City of Monterey Park cited the need for more fuel capacity, and that the rear of the vehicle was “bottoming-out” on driveways. In response to fueling needs, an additional 2.7 GGE CNG tank was installed by A-1 (not Clean Fuels funded). Following similar rear suspension comments from the City of Sierra Madre, the vehicle was retrofitted with heavy-duty rear coil springs by Wondries. The vehicle was subsequently tested again by the sergeant at Monterey Park along with the project officer. The sergeant subjected the vehicle to: acceleration tests, braking tests, high speed right-angle and slalom turns, various grade transitions both up-hill and down-hill and at various speeds, and transmission changes from drive to stop to reverse, to test for engine stalling.

The acceleration test occurred on a stretch of public road and the vehicle achieved 95 mph. The officer noted that the vehicle still lacked acceleration above 70 mph compared to the gasoline FCV and attributed that to less “high-end” torque than the gasoline-powered model. The sergeant noted that the vehicle’s braking from high speed was good and that the vehicle’s handling had improved

significantly from the prior demonstration and performed notably well in executing all turns.

The vehicle was subjected to various grade transitions at various speeds, including a slow speed grade transition on an upward exit ramp from an underground parking garage (the officer recalled this same grade transition caused the vehicle to bottom-out during the preliminary demonstration). The vehicle was also driven at higher speeds (25-30 mph) through grade transitions from flat (0% grade) to an immediate upward pitch of 10% -15% grade. The Sgt. was unable to cause the vehicle to “bottom-out” at any time during the test drive. The vehicle was subjected to various grade transitions at extreme speeds, but presumably indicative of what is required of police pursuit vehicles operating under real-world conditions. The officer also subjected the vehicle to numerous “reverse-tests” to see if the vehicle stalled when the transmission was changed from drive to reverse (after bringing the vehicle to a complete stop). At no time during the “reverse-tests” did the engine stall.

Benefits

Relative to its gasoline-powered counterpart, the CNG version of this vehicle is more than four times cleaner in hydrocarbon + NOx emissions and use of CNG helps to displace the use of petroleum based fuels. Costs of CNG relative to gasoline are available. The full benefits of this program are yet to be determined.

Project Costs

Funding for this project was \$65,000; actual costs will slightly under this amount. Costs included a two-year vehicle lease, the conversion from gasoline to dedicated CNG, the up-fits from a base model to a fully deployable police vehicle, e.g. lights and sirens, push bar, radio, etc., vehicle maintenance, vehicle refueling (if unavailable), and vehicle demonstration.

Commercialization and Applications

The technology utilized in this project has been successfully demonstrated. The expected outcome of this project is to increase awareness and viability of using alternative fuel vehicles and to promote the use of non-petroleum based fuel sources.

Optimize & Demonstrate Selective Catalytic Regenerating Technology (SCRT) for NO_x & PM Emissions Control

Contractor
Johnson Matthey, Inc.

Cosponsors
U.S. EPA
SCAQMD

Project Officer
Jeff Cox

Background

There is a great deal of test data and field experience that demonstrate the performance and reliability of passive technologies for the reduction of PM. There has been little data collected that demonstrates the performance and impact on fleet operations of the newer retrofit NO_x reduction technologies using SCR. A demonstration of the emission reduction and the impact on fleet operations of these new technologies is necessary to evaluate the potential impact of the retrofit technology.

Project Objective

This project was undertaken to demonstrate the emission reduction possible with a retrofit 4-way emission control technology on sixty-nine (69) heavy-duty diesel trucks operating in the South Coast Air Basin. Since SCR based NO_x reduction is affected by the exhaust temperature profile of the application, special attention was paid to the relationship between system performance and exhaust temperature. Of secondary concern is the impact that such a technology will have on a fleet from an operation and maintenance standpoint.

Technology Description

Johnson Matthey (JM) has developed a product that combines their Continuously Regenerating Technology (CRT®) with Urea based Selective Catalytic Reduction (SCR) to be retrofit on Heavy Duty Diesel vehicles. The SCRT consists of several subsystems; CRT, SCR Catalyst module and urea dosing system. The CRT was previously verified by CARB as a level 3 PM control device (>85% reduction) that also meets the 20% NO₂ requirement for 1998-2002 MY heavy duty diesel engines. The SCRT system uses NH₃, carried on

the vehicle as urea, to reduce NO_x over a vanadium based SCR catalyst. The precise air assisted injection of urea is performed using an OE dosing pump controlled by an ECU developed by JM.

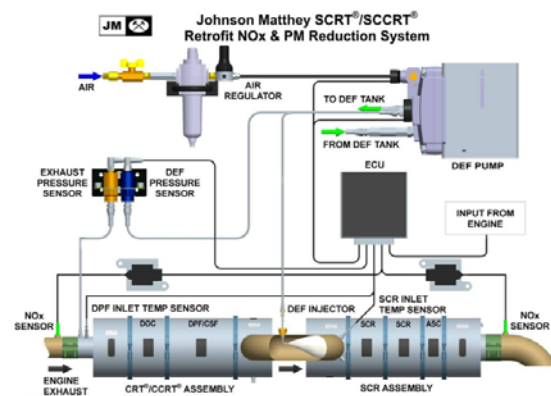

Figure 1: System Schematic

Status

The phases of this project were:

- 38 systems were installed and operated on trucks within five fleets. The trucks were equipped with Detroit Diesel Series 60, Cummins ISM, Mercedes-Benz OM460LA, and Navistar DT466E/HT engines built between 1998 and 2002.



Figure 2: SCRT Typical System Installation

- Data monitoring on select trucks.
- Chassis Dyno Emissions Testing that was originally part of the program was not performed.
- CARB Verification
A CARB test plan was completed and

submitted on September 15, 2010 in reference to a passive diesel particulate filter plus urea-based SCR. There was an SCR catalyst formulation change that occurred during the program. All program field installations were vanadium SCR.

Results

Emissions data was gathered using NOx sensors to compare system out and engine out NOx levels during actual operation. The daily operational NOx reduction was as high as 78% as seen below.

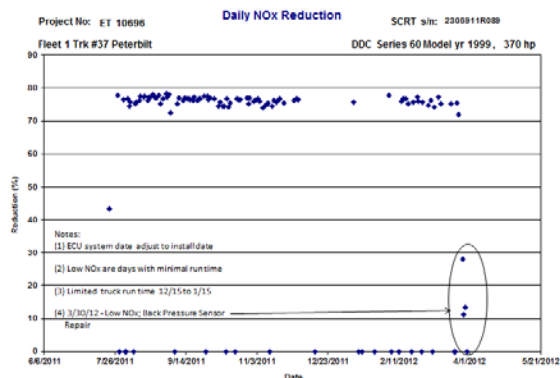

Figure 3: Daily NOx Reduction Graph - 569 Hours of Operation

Other information generated by the project included:

- Verification that 70% NOx reduction can be achieved with a CRT inlet temperature over 240°C for 40% of the operating time.
- Some earlier model year engines did not meet requirements for J1939 CAN Network availability.
- Wire splices in the electrical harness had failure issues during installation where harness routing had aggressive bend radius during installation.
- A universal Class 8 system bracket design was integrated on all of the participating vehicles.

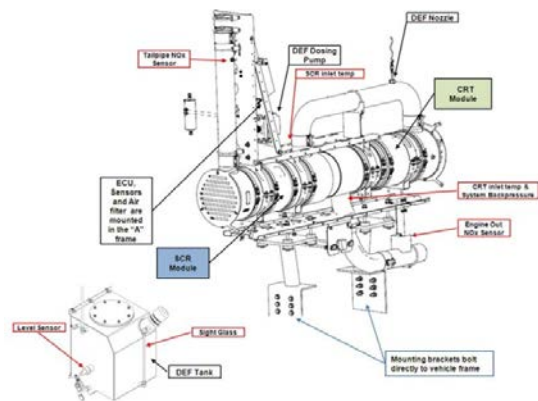

Figure 4: Vehicle Integration Application Schematic

- DEF connections (flareless tube, pipe and JIC fittings) from tank to pump proved to be a challenge at initial system commissioning requiring some post installation service downtime.
- Calibration of DEF level sensor at installation was not always accomplished requiring some post installation service downtime.
- The installation location and orientation of the tailpipe NOx sensor was demonstrated as un-reliable in some installations.

Benefits

Besides the percentage of NOx reduction shown, the data gathered during this program was able to show that some applications could remove as much as 4.1 lbs. of NOx per daily average.

Project Costs

The contract executed for this program was in the amount of \$2,300,000. The U.S. EPA provided funding in the amount of \$2,000,000 and SCAQMD provided \$300,000. The program was subsequently reduced in scope from 69 to 38 retrofits and chassis dynamometer testing was not performed. Consequently, final program costs totaled \$1,561,181; thereby, de-obligating \$738,819 from the contract.

Commercialization and Applications

This demonstration program identified areas in the system that needed improvement like the wiring harness, DEF line connection methods, and tailpipe NOx sensor orientation to increase the system reliability. The universal class 8 bracket design system behind the vehicle cab integrated well with various over-the-road bulk delivery applications. The universal bracket design allowed for the system to be assembled with common parts with better volume purchasing potential.

Optimize & Demonstrate Selective Catalytic Continuously Regenerating Technology (SCCRT) for NO_x & PM Emissions Control

Contractor

Johnson Matthey, Inc.

Cosponsors

U.S. EPA
SCAQMD

Project Officer

Jeff Cox

Background

There is a great deal of test data and field experience that demonstrate the performance and reliability of passive technologies for the reduction of PM. There has been little data collected that demonstrates the performance and impact on fleet operations of the newer retrofit NO_x reduction technologies using SCR. A demonstration of the emission reduction and the impact on fleet operations of these new technologies is necessary to evaluate the potential impact of the retrofit technology.

Project Objective

This project was undertaken to demonstrate the emission reduction possible with a retrofit 4-way emission control technology on sixty-nine (69) heavy-duty diesel trucks operating in the South Coast Air Basin. Since SCR based NO_x reduction is affected by the exhaust temperature profile of the application, special attention was paid to the relationship between system performance and exhaust temperature. Of secondary concern is the impact that such a technology will have on a fleet from an operation and maintenance standpoint.

Technology Description

Johnson Matthey (JM) has developed a product that combines their Catalyzed Continuously Regenerating Technology (CCRT®) filter with Urea based Selective Catalytic Reduction (SCR) to be retrofit on Heavy Duty Diesel vehicles. The SCCRT consists of several subsystems; DOC, CSF, SCR Catalyst module and urea dosing system. The CCRT filter technology was previously verified by CARB as a level 3 PM control device (>85% reduction) for 1994-2006

MY heavy duty diesel engines. The SCR system uses NH₃, carried on the vehicle as urea, to reduce NO_x over a non-vanadium based SCR catalyst. The precise air assisted injection of urea is performed using an OE dosing pump controlled by an ECU developed by JM.

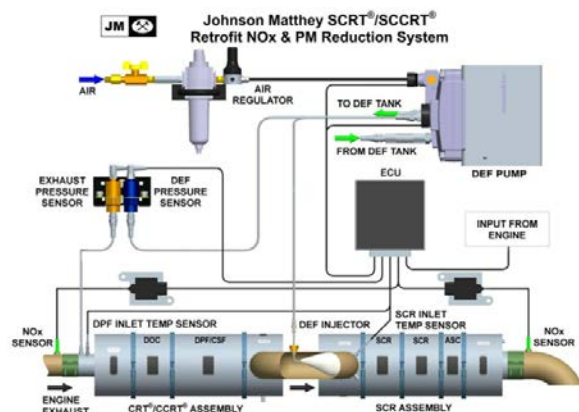

Figure 1: System Schematic

Status

The phases of this project were:

- 69 systems were installed and operated on trucks within two (2) fleets. The trucks were equipped with Cummins ISX and Mercedes-Benz MBE4000 engines built between 2005 and 2006.



Figure 2: SCCRT Typical System Installation

- Data monitoring on select trucks.

- Chassis Dyno Emissions Testing that was originally part of the program was not performed.
- CARB Verification
A CARB test plan was completed and submitted during the program on November 15, 2011 in reference to a passive diesel particulate filter plus urea-based SCR.

Results

Emissions data was gathered using NO_x sensors to compare system out and engine out NO_x levels during actual operation. The daily operational NO_x reduction was as high as 90% as seen below.

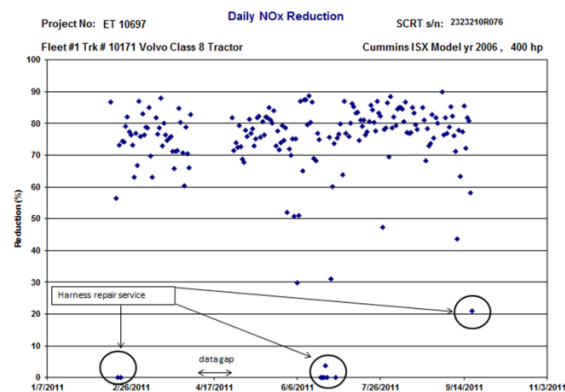

Figure 3: Daily NO_x Reduction Graph – 1,260 Hours of Operation

Other information generated by the project included:

- Verification that 70% NO_x reduction can be achieved with a CRT inlet temperature over 240°C for 40% of the operating time.
- Wire splices in the electrical harness had failure issues during installation where harness routing had aggressive bend radius during installation.
- A universal Class 8 system bracket design was integrated on all of the participating vehicles.

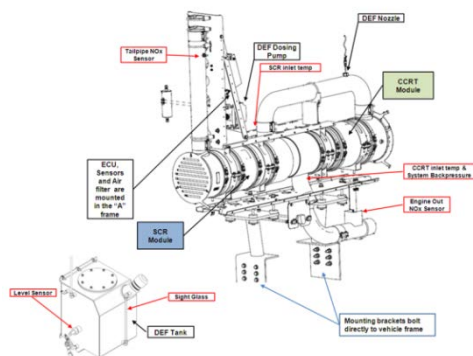

Figure 4: Vehicle Integration Application Schematic

- Operation on a long haul route on California Interstate I-15 targeting Baker Grade, Cajon Pass, and Mountain Pass experienced system backpressure warnings and alarms. These routes demanded sustained maximum engine loads during hauls up sustained grades, with ambient temperatures exceeding 110°F during the peak summer season, and high elevations.
- DEF connections (flareless tube, pipe and JIC fittings) from tank to pump proved to be a challenge at initial system commissioning requiring some post installation service downtime.
- Calibration of DEF level sensor at installation was not always accomplished requiring some post installation service downtime.
- The installation location and orientation of the tailpipe NO_x sensor was demonstrated as un-reliable in some installations.
- Bracket system durability failures were observed on some trucks on one fleet.

Benefits

Besides the percentage of NO_x reduction shown, the data gathered during this program was able to show that some applications could remove as much as 8 lbs. of NO_x per daily averages.

Project Costs

The contract executed for this program was in the amount of \$2,300,000. The U.S. EPA provided funding in the amount of \$2,000,000 and SCAQMD provided \$300,000. Because the chassis dynamometer testing was not performed, the total program costs were \$2,223,500; thereby, de-obligating \$76,500 from the contract.

Commercialization and Applications

This demonstration program identified areas in the system that needed improvement like the wiring harness, DEF line connection methods, and tailpipe NO_x sensor orientation to increase the system reliability. The universal class 8 bracket design system behind the vehicle cab integrated well with various over-the-road applications for bulk goods delivery. Certain vehicle applications challenged the bracket system where improvements are required before commercialization. The universal bracket design allowed for the system to be assembled with common parts and the price of the system to be lowered because of better volume purchasing.

SCAQMD Contracts #12113, et al.

March 2014

Retrofit 200 Heavy-Duty Diesel Trucks with DPFs

Contractors

Southern Counties Terminals dba Griley Air Freight
South Bound Express, Inc.
National Ready Mixed Concrete, Co.
Standard Concrete Products, Inc.
Challenge Dairy Products, Inc.
Bear Trucking, Inc.
RRM Properties, Inc.
Gaio Trucking, Inc.
Spragues Ready Mix
Pipeline Carriers, Inc.

Cosponsor

SCAQMD

Project Officer

Mei Wang

DPFs are diesel emission control strategy (DECS) that traps particulate matter and other pollutants from diesel exhaust before entering the atmosphere. The captured materials are then combusted using the diesel engine's exhaust temperature or an external source of heat such as a diesel burner or electric heater.

Status

The retrofit devices were successfully installed on all the trucks under this project before December 2011. The retrofitted trucks have been operating without issues.



DPF on an RRM Properties Truck

Background

Diesel pollution from current goods movement operations greatly impacts the health of community resident near ports, rail yards, distribution centers, and roads with high truck traffic. In the Los Angeles/Inland Empire region, which includes California's largest concentration of goods movement facilities, the result has been major health risks associated with very high regional levels of ozone and particulate pollution. This project provides grants to heavy-duty diesel truck owners/operators on a competitive basis to upgrade their equipment to cleaner technologies.

Results

This project provided direct PM emission reductions as listed in the table on the next page. Table 1 also provides individual contract numbers.

Project Objective

The objective of this project was to provide funding to heavy-duty diesel truck owners/operators to retrofit their trucks with diesel particulate filters (DPFs) and reduce their particulate matter (PM) emissions in a cost-effective and expeditious manner.

Technology Description

Retrofit technology modifies the diesel exhaust system by replacing the existing muffler with an emission control diesel retrofit device that removes (PM) and other pollutants from the diesel exhaust stream and traps them inside the device.

Table 1: PM Emission Reductions by Contract

Contractor	PM Emission Reduction (lb)/Project Life (2 Years)
Southern Counties Terminals dba Griley Air Freight Contract #12113	134.5
South Bound Express, Inc. Contract #12114	181.8
National Ready Mixed Concrete, Co. Contract #12118	913.8
Standard Concrete Products, Inc. Contract #12120	2563.2
Challenge Dairy Products, Inc. Contract #12121	62.5
Bear Trucking, Inc. Contract #12122	179.8
RRM Properties Ltd. Contracts #12123 & #12175	16535.6
Gaio Trucking, Inc. Contract #12124	2346.1
Spragues Ready Mix Contract #12125	103.4
Pipeline Carriers Inc. Contract #12186	1841.4

Benefits

The implementation of the project provides direct and cost-effective PM emission reductions. The retrofitted trucks are likely to operate many more years in the South Coast Air Basin even after the contract ends.

Project Costs

The SCAQMD’s total contribution from the Clean Fuels Fund was \$1,035,000. Project participants contributed the remaining costs. Project costs are broken down as follows.

Table 2: Total Project Costs by Contractor

Contractor	No. of Trucks	Total Cost of Devices	Total Cost of Installation	Total Project Cost
Southern Counties Terminals dba Griley Air Freight	9	\$30,392	\$6,585	\$39,750
South Bound Express, Inc.	3	\$33,018	\$4,274	\$37,292
National Ready Mixed Concrete, Co.	13	\$154,960	\$39,975	\$168,285
Standard Concrete Products, Inc.	15	\$176,930	\$25,450	\$218,235
Challenge Dairy Products, Inc.	3	\$26,475	\$6,000	\$34,394
Bear Trucking, Inc.	1	\$11,255	\$3,041	\$14,296
RRM Properties Ltd.	134	\$991,248	\$327,000	\$1,695,551
Gaio Trucking, Inc.	8	\$69,156	\$12,299	\$81,455
Spragues Ready Mix	4	\$26,407	\$6,703	\$30,704
Pipeline Carriers Incorporated	10	\$122,500	\$18,000	\$149,994
Total	200	\$1,642,341	\$449,327	\$2,469,956

Commercialization and Applications

The DPFs used for this project are fully commercialized CARB-verified Level 3 Plus devices that reduce PM by at least 85%. The DPFs are installed on many on-road heavy-duty diesel trucks to reduce PM emissions.

Demonstrate DPF Technology on Two School Buses

Contractor

Chaffey Joint Union High School District

Cosponsors

SCAQMD

Project Officer

Richard Carlson

Background

Chaffey Joint Union High School District (Chaffey) operates a large fleet of school buses. Sixteen buses equipped with diesel engines using hydraulic electronic unit injectors (HEUI) had previously been retrofitted with Cleaire Horizon diesel particulate filters (DPFs) under the Lower Emission School Bus Program. However, immediately following the installation of the Horizon DPFs, the buses began to experience higher rates of injector failures, oil leaks, turbo failures, power loss, and other engine-related problems on these buses than previously experienced. These engine problems were attributed to high backpressure caused by plugged Horizon DPFs.

Chaffey presented their concerns about the apparent problems created by the Horizon DPFs to the SCAQMD and California Air Resources Board (CARB). As a result, a cooperative study was undertaken to review Chaffey’s bus utilization and duty cycles, engine conditions, and maintenance practices. As a result of this, it was agreed that Chaffey could evaluate alternate DPF technologies to determine if the performance and maintenance problems were due to the Horizon design.

On March 1, 2013, the SCAQMD Board awarded a contract to Chaffey to purchase, demonstrate, and evaluate two retrofit DPF technologies in the amount of \$30,000.

Project Objective

The objective of this project was to evaluate two alternate DPF technologies to the Horizon and

determine if one was better suited to the Chaffey buses and would provide better bus operation and less maintenance expense.

Technology Description

The Horizon technology consisted of a manually operated, externally powered electric heater coil in front of a DPF substrate. When the bus was in operation, the DPF collected exhaust particulate. When the bus was parked, and when indicated by a warning lamp that regeneration was required, the operator/mechanic plugged in the heater system. The heater operated for a fixed time to raise the temperature of the DPF enough to burn off the collected soot.

Two alternate technologies were chosen for this demonstration: 1) the ESW *Thermacat* actively regenerated DPF and 2) the Donaldson *LNF* passively regenerated DPF. The ESW DPF uses diesel fuel injected in front of a catalyzed wall-flow DPF while the bus is in normal operation. The fuel injection start, rate, and duration is automatically controlled by the Thermacat control module without operator involvement whenever the exhaust backpressure builds up to a set value. The LNF continuously regenerates by reacting NO₂ in the exhaust gas with the collected particulate. The LNF consists of a flow-through catalyzed DPF followed by a conventional non-catalyzed wall flow DPF. The catalyzed section reacts NO in the exhaust to NO₂. The system provides high collection efficiency along with continuous regeneration at low exhaust temperatures.

These two technologies were selected because they were the only ones approved by the California Highway Patrol for use on the school buses operated by Chaffey. The Thermacat was more expensive than the LNF but was expected to provide more consistent and reliable operation compared to the Horizon and LNF due to the automatic regeneration feature during normal driving. The LNF was attractive due to its simplicity and lower cost, provided its performance was acceptable. The two DPFs are shown in the photographs below.



Figure 1: ESW Thermacat installed on Bus 62



Figure 2: Donaldson LNF installed on Bus 55

Status

Two buses previously equipped with Horizon DPFs which had experienced repeated incidents of severe power loss were selected for the demonstrations. Both had new engines installed in 2011. The Horizon DPFs were removed and the engines checked. Both engines were found to be in good condition without excessive oil or fuel consumption leaks and fuel injectors operating within specification. Exhaust temperatures were recorded using data loggers.

The buses were both 60 passenger Type D school buses with 7.2-liter Caterpillar 3126 engines. The engine uses hydraulically actuated electronic unit injectors (HEUIs). Bus 62 has the ESW Thermacat DPF. Bus 55 has the Donaldson LNF DPF.

As of December 18, 2013, both buses had operated for approximately three months and accumulated 8,616 miles on the Thermacat and 6,538 miles on the LNF. Regular maintenance was performed on the buses and monthly

inspections of the engines and checks of fuel for contamination with oil or water were performed. No oil was added to either engine during this period. The buses remained in operation continuing the demonstration through the end of the school year.

Results

Both buses operated satisfactorily without any performance losses or engine mechanical issues (turbocharger or injector failures). With the Horizon DPF, problems would have already occurred on these buses during these time and mileage periods.

Chaffey recommends that all Horizon units be replaced with Thermacat DPFs and is requesting additional funding for their replacement from SCAQMD.

Benefits

The study demonstrated that both alternate DPF technologies operated satisfactorily without the performance, operational, and maintenance issues experienced with the Horizon DPF. The study demonstrated that not all DPFs are appropriate for any particular engine design or and vehicle duty cycle.

Project Costs

DPF Costs	
ESW Thermacat	- \$20,300
Donaldson LNF	- <u>\$17,822</u>
Total Cost	- \$38,122

Funding Source	
SCAQMD	- \$30,000
Chaffey JUHSD	- \$ 8,122

Commercialization and Applications

Both ESW Thermacat and Donaldson LNF DPF technologies are currently in production, verified, and commercially available. .

SCAQMD Contract #11614

September 2014

Demonstrate Battery-Electric Heavy-Duty Trucks

Contractors

Transportation Power, Inc. (“TransPower”)
EPC Power Corp.

Cosponsors

CEC
SCAQMD
U.S. EPA

Project Officer

Joseph Impullitti

Background

In August 2010, SCAQMD applied for a \$400,000 award from U.S. EPA Region 9’s Clean Air Technology Initiative (CATI) Program. SCAQMD was awarded \$300,000 to demonstrate battery electric heavy-duty trucks traveling from the Ports to intermodal facilities, enabling the SCAQMD to fund an unsolicited proposal that had been submitted by TransPower, which offered to leverage California Energy Commission funds and create an expanded electric truck demonstration program involving two vehicles.

Project Objective

TransPower was tasked to develop and demonstrate two heavy-duty battery electric Class 8 trucks as well as develop the manufacturing capability for the electric drive system in California. The project had two overarching objectives: to demonstrate a superior electric drive technology for heavy-duty trucks and to use this demonstration project as a springboard for rapid commercialization of a modular electric drive system.

Technology Description

A zero-emission battery-electric drive system was to be installed by TransPower into two Class 8 truck tractors. Each drive system was intended to utilize a network control architecture to control modular components, including high-power drive motors and inverters along with electrically-driven

accessories, powered by lithium battery packs. A key technology advancement enabled by this project was development of a new onboard inverter-charger unit (ICU), which combines the functions of a motor inverter and battery charger. Other key advances included application of a new automated manual transmission and advanced battery management technologies to Class 8 electric trucks.

Status

The ElecTruck period of performance began on July 8, 2011, and was originally scheduled to end after 28 months (November 8, 2013), but was extended to September 30, 2014, to allow more time for manufacturing and testing the second truck built under the project, the “Pilot Truck.” The Pilot Truck (shown here) was successfully operated under real-world conditions for nearly a full year and is now being upgraded to utilize more advanced components whose designs were enabled by the many lessons learned during the ElecTruck project. By the end of 2015, at least 20 medium- and heavy-duty electric vehicles will be in operation in California demonstration projects, using technologies and components developed or first demonstrated in Class 8 trucks during the ElecTruck project.



Figure 1: Pilot Truck

Results

The ElecTruck project was highly successful in its core long term objectives of achieving major technology advances in two key areas: (1) vehicle control and integration and (2) advanced energy storage. More generally, the ElecTruck project

successfully advanced the state of the art in application of electric propulsion technology to Class 8 trucks, and provided valuable lessons learned that enabled TransPower to proceed to even more advanced component and integrated subsystem designs, which – as indicated above – are being incorporated into a growing fleet of fully operational electric Class 8 trucks, tractors, and school buses.

Benefits

The ElecTruck project demonstrated the essential feasibility of eliminating emissions from the largest and most polluting road vehicles, Class 8 trucks. If 5,000 electric trucks of the ElecTruck design were deployed in California by 2020, this would achieve an estimated aggregate emissions reduction of 378,500 tons of carbon per year – a significant step toward achieving the ARB 2020 limit of 427 million tons. Electric trucks of this design also eliminate criteria pollutants at the point of operation and reduce noise.

The project also resulted in valuable lessons learned that will result in future reductions in the costs of manufacturing electric trucks. For example, it was learned that manufacturing costs could be reduced by consolidating power components into a single structure before installing them onto the truck. This resulted in development of a new integrated “Power Control and Accessory Subsystem,” pictured here, which is now being incorporated into all future trucks.

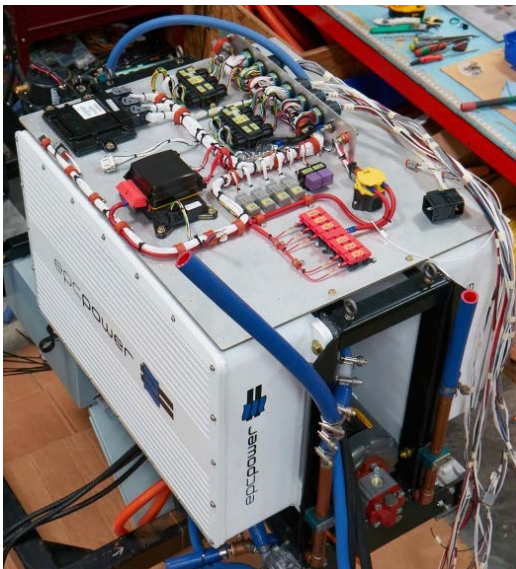

Figure 2: Power Control & Accessory Subsystem

Project Costs

The total cost of the ElecTruck project was approximately \$2,693,939. The SCAQMD contribution to this total was \$496,500, including the \$300,000 pass-through funding from U.S. EPA.

Partner	Contribution
SCAQMD/Clean Fuels Fund	\$196,505
U.S. EPA	\$300,000
CEC	\$1,000,000
TransPower	\$1,197,434
Total Project Costs	\$2,693,939

Total project costs were in line with initial expectations; the project was initially scoped as a \$2 million project that would involve manufacturing of one truck and was expanded to a two-truck project with a total budget of \$2.6 million when the SCAQMD funds were committed. The recurring cost of each truck manufactured with ElecTruck components is presently estimated to be less than \$500,000, and in volume this cost is expected to decline to \$300,000 to \$400,000.

Commercialization and Applications

Technologies and components developed or demonstrated on the ElecTruck project are also being applied to other heavy-duty vehicles, including electric off-road yard tractors and electric school buses. In addition, the ElecTruck project has led to funded efforts to develop a zero-emission range extender for heavy-duty electric trucks, using a hydrogen fuel cell to recharge batteries. These expanded applications and variants of the system demonstrated during the ElecTruck project have the potential to greatly expand the range of commercial applications to which these technologies can be applied.

Upgrade & Install Electric Charging Infrastructure

Contractor

Chargepoint (formerly Coulomb Technologies)

Cosponsor

SCAQMD

Project Officer

Patricia Kwon

Background

There are approximately 1,800 PEV chargers in need of upgrading in the South Coast Air Basin. These sites are ideal locations to upgrade electrical vehicle service equipment (EVSE) for Level 2 charging at a lower cost than to install EVSE at new site locations. Leveraging the DOE and/or CEC funding, SCAQMD executed a contract with Chargepoint to install new or upgraded Level 2 EVSE at high usage site locations identified by SCAQMD and Chargepoint. Chargepoint received DOE and CEC funding to pay for hardware and partial installation costs for Level 2 EVSE at 70 site locations. SCAQMD is providing cofunding of \$1,000 per charger to offset installation costs at these locations. Data will be collected from these chargers and provided to SCAQMD to assist in SCAQMD's PEV infrastructure planning process for the DOE and CEC PEV infrastructure grants for the South Coast region.

Project Objective

SCAQMD executed a contract with Chargepoint to leverage DOE and CEC support for installation of Level 2 EVSE as part of Chargepoint America, a DOE/ARRA project for installation of EVSE in key markets. Chargepoint upgraded existing EVSE which were obsolete and installed new EVSE. Chargepoint submitted a list of approved sites. As part of the SCAQMD program, Chargepoint dedicated full time resources to identify potential site hosts eligible for replacement of obsolete units.

Chargepoint completed installation of 8 of the planned 70 EVSE. Some costs were in excess of

\$1,000, with those costs supplemented by Chargepoint America funding and/or the site hosts. Using the approved site list for sites with obsolete equipment proved challenging. For a three month period, Chargepoint dedicated staff to contact site hosts and owners of obsolete EVSE to assess replacement opportunities. From October 2012 to April 2014, these employees were largely unable to secure approval for replacement of obsolete EVSEs. Some significant challenges encountered were:

- Site hosts did not understand or recognize that the site had EVSE
- Site hosts felt the new EVSE was another passing fad
- Site hosts felt obsolete equipment was not used and new EVSE would be under utilized
- Site hosts felt the EVSE offered little benefit to their business
- Site hosts did not believe enough PEVs existed to support the replacement of EVSE
- Site hosts did not want to enter into business agreements

After attempting to improve contact and replacement of obsolete EVSE through the use of experienced skilled sales and support staff, Chargepoint approached SCAQMD to request approval of funds to contribute to new sites. By agreement, Chargepoint followed the same procedures for submission to SCAQMD and provided site locations for approval or denial. Some prominent locations included workplaces and major destinations including Cedars Sinai Hospital, Disneyland/Downtown Disney, and Burbank Water and Power. All sites are public access.

Technology Description

Level 2 EVSE with J1772 connectors were installed. EVSE were either pedestal mounted or wall mounted depending on the site configuration. As a requirement for new construction and electrical work, permits were required and obtained for projects. There were no significant issues presented with permitting of EVSE.

Status

Chargepoint changed its name from Coulomb Technologies in late 2012. Due to various unforeseen delays, Chargepoint was unable to complete all 70 Level 2 EVSE installations under the original term. In the meantime, fellow EVSE entity ECOTALITY declared bankruptcy and CarCharging Group assumed control of ECOTALITY's assets in late 2013. Clipper Creek was also unable to execute a contract to upgrade 70 Level 2 EVSE. Hence staff executed a new contract with Chargepoint to install 162 Level 2 EVSE in 2015 at workplaces and destinations.



Figure 1: Chargepoint EVSE

Benefits

This project will assist in advancing PEV readiness in California by creating additional public charging that is convenient and affordable for PEV drivers.

Project Costs

EV infrastructure hardware and installation costs were through DOE and CEC funding from Chargepoint America, and remaining installation costs were cost shared between Chargepoint America and the site owner. SCAQMD funding provided \$1,000 per EVSE towards installation costs for a total of \$70,000.

Commercialization and Applications

Level 2 EVSE is currently commercially available, with installations worldwide. Chargepoint America has installed about 20,000 chargers and 3,000 sites in North America, the world's largest charging network. About 25% of these sites are in California.

Results

Chargepoint's Level 2 EVSE installations are shown in the following map:



Figure 2: Chargepoint's Level 2 EVSE Installations

Source: <http://chargepoint.com>

SCAQMD Contract #13149

March 2014

Develop Southern California PEV Readiness Plan

Contractor

UCLA Luskin Center for Innovation (Luskin Center)

Cosponsors

Southern California Association of Governments (SCAG), via award from the CEC
SCAQMD, via award from the U.S. DOE

Project Officer

Patricia Kwon

Background

Every day, more and more plug-in electric vehicles (PEVs) can be spotted on the roads of Southern California. Volatile gasoline prices, state zero emission vehicles programs, federal fuel economy and vehicle emission standards, improved battery technology, and concerns over meeting federal ambient air quality standards and state climate change goals have created a growing market for PEVs.

Project Objective

SCAQMD supported the Luskin Center in development of the *Southern California Plug-In Readiness Plan* and specifically six chapters of this report. These chapters focus on addressing the barriers and opportunities for both workplace and multi-unit dwelling (MUD) charging in Southern California.

Technology Description

PEVs can lower greenhouse gas emissions, improve air quality, increase electric grid efficiency, and reduce fuel costs. PEV deployment, however, will depend in part on how effectively PEV infrastructure is planned. The Luskin Center's PEV Readiness Plan explored the ecosystem of PEV stakeholders whose actions shape the technology's viability and success. This includes various types of property owners (including in the residential and workforce setting) and different levels of government.

Status

The Luskin Center submitted the [*Southern California Plug-In Electric Vehicle Readiness Plan*](#) in December of 2012.

Results

With support from SCAQMD, the Luskin Center completed six chapters in the *Southern California PEV Readiness Plan* consisting of recommendations for stakeholders on the following:

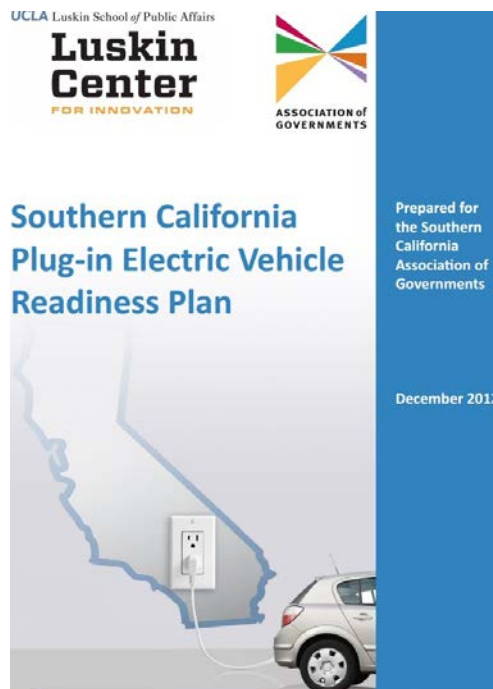

1. Streamlining construction permitting and inspection processes;
2. Updating building codes;
3. Updating zoning and parking rules;
4. Making public charging station site selection (regional planning). This involved creating a methodology and a 3-5yr charging station site plan for deploying workplace and publicly available charging infrastructure; and
5. Creating and implementing a plan for effective marketing and outreach.

Benefits

Since the release of the Southern California PEV Readiness Plan, municipalities and other stakeholders in the South Coast basin have been using the plan and adopting recommendations in it. The plan is helping stakeholders make efficient and effective decisions to support the deployment of clean vehicles that reduce air pollution in the region. The Luskin Center continues to promote the report supported by SCAG and the SCAQMD and educate regional stakeholders about its recommendations.

Project Costs

The costs were estimated to be approximately \$35,000 based on staffing requirements for the six chapters. SCAQMD has agreed to contribute \$32,000. The Southern California Association of Governments contributed the majority of the funding for the project, at nearly \$200,000.

Commercialization and Applications

The main deliverable is a public document.

SCAQMD Contract #15388

December 2014

Participate in California Fuel Cell Partnership for CY 2014 & Provide Support for Regional Coordinator

Contractor

Bevilacqua-Knight, Inc.

Cosponsors

8 automakers; 5 government agencies; 1 technology provider; 9 associate members and 14 affiliate members

Project Officer

Lisa Mirisola

Background

Established with eight members in 1999, the California Fuel Cell Partnership (CaFCP) is a collaboration in which private and public entities are independent participants. It is not a joint venture, legal partnership or unincorporated association. Therefore, each participant contracts with Bevilacqua-Knight, Inc. (BK) for their portion of CaFCP administration. SCAQMD joined the CaFCP in April 2000, and the CaFCP currently includes 37 organizations interested in demonstrating fuel cell vehicle and fueling infrastructure technology.

Project Objectives

Several key goals for 2014:

- Provide education and outreach to support agencies to provide funding opportunities and to encourage transit agencies to become a Center of Excellence. Identify logical options for other heavy-duty fuel cell vehicles;
- Identify, explore and recommend action on issues that help or hinder deployment;
- Begin full implementation of national ER template into existing programs;
- Support station performance codes & standards and activities that improve station performance and development;
- Identify and address key barriers and prepare recommendations to improve timeline to 68 stations. Explore innovative methods of building demand;
- Provide education and training for emergency responders, permittees, and station builders,

including expanding future technician & other training programs;

- Identify and work with the stakeholders and members in early market communities to provide information and resources about fuel cells and hydrogen. Bring in targeted training at right time. Participate in ZEV Action Plan team with OPR and Go-BIZ;
- Conduct one-on-one briefings with California state and federal elected officials, their district and capitol staff and NGOs.
- Raise awareness about the availability and benefits of ZEVs and offer driving opportunities. Provide outreach and education through events, materials, video, web and social media that increase awareness, build support in early market communities and support other projects' specific goals.

Status

The members of the CaFCP intend to continue their cooperative demonstration efforts and have set goals through 2016, subject to a budget approved annually. This final report covers the SCAQMD Contract #15388 for 2014 membership. This contract was completed on schedule.



Congressman Mark Takano talks to SunLine Transit general manager Lauren Skiver during CaFCP-organized tour of four fuel cell electric buses under construction at Eldorado facility in Riverside. State Senator Richard Roth and ARB staff also attended.

Technology Description

The CaFCP members together or individually are demonstrating fuel cell passenger cars and transit buses and associated fueling infrastructure in

California. The passenger cars include Daimler's B Class F-CELL, GM's Chevy Fuel Cell Vehicle, Honda's FCX Clarity, Hyundai's Tucson, Nissan's XTrail, Toyota's FCHV-adv and VW/Audi's Golf Sportwagen HyMotion and A7 h-tron. The fuel cell transit buses include 12 placed at AC Transit (Van Hool buses with UTC fuel cells) and 4 placed at Sunline Transit (1 Ballard/New Flyer and 3 Ballard/BAE/EIDorado).

Results

Specific accomplishments include:

- Automotive members placed over 500 fuel cell passenger vehicles on California roads from 1999 through 2014, including the first retail customers starting in 2005;
- Transit agency members have demonstrated 25 fuel cell buses since 1999, with 16 currently in operation (see technology description);
- There are eight public hydrogen fueling stations in operation in California. There are also 49 in development in California;
- CaFCP staff and members continue to train local fire departments and work with emergency response organizations to coordinate with state and national efforts;
- CaFCP, the Governor's Office of Business and Economic Development and the California Energy Commission, began briefing city staff across California state to optimize station permitting.
- CaFCP, GO-BIZ, CEC and others, hosted briefings and permitting workshops across the state for local government staff and elected officials.

Benefits

Compared to conventional vehicles, fuel cell vehicles can offer zero or near-zero smog-forming emissions, reduced water pollution from oil leaks, higher efficiency and much quieter and smoother operation. If alternative or renewable fuels are used as a source for hydrogen, fuel cell vehicles will also encourage greater energy diversity and lower greenhouse gas emissions (CO₂).

By combining efforts, the CaFCP can accelerate and improve the commercialization process. The members have a shared vision about the potential of fuel cells as a practical solution to California's environmental issues and similar issues around the world. The CaFCP provides a unique forum where technical and interface challenges can be identified

early, discussed, and potentially resolved through cooperative efforts.

Project Costs

Auto members provide vehicles, the staff and facilities to support them. Energy members engage in fueling infrastructure activities. The CaFCP's annual operating budget is about \$2 million, and includes facility operating costs, program administration, joint studies and public outreach and education. Each member makes an annual contribution of approximately \$88,000 towards the common budget. Some government agencies contribute additional in-kind products and services. SCAQMD provides an additional \$50,000 annually to support a Southern California Regional Coordinator and provides office space for additional staff in-kind at SCAQMD. SCAQMD's contribution for 2014 was \$137,800.

Commercialization and Applications

While research by multiple entities will be needed to reduce the cost of fuel cells and improve fuel storage and infrastructure, the CaFCP can play a vital role in demonstrating fuel cell vehicle reliability and durability, fueling infrastructure and storage options and increasing public knowledge and acceptance of the vehicles and fueling.

From 2013 to 2016, CaFCP's goals relate to Preparing for Market Launch through coordinated individual and collective effort. During this fourth phase, CaFCP members, individually or in groups, will focus on important goals.

- Prepare for larger-scale manufacturing, which encompasses cost reduction, supply chain and production.
- Work on the customer channel, including identifying and training dealers and service technicians.
- Reduce costs of station equipment, increase supply of renewable hydrogen at lower cost, and develop new retail station approaches.
- Support cost reduction through incentives and targeted RD&D projects
- Continue research, development and demonstration of advanced concepts in renewable and other low-carbon hydrogen.
- Provide education and outreach to the public and community stakeholders on the role of FCEVs and hydrogen in the evolution to electric drive.

Develop & Demonstrate Hydrogen ICE Vehicles for Five Cities Program

Contractor

Quantum Fuel Systems Technologies Worldwide, Inc.

Cosponsor

SCAQMD

Project Officer

Patricia Kwon

Background

This program was part of a larger demonstration of hydrogen internal combustion vehicles (ICE) and infrastructure started in 2003. SCAQMD initiated an effort to establish a network of hydrogen fueling stations and several fleets consisting of vehicles equipped with hydrogen powered internal combustion engines. To date, the high cost and limited availability of fuel cell vehicles have been a limiting factor in the deployment of hydrogen infrastructure. It is anticipated that hybrid electric and conventional vehicles equipped with hydrogen fueled internal combustion engines will stimulate the demand for hydrogen, expedite the development of infrastructure and provide a bridge to fuel cell vehicles. Conventional and hybrid electric vehicles equipped with hydrogen powered internal combustion engines have the potential to eliminate VOC, CO and CO₂, and significantly reduce NO_x and air toxics.

Project Objective

This program consisted of 30 model year 2004 Toyota Prius vehicles, located at five cities (Santa Monica, Burbank, Santa Ana, Riverside, and Ontario) and SCAQMD Headquarters, all within the South Coast Air Basin in Southern California. Each city was also awarded a hydrogen fueling station to provide fuel for the five hydrogen vehicles located within each particular city. The plan was that this initial hydrogen program consisting of stations and vehicles would spur additional hydrogen infrastructure to be established within the SCAQMD region.

Technology Description

The engine development and calibration on the Prius was developed around the Quantum engine controller and Quantum experience using gaseous fueled engines. On this program there was not support from Toyota for the calibration of the engine control. This drove Quantum to use the Huntington engine controller and implement this as an add-on controller. The control strategy for the engine was to use a lean-burn approach to avoid a high level of NO_x emissions that are typically associated with combustion engines.

Emission testing was performed periodically on all vehicles to ensure compliance with SULEV standards. This program was limited in scope with respect to On Board Diagnostics (OBD) due to the lack of OEM level support to tie directly into the engine ECU and modify the OBD algorithms, calibration and add enhancement for gaseous fuels. The vehicles have limited OBD features, as described below but are not fully OBD-II compliant. Quantum has done a significant amount of work to make the vehicle as compliant as possible with current OBD-II requirements.



Figure 1: 2008 Toyota Prius Converted to Operate on Hydrogen Fuel

Status

Vehicles were converted and deployed between December 2005 and March 2006 and a CARB experimental permit was issued for five years. An extension of this experimental permit obtained two more years, and then a third extension of the

experimental permit was obtained for seven vehicles until April 2014. Four of SCAQMD’s vehicles were transferred to DOE Sandia and Livermore Laboratories for demonstrating hydrogen storage technologies, and one vehicle was transferred to California State University Los Angeles for testing their upgraded hydrogen station. The remaining vehicles had hydrogen system components removed and were crushed according to the terms of the experimental permit.

Results

All of the emission testing for the program was conducted at the Quantum SULEV emissions lab. This is a laboratory grade test facility which is recognized by both CARB and U.S. EPA. The vehicle was run through all of the mandatory emissions tests to ensure compliance with the applicable SULEV standards. The vehicles were also tested on a regular basis in compliance with the CARB experimental permit.

The fleet was polled in March 2012 for the current mileage of their vehicles. The table below shows the mileage of each fleet. Ontario and Santa Monica had previously reported their data to SCAQMD (8/2011 and 3/2010 respectively). The bottom row shows the average mileage for each cities hydrogen fleet. The vehicle mileages that are highlighted indicate vehicles that continued operation beyond March 2012.

Table 1: Mileage by City

AQMD (3/12)	Burbank (3/12)	Ontario (8/11)	Riverside (3/12)	Santa Ana (3/12)	Santa Monica (3/10)
6,083	7,748	8,097	8,080	5,136	7,789
9,765	23,916	5,448	11,154	7,772	5,211
8,794	10,993	5,941	7,886	5,392	13,699
6,712	8,480	7,709	15,015	5,143	4,349
10,519	6,563	5,405	--	6,900	6,468
8,375	11,540	6,520	10,534	6,069	7,503

Over the course of the five year service and maintenance program, Quantum performed numerous repairs on the fleet. Below is a summary of each repair performed on the fleet. Spark plugs were by far the most frequently serviced item, as they fouled due to water in the combustion chamber coming into contact with the spark plug tip (or electrode). Rust around the electrode would cause the spark plug to fail, and the vehicle would immediately begin running rough.

Table 2: Common Types of Vehicle Repairs

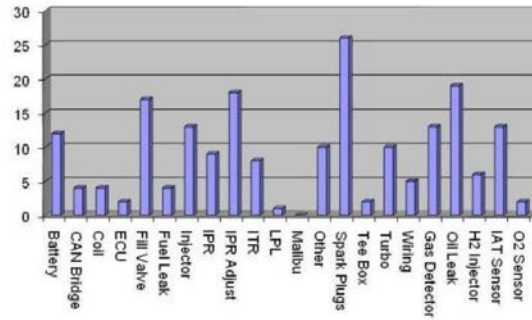

Benefits

The Five Cities program successfully demonstrated interim hydrogen fuel vehicle technology and infrastructure (electrolyzers and mobile fuelers), and was one of the largest scale combined vehicle and infrastructure deployments when the project was funded in 2004. It accelerated the development of a sustainable hydrogen market by demonstrating the feasibility of hydrogen as a vehicle fuel while directly reducing vehicle pollutants, greenhouse gas emissions, and petroleum usage. These vehicles displayed a Clean Fuel decal and were extensively used for public outreach events (e.g., public meetings, conferences, automobile shows, etc.), as well as education and training at local high schools and universities in order to expose the next generation of clean technologies.

Project Costs

Total cost was \$2.35 million for this vehicle project, all contributed by SCAQMD. The hydrogen station portion of this project, through a separate contract with Air Products and Chemicals, Inc., again fully funded by SCAQMD, was \$4.16 million (comprising construction, maintenance and closing costs).

Commercialization and Applications

Quantum recognized the challenges of developing a fully OBD-II compliant conversion on a commercially available vehicle, and suggested that future conversions also have the support of the vehicle OEM as part of the team that develops the conversion. Some support from the OEM can significantly reduce the conversion time, and complexity of the conversion, along with ensuring the final product is fully OBD-II compliant.

Study Sources, Composition, Variability & Toxicological Characteristics of Ultrafine Particles in Southern California

Contractor

University of Southern California

Cosponsor

SCAQMD

Project Officer

Jean Ospital

Background

Many of the health effects associated with exposure to particulate matter (PM) derive from the ability of PM to generate oxidative stress. Ultrafine particles (UFP) ($d_p < 0.1\text{--}0.2\ \mu\text{m}$), in particular, may be more toxic than coarse or fine PM. Despite their very low contribution to PM mass, UFP dominate particle number concentrations as well as have a large surface area relative to fine or coarse particles and a high pulmonary deposition efficiency. These particles can thus carry considerable amounts of toxic air pollutants, such as organic carbon and transition metals.

Project Objective

24-hour time-integrated samples were concurrently collected once a week for a year-long period at 10 distinctly different areas across the Los Angeles Basin, followed by comprehensive chemical and toxicological analyses, to provide insight on the seasonal and spatial variability in the chemical composition, sources and oxidative potential of quasi-UFP ($\text{PM}_{0.25}$, $d_p < 0.25\ \mu\text{m}$)

Method Description

Sites included source, near-freeway, semi-rural receptor and desert locations. They can be classified according to their geographical location into Long Beach (HUD), western LA (GRD, LDS), central LA (CCL, USC), eastern LA (HMS, FRE), Riverside County (VBR, GRA) and Lancaster (LAN); in respective order of their increasing distance from the coast. Sources

contributing to total and elemental mass of quasi-UFP were determined using a molecular marker-based chemical mass balance (MM-CMB) model and principal component analysis (PCA), respectively. Redox activity of the PM samples was measured using both chemical (dithiothreitol (DTT) assay) and cell-based macrophage (reactive oxygen species (ROS) assay) assays. The association of oxidative potential with chemical species and sources was evaluated using univariate and multivariate regression analyses. Furthermore, ROS-activity levels of quasi-UFP in Los Angeles were compared across different seasons, worldwide urban locations and particle-size fractions. The impact of atmospheric aging on quasi-UFP PM oxidative potential was also investigated.

Status

This project is completed and a list of relevant publications are attached to this report. A few additional field experiments were run with the aim of evaluating the effect of atmospheric aging on the oxidative potential of ultrafine particles, which are a very minor and mostly confirmatory part of the study, and are expected to be completed by the Spring of 2015.

Results

Average $\text{PM}_{0.25}$ mass concentration ranged from 5.9 to 16.1 $\mu\text{g}/\text{m}^3$ across the basin and seasons. Wintertime levels were highest at the source HUD site, while lowest at the desert-like LAN site. On the other hand, summertime concentrations peaked at the inland receptor locations. Chemical mass closure showed that that quasi-UFP in the basin consisted of 49–64% organic matter, 3–6.4% elemental carbon (EC), 9–15% secondary ions (SI), 0.7–1.3% trace ions, and 5.7–17% crustal material and trace elements, on a yearly average basis.

Among all measured organic compounds, n-alkanes, which were predominantly of anthropogenic source (carbon preference index (CPI) ~ 1), were the most abundant species in

PM_{0.25} with cumulative levels ranging from 9.34 to 48.08 ng m⁻³ over all sites and seasons. Seasonal averages of total polycyclic aromatic hydrocarbons (PAHs), hopanes and steranes, molecular markers of vehicular emissions, were highest in winter while lowest in summer. Primary sources, which were determined using the MM-CMB model, included mobile sources (combined gasoline and diesel vehicles), wood smoke, natural gas combustion, vegetative detritus, and ship emissions. To characterize sources of trace elements and metals, PCA was applied to site-pooled elemental data as well as urban and rural receptor site clusters. Five major sources were identified, including road dust (influenced by vehicular emissions as well as re-suspended soil), vehicular abrasion, residual oil combustion, cadmium sources and metal plating. These sources collectively accounted for about 85% of the total variance of quasi-UFP elemental content.

The redox activity of PM_{0.25} samples was also assessed by means of a biological ROS assay (generation of ROS in rat alveolar macrophage cells). Seasonally, fall and summer displayed higher volume-based ROS-activity (i.e. ROS-activity per unit volume of air) compared to spring and winter. ROS levels were generally higher at near source and urban background sites compared to rural receptor locations, except for summer when comparable ROS-activity was observed at the rural receptor sites.

A multivariate regression method was also used to obtain a model for predicting the ROS-activity of PM_{0.25}, based on its water-soluble components. The most important species associated with ROS were Cu and La at the source site of Long Beach, and Fe and V at urban LA sites. These metals are tracers of road dust enriched with vehicular emissions (Fe and Cu) and residual oil combustion (V and La). At Riverside, a rural receptor location, WSOC and Ni (tracers of SOA formation and metal plating, respectively) were the dominant species driving the ROS-activity. To further investigate the potential role of water-soluble and water-insoluble portions of ambient PM in the potential toxicity of PM, size-fractionated ambient particle samples (coarse, fine and ultrafine PM) were collected in August-September of 2012 at the urban USC site, using the Versatile Aerosol Concentration Enrichment System (VACES)/BioSampler tandem system. While water-soluble species contribute to the large majority of the ROS-activity per volume of sampled air, high intrinsic ROS-activity (i.e. PM mass-normalized) is observed for the water-insoluble portions. Organic compounds in both water-soluble and water-insoluble portions of ambient PM, as well as transition metals, several with recognized redox activity (Mn, V, Cu and Zn), are highly correlated with ROS-activity.

Benefits

Findings help establish the association between sources, composition and toxicity of UFP and provide a strong scientific basis for developing more targeted and cost-effective regulatory strategies at both the federal and state level. Moreover, the extensive database on UFP generated from this project constitutes an invaluable resource to PM exposure and health studies in the L.A. Basin.

Project Costs

Total estimated project cost was \$470,969, including \$300,000 in U.S. EPA funding through a pass-through contract. Final cost of the project is pending final invoice and financial close out by the USC Office of Sponsored Projects.

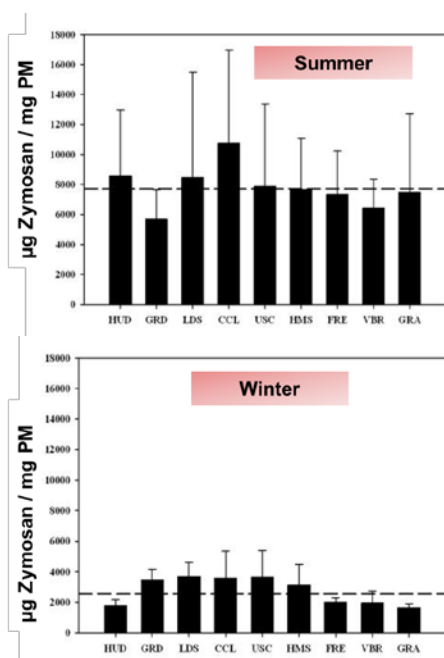

Health Effects of PM Emissions from Heavy-Duty Vehicles – A Comparison Between Different Biodiesel Fuels

Contractor

University of California Riverside

Cosponsor

SCAQMD

Project Officer

Brian Choe

Technology Description

Experiments were conducted with two heavy-duty diesel vehicles: a MY 2002 truck without any emission control technologies and a MY 2010 truck fitted with a diesel oxidation catalyst (DOC) followed by a diesel particle filter (DPF) and selective catalytic reduction (SCR) to comply with current U.S. EPA emissions standards. The biodiesels tested include a soy-based methyl ester (SME), a waste cooking oil methyl ester (WCO), and a methyl ester obtained from animal fat (AFME). The biodiesels were blended at a 50% proportion by volume with the CARB ULSD. The vehicles were tested on a heavy-duty chassis dynamometer at the UCR facility over the EPA UDDS test cycle to measure: 1) regulated emissions; 2) unregulated emissions such as ammonia, carbonyl compounds, and volatile organic compounds; 3) the physical properties of PM emissions (e.g., PM mass, number, and size distributions); 4) the chemical properties of PM emissions (e.g., PAHs, WSOC, inorganic ions, organic compounds, and metals); and 5) the toxicological characteristics of PM emissions (e.g., redox activity, electrophilic properties, and pro-inflammatory properties).

Background

Governmental agencies around the world have been implementing legislation that targets growing the use of renewable fuels in the transportation sector. In the U.S., the Energy Independence and Security Act of 2007 mandate the use of 36 billion gallons of biofuels in the transportation fuel pool by 2022. In California, the low carbon fuel standard (LCFS) was implemented in 2011 to promote the reduction of greenhouse gas emissions by targeting a reduction in the carbon intensity of transportation fuels by 10% by 2020. In addition, the implementation of more stringent standards for heavy-duty vehicles is a key strategy for the improvement of air quality in the SCAQMD. These facts, coupled with the continuously growing concern over global warming and environmental degradation, have accentuated public and scientific awareness and led to a substantial effort to develop alternative fuel sources including biofuels and to improve engine technologies.

Project Objective

The main goal of this study was to investigate the physical and chemical properties as well as toxicological characteristics of PM emissions from heavy-duty vehicles operating on various types of biodiesel blends to evaluate the air quality impacts and associated health risks from the use of biodiesel as a transportation fuel.

Status

This project was completed in March of 2014. The results have been presented at several conferences and in an SAE technical paper with two additional peer review journal articles being prepared for publication.

Results

THC, NMHC, CO, and PM mass emissions showed reductions with the use of biodiesel blends for the uncontrolled 2002 truck. These phenomena can be explained by the higher oxygen content in the methyl ester moiety which helps reduce rich combustion zones and promote more complete combustion and reduce the sooting tendency of biodiesel. For the heavily controlled 2010 truck, THC, NMHC, CO, and PM emissions

were very low due to the DOC/DPF system, and did not show any strong fuel effects.

Overall, NO_x emissions exhibited increases with the use of biodiesel for both vehicles, with the differences in NO_x emissions relative to CARB ULSD being statistically significant for the 2010 truck. In addition, NO_x emissions showed some feedstock dependency with the unsaturated SME-50 producing higher NO_x than the more saturated AFME-50 blend.

Particle number emissions did not show any strong fuel effects for the 2002 truck while they were below the tunnel background levels for the 2010 truck. As for particle distributions, CARB ULSD produced more accumulation mode particles compared to biodiesel blends while the more unsaturated SME-50 showed higher nucleation mode particle counts relative to CARB ULSD and other biodiesel blends.

Ammonia emissions were significantly higher for the SCR-fitted vehicle. This is likely due to the use of urea injection to suppress NO_x emissions. Biodiesel blends also produced higher NH₃ emissions in comparison to the baseline CARB ULSD.

Overall, the use of biodiesel resulted in decrease of PAHs. For the 2002 truck, biodiesel blends reduced PAH emissions, although the absence of emission aftertreatment technologies led to greater levels of higher molecular weight PAHs. For the heavily controlled 2010 truck, most PAH compounds were practically undetectable as a result of the DOC/DPF system although some light molecular-weight PAHs were detected.

The redox activity measured with the macrophage ROS assay did not show any strong fuel trends for either test vehicle whereas the oxidative potential, as measured with the DTT assay, showed some large reductions with the use of biodiesel blends relative to CARB ULSD for the 2002 truck. The DTT assay showed that biodiesel exhaust was less potent than CARB ULSD. This observation was supported by the vapor-phase PM results where the redox activity of biodiesel blends was lower than for CARB ULSD. For the 2010 truck, the DTT values for the particle-phase components were well below the filter blank levels due to the very low PM mass.

To assess the inflammatory response of diesel and biodiesel blends for both vehicles, the expression of cytokine tumor necrosis alpha (TNF- α) by a mouse macrophage cell line (Raw 264.7) was

used. The PM samples from the 2002 truck were capable of increasing TNF- α while the PM samples from the 2010 truck exhibited very low activity. The vapor-phase samples, on the other hand, showed high negative values that we hypothesize are real and important effects, which could reflect suppression of the TNF- α response.

To assess the protective response of diesel and biodiesel blends for both vehicles, the cellular hemeoxygenase-1 (HO-1) expression was determined. The biodiesel particle-phase samples collected from the 2002 truck increased the expression of HO-1 at greater levels than those exhibited by the CARB ULSD. In contrast to the particle-phase PM samples, the vapor-phase samples collected showed greater expression of HO-1 for the CARB ULSD than the biodiesel blends.

The DTT redox activity of the emitted PM was found to correlate well with the WSOC, the redox-active transition metals, alkanes, hopanes and steranes. This indicates that these species are likely to be involved in the oxidation stress mechanism by the generation of ROS.

Benefits

The information obtained from this program will be valuable in evaluating and mitigating any potential air quality impacts from the increased use of biodiesel. By understanding the impacts of alternative fuels on vehicle emissions, we can better ensure these fuels can be implemented in a way that preserves or improves air quality, while meeting goals for petroleum displacement and reductions in greenhouse gases.

Project Costs

The project cost was \$207,500 funded by the SCAQMD.

Commercialization and Applications

Currently, there is insufficient information to fully understand the air quality impacts of widespread implementation of biodiesel. This research will have important implications for the expanded use of biodiesel in commercial vehicles, and what impacts this might have on vehicle performance.

SCAQMD Contract #09304

December 2014

Install & Evaluate Two 40kW (AC) PV Systems at SCAQMD Headquarters

Contractor

Solar Integrated Technologies, Inc.

Consponsor

SCAQMD

Project Officer

Patricia Kwon

laminates use a thin stainless steel substrate that is produced through a proprietary continuous vapor deposition process. The BIPV panels weigh 12 ounces per square foot and are suitable for lightweight structures. BIPV is known for its ability to utilize a wider spectrum of light for increased power output during cloudy, low-light conditions. The BIPV system was installed at a zero degree tilt.

Background

On October 3, 2008, the SCAQMD Board approved the execution of contracts to install two new photovoltaic (PV) systems at the SCAQMD facility in Diamond Bar, CA. One is a conventional multi-crystalline silicon PV system and the other is a building integrated PV (BIPV) system. The SCAQMD currently owns and operates two solar electric systems, including an 80 kW (AC) PV system on the main building and a 20 kW PV system on a carport in the parking lot.



Solar Roof Panels on SCAQMD Building

Project Objectives

The objective of this project is to compare the performance of BIPV and crystalline silicon PV systems, as well as add solar capacity and generate additional clean, renewable electricity for the facility. The project involves a demonstration of two different PV technologies on the same roof above the conference center. SCAQMD will test the performance and reliability of the two systems under similar light conditions for a period of at least five years.

Technology Description

The BIPV system combined a Sarnafil thermoplastic PVC roofing membrane and a Uni-Solar amorphous silicon PV laminate. The BIPV panels were welded together at Solar Integrated's (SIT's) manufacturing facility in Los Angeles. The roofing membrane has a class A fire rating, is resistant to water and bacterial growth, and energy efficient (listed under U.S. EPA's Energy Star program). The amorphous thin film silicon

Status

This installation was completed and on June 17, 2009, the system was turned on, following approval for interconnection by Southern California Edison. Edison approved the payment of the first monthly performance based incentive (PBI) check on November 23, 2009. During and after installation, several problems arose.

Since there were two separate systems and one rebate, the project had to combine the single lines. It was solved by working with SIT's engineer and teamwork. SCAQMD's single line diagram was several years old and did not include four of its turbine engines. When the issue was uncovered, it was resolved by updating the single line for the entire building to include the two PV systems.

SIT was contracted to re-roof underneath the modules and ended up putting more modules down.

Edison mandated a \$1,041 new meter charge that was previously unknown. This problem is being solved by splitting the cost between PermaCity and SIT.

to mass production of solar modules making them an affordable, widely available commercial product.

Monitoring and the SCAQMD kiosk have been an ongoing challenge. Working together, SCAQMD, Fat Spaniel, and PermaCity now have the monitoring system and kiosk running. The kiosk shows the performance of the two new solar PV installations as well as the first 80 kW solar PV installation. Testing of the performance and reliability of the two systems continued under similar light conditions for five years after installation.

Results

The BIPV system is projected to produce 77,672 kWh annually, with an estimated annual cost savings in electricity of \$11,000. Production data for both systems are below.

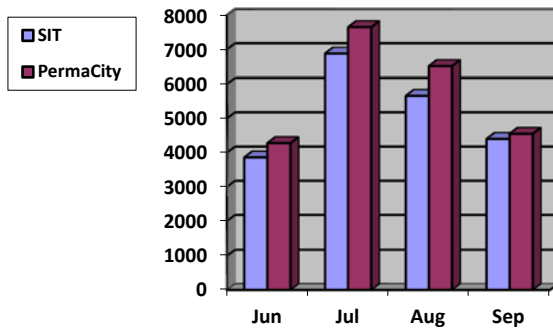

Benefits

Estimated CO2 reductions for both solar PV installations are approximately 78 tons/year using the California GREET model. ([Environmental impacts of PV electricity generation - a critical comparison of energy supply options](#))

Project Cost

The total project cost for the PV system installation was \$390,695. All funds were paid by the SCAQMD.

Commercialization and Applications

Both crystalline and thin film solar modules are already commercial products. They have both demonstrated their efficacy and applications in the renewable energy generation field. The increased demand for renewable energy has led

SCAQMD Contract #13078

December 2014

Steam Hydrogasification Process Demonstration

Contractor

University of California Riverside

Cosponsors

CEC
SCAQMD

Project Officer

Brian Choe

Background

Utilization of renewable energy sources is an integral part of California's strategy to reduce greenhouse gas emissions and to diversify domestic energy sources. Renewable Natural Gas (RNG) can be produced from carbonaceous and renewable feedstocks through a number of technologies including anaerobic digestion, landfill gas collection, gasification and pyrolysis. However, these technologies are often inefficient and the product gas is typically of low quality and inferior to fossil source-based natural gas. The Steam Hydrogasification Reaction (SHR), which has been developed by UCR, is a thermochemical process that can produce high quality RNG from organic waste in a cost-effective and efficient manner. The SHR is also capable of handling wet feedstocks providing an attractive option to utilize solid waste with high moisture contents such as biosolids from wastewater sludge that pose more environmental challenges and issues in disposal.

Project Objective

The objective of this project was to demonstrate the SHR system in a Process Development Unit (PDU) scale reactor to produce RNG from wet organic waste, namely biosolids comingled with food and green waste, to validate and refine the process and develop a preliminary engineering design for a pilot plant.

Technology Description

SHR is a thermochemical process to produce high quality RNG from organic waste in a hydrogen rich environment. The process can

handle wet feedstock without drying, does not require an expensive oxygen plant, and operates at relatively lower temperatures compared to conventional gasification processes. In addition, the SHR utilizes steam in the reactor to enhance the rate of methane formation.



Figure 1: PDU SHR-WGS System

The reactor system used for this experiment was a PDU with a 5 lb/hr feed rate consisting of a bubbling fluidized bed SHR and a fixed bed type water gas shift reactor (WGS) to increase the methane production. The PDU was used to convert slurry composed of biomass and bio solids into a syngas and eventually to RNG. The slurry is fed into the PDU by a rotating auger through a 1-inch tube which enters the SHR reactor above the fluidized bed. When the slurry reaches the reaction zone, it reacts with hydrogen and water to produce methane, CO and CO₂. Once the product gas leaves the reaction zone, it passes through a cyclone to separate out solid particles from the product gas stream. The product gas then passes through the WGS to be further converted into methane rich gas. A heat exchanger then cools down the gas to about room temperature condensing steam back into water. The dry gas is then further processed and compressed into high quality RNG. For this project, a gas recirculation loop was designed and added to recycle internally generated hydrogen back to the reactor for a self-sustained operation without external hydrogen supply.

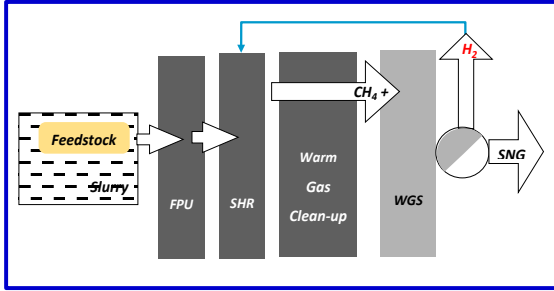

Figure 2: SHR-WGS Process Diagram

Status

This project was completed in November 2014 and a final report is on file with complete technical details and findings.

Results

The demonstration yielded a final gas composition of 73% CH₄ and 27% CO after CO₂ separation (43% CH₄, 16% CO and 41% CO₂ before CO₂ separation). The methane content can be further increased close to 90% through additional methanation process. Carbon conversion efficiency was 75% meaning that 75% of carbon in the feedstock was utilized to produce the product gas. Remaining 25% was converted into char which can be utilized as fuel for heat source. Through this project, the process condition was optimized at 1.0 H₂/C mole ratio, 1.5 H₂O/feedstock mass ratio, nominal reactor temperature of 750oC and pressure of 400 psia, and 320-380oC WGS operation temperature.

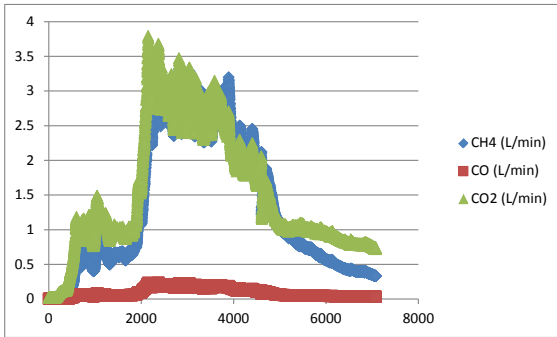

Figure 3: Product Gas Composition

Based on the demonstration results, a preliminary engineering design was developed for a 5 ton/day pilot plant to produce 20,000 diesel equivalent gallons of RNG annually. In addition, an economic analysis for a commercial scale plant was also performed. The analysis showed that the RNG production cost will range

from \$5 to \$15/MMBtu depending on site capacity and applications.

Benefits

Biofuels derived from waste-based feedstocks typically have lower carbon intensities compared to other biofuels and alternative fuels. The SHR process has demonstrated potentials to produce high quality RNG from biomass waste more efficiently than competing renewable fuels and energy technologies including anaerobic digestion. Based an estimate of green waste and biosolid resources that can be technically converted into RNG, a wide-scale implementation of this technology can help to replace about 4.9% of the natural gas consumption in California.

Project Costs

The total project cost was approximately \$922,000. SCAQMD funded \$72,916 leveraging cost shares from project partners including \$650,000 from CEC.

Commercialization and Applications

For the next phase, a demonstration with a circulated fluidized bed reactor to simulate a real world operation is recommended to validate and refine the pilot plant design. A successful validation of the process will then lead to a pilot plant demonstration at the Riverside Waste Quality Control Plant.

Appendix D

List of Acronyms

LIST OF ACRONYMS

AFRC—air/fuel ratio control	GC/MS—gas chromatography/mass spectrometry
AFVs—Alternative Fuel Vehicles	GGE—gasoline gallon equivalents
APCD—Air Pollution Control District	GHG—Greenhouse Gas
AQMD—Air Quality Management District	GTL—gas to liquid
AQMP—Air Quality Management Plan	H&SC—California Health and Safety Code
ARB—Air Resources Board	HCCI—Homogeneous Charge Combustion Ignition
ARRA—American Recovery & Reinvestment Act	HCNG—hydrogen-compressed natural gas (blend)
AWMA—Air & Waste Management Association	HDDT—highway dynamometer driving schedule
BACT—Best Available Control Technology	HD-FTP—Heavy-Duty Federal Test Procedure
BSNO _x —brake specific NO _x	HDV—heavy-duty vehicle
BMS—battery management system	HEV—Hybrid electric vehicle
CAAP—Clean Air Action Plan	HPDI—High Pressure Diesel Injection
CAFR—Comprehensive Annual Financial Report	HT—high throughput
CARB—California Air Resources Board	HTPH—high throughput pretreatment and enzymatic hydrolysis
CATI—Clean Air Technology Initiative	ICE—internal combustion engine
CCF—California Clean Fuels	ICEV—internal combustion engine vehicle
CDFA/DMS—California Department of Food & Agriculture/Division of Measurement Standards	ICTC—Interstate Clean Transportation Corridor
CEC—California Energy Commission	LCFS—Low Carbon Fuel Standard
CE-CERT—College of Engineering – Center for Environmental Research and Technology	Li—lithium ion
CEMS—continuous emission monitoring system	LIMS—Laboratory Information Management System
CFCI—Clean Fuel Connection, Inc.	LNG—liquefied natural gas
CFD—computational fluid dynamic	LPG—liquefied petroleum gas or propane
CNG—compressed natural gas	LSV—low-speed vehicle
CO ₂ —carbon dioxide	MATES—Multiple Air Toxics Exposure Study
CO—carbon monoxide	MECA—Manufacturers of Emission Controls Association
CRT—continuously regenerating technology	MPEFI—Multi-Port Fuel Injection
DC—direct connection	MPG—miles per gallon
CY—calendar year	MSRC—Mobile Source Air Pollution Reduction Review Committee
DCM—dichloromethane	MSW—municipal solid wastes
DEG—diesel equivalent gallons	MY—model year
DGE—diesel gallon equivalents	MTA—Metropolitan Transportation Authority (Los Angeles County “Metro”)
DF—deterioration factor	NAFA—National Association of Fleet Administrators
DMS—Division of Measurement Standards	NCP—nonconformance penalty
DMV—Department of Motor Vehicles	NEV—neighborhood electric vehicles
DOC—diesel oxidation catalysts	NextSTEPS—Next Sustainable Transportation Energy Pathways
DOE—Department of Energy	NGV—natural gas vehicle
DOT—Department of Transportation	NHTSA—National Highway Traffic Safety Administration
DPF—diesel particulate filters	NMHC—non-methane hydrocarbon
DRI—Desert Research Institute	NO—nitrogen monoxide
ECM—emission control monitoring	NO ₂ —nitrogen dioxide
EGR—exhaust gas recirculation	NO + NO ₂ —nitrous oxide
EPRI—Electric Power Research Institute	NOPA—Notice of Proposed Award
ESD—emergency shut down	NO _x —oxides of nitrogen
EV—electric vehicle	NREL—National Renewables Energy Laboratory
FCV—fuel cell vehicle	OBD—On-Board Diagnostics
FTA—Federal Transit Administration	
FTP—federal test procedures	
g/bhp-hr—grams per brake horsepower per hour	

LIST OF ACRONYMS (cont'd)

OCTA—Orange County Transit Authority
OEM—original equipment manufacturer
PAH—polyaromatic hydrocarbons
PbA—lead acid
PCM—powertrain control module
PEMFC—proton exchange membrane fuel cell
PEV—plug-in electric vehicle
PHEV—plug-in hybrid vehicle
PM—particulate matter
PM_{2.5}—particulate matter ≤ 2.5 microns
PM₁₀—particulate matter ≤ 10 microns
ppm—parts per million
ppb—parts per billion
RDD&D—research, development, demonstration
and deployment
RFS—renewable fuel standards
RI—reactive intermediates
RRC—rolling resistance co-efficient
RTA—Riverside Transit Agency
SCAB—South Coast Air Basin or “Basin”
SCAQMD—South Coast Air Quality Management
District
SCE—Southern California Edison
SCR—selective catalytic reduction
SI—spark ignited
SIP—State Implementation Plan
SoCalGas—Southern California Gas Company (A
Sempra Energy Utility)
SULEV—super ultra-low emission vehicle
TAO—Technology Advancement Office
TC—total carbon
THC—total hydrocarbons
TO—task order
TRB—Transportation Research Board
TSI—Three Squares, Inc.
UDDS—urban dynamometer driving schedule
µg/m³—microgram per cubic meter
U.S.EPA—United States Environmental Protection
Agency
U.S. —United States
ULEV—ultra low emission vehicle
VMT—vehicle miles traveled
VOC—volatile organic compounds
WVU—West Virginia University
ZEV—zero emission vehicle